

JEPSON POWER[®]
Leading Through Innovation
GERMANY



THE ORIGINAL
www.drycutter.com

JEPSON POWER[®]
Leading Through Innovation
GERMANY

The Catalog





1984 THE FIRST DRY CUTTER

Jepson Power „Leading Through Innovation ...“

Since 1984 this has been the guiding principle of Jepson Power, the inventor of dry cutter technology, innovative, high-quality machines and saw blades for processing metals and composites. With our technology, the sawing process is fast, almost burr-free, without cooling and with a long service life. Thanks to many years of experience, competent product consultants and a Research & Development department, Jepson Power is able to develop innovative and tailor-made solutions such as specially coated saw blades.

For us, innovation means constantly improving our products, providing targeted user-friendliness and excellent service. This is based on our continuous investment in research and development. It is our goal in the future to set new standards in the industry with our dry cutter technology. Forward-looking innovations, as we did through pioneering work in the 80s, underline our position as a leader.

From the idea to technology, that's what we stand for. With this claim, Jepson Power achieved market leadership with its Dry Cutter technology in its well-known yellow-blue colors.

The next generations of our dry cutter machines with their unique saw blades are already being developed and tested in our German production facility in Eschweiler. Our daily incentive: to saw faster, achieve better tool life and larger cutting areas! As the world market leader in the field of high-speed carbide-tipped saw blades and one of the world market leaders in the field of portable power tools, it is our constant endeavor to continue developing the best possible and most innovative products based on the highest quality standards.

**Pierre Michiels
CEO**

CONTENT

OVERVIEW	4 - 9
• Saw blades	4
• Dry Cutter Machines	6
• Magpro Core Drilling Machines	8
DRYTECH® SAW BLADES	10 - 17
• Carbide tipped saw blades for metal	10
• For cordless tools	14
• Coated saw blades / sharpening service	16
DRY CUTTER MACHINES	18 - 31
• Chop and miter saws	18
• Circular saws	25
• Pneumatic saws	29
CORE DRILLING TECHNOLOGY	32 - 56
• Magpro core drilling machines	32
• Accessories	47
• Dimensions of the machines	48
• HSS-Co core drill	50
• Coated core drills	54
• Core drill sets	56
JEPSON POWER WEBSITE & SOCIAL MEDIA	57
SPECIAL MACHINES FOR METAL	58 - 67
• Electric Hole Cutting Drill	59
• Electric Tapper	60
• Beveler Deburring Machine	61
• Wraparound Tube Sander/Polisher	64













**DRYTECH® CARBIDE TIPPED
SAW BLADES UNIVERSAL USE ON ALL
CIRCULAR SAWS AND CHOPSAWS**



**SAW BLADES FOR CONSTRUCTION
SITE AND WORKSHOP**

**STANDARD
SAW BLADES**

SPECIAL COATED

	Eco friendly		✓	✓
	Blade diameter	mm	160 - 355	230 - 355
	Cutting capacity	mm	machine-dependent	machine-dependent
	Cutting speed	m	depending on the saw blade diameter	depending on the saw blade diameter
	Cutting width	mm	2,0 - 3,4	2,0 - 2,2
	Centre bore*	mm	25,4	25,4
	Pin bore		customer specific	customer specific
	Teeth		32 - 120	48 - 90
	Resharpenable		✓	✓
	Cordless tools	mm	160 - 180	
	Coated			✓
	Custom sizes on request		✓	✓
	Page number		12	16

* Customer specific bore on request

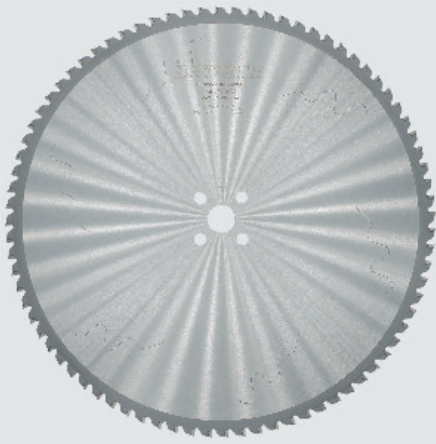

INDUSTRIAL PRODUCTION	LBS - IMPACT RESISTANT	INOX SAW BLADES FOR CORDLESS TOOLS
✓	✓	✓
405 - 630 > on request	137 - 255	137, 150, 165
machine-dependent	machine-dependent	machine-dependent
depending on the saw blade diameter	depending on the saw blade diameter	depending on the saw blade diameter
2,0 - 3,6	1,0 - 1,4	1,5 - 1,7
25,4 - 60	16 - 25,4	20
customer specific	customer specific	customer specific
80 - 210	30 - 66	30 - 42
✓	✓	✓
on request	137 - 180	137,150 ,165
✓	✓	✓
13	14	15



DRY CUTTER MACHINES		PREMIUM SUPER DRY CUTTER 9435 T3	PREMIUM DRY CUTTER 9430 T3	DRY MITER CUTTER 9410 ND	SUPER HAND DRY CUTTER 8320	
#	Reference	600560T3	600520T3	600651	608270	
	Eco friendly	✓	✓	✓	✓	
	Power input	Watt	2.400	2.000	1.500	1.800
	Voltage	230V/50Hz or 115V/60Hz	230V/50Hz	230V/50Hz	230V/50Hz or 115V/60Hz	
	Bore	Ø 25,4	25,4	25,4	25,4	
	No load speed	min ⁻¹	1.400	1.400	1.600	1.700
	Net weight	kg	25	23	19	8,4
	Blade size	mm	355	305	255	320
	Round 90°	mm	Ø 140 / in Inox 125	Ø 115	Ø 70 x 4	120 x 6
	Round 45°	mm	Ø 102	Ø 85	Ø 60 x 4	-
	Square 90°	mm	125 x 125	100 x 100	70 x 70 x 4	120 x 120 x 6
	Square 45°	mm	80 x 80	85 x 85	60 x 60 x 4	-
	Rectangular 90°	mm	105 x 155	85 x 160	100 x 70 x 4	120 x 6
	Rectangular 45°	mm	75 x 100	85 x 85	60 x 60 x 4 (without clamping system)	-
	Angle 90°	mm	125 x 125	100 x 100	70 x 70	120 x 120 x 6
	Angle 45°	mm	80 x 80	85 x 85	60 x 60	-
	Sheet 90°	mm				10
	Sheet 45°	mm				
	Cutting depth 90°	mm				120
	Cutting depth 45°	mm				-
	Miter cut		90 - 75 - 60 - 45°	90 - 75 - 60 - 45°	-45 - 0 - +45°	
	Bevel cut					
	Vibration	m/s ²	1,19	0,53	0,52	1,4
	Vibration damper		✓			
	Sound pressure level	dB(A)	100	100	100	99,0
	Suction				✓	✓
	Cable length	m	2,5	2,5	2,5	5
	Soft Start					✓
	Operating pressure	bar				
	Air consumption	m ³ /min				
	Air connection					
	Page number		19	20	24	25



HAND DRY CUTTER 8230N	HAND DRY CUTTER 8200	HAND DRY CUTTER 8230 AIR	SUPER HAND DRY CUTTER 8320 AIR	PIPE DRY CUTTING MACHINE 180 AIR
608280I	608295	608100	608200	608300Set
✓	✓	✓	✓	✓
1.700	1.700	1.500	1.800	2.400
230V/50Hz or 115V/60Hz	230V/50Hz			
25,4	25,4/20	25,4	25,4	20/30
2.600	3.700	1.700	1.200	1.800
7,1	6,3	8,6	11	12,5
230	203	230	320	160-200
82 x 6 56 x 6	67 x 6 42 x 6	82 x 6 56 x 6	120 x 6 -	300-1600 accessories dependent
82 x 82 x 6 56 x 56 x 4 (bevel cut)	67 x 67 x 6 42 x 42 x 4 (bevel cut)	82 x 82 x 6 56 x 56 x 4 (bevel cut)	120 x 120 x 6 -	
82 x 6 56 x 4 (bevel cut)	67 x 6 42 x 4 (bevel cut)	82 x 6 56 x 4 (bevel cut)	120 x 6 -	
82 x 82 x 6 56 x 56 x 4 (bevel cut)	67 x 67 x 6 42 x 42 x 4 (bevel cut)	82 x 82 x 6 56 x 56 x 4 (bevel cut)	120 x 120 x 6	
10 8 (bevel cut)	10 8 (bevel cut)	10 8 (bevel cut)	10	
82 56 (bevel cut)	67 42 (bevel cut)	82 56 (bevel cut)	120 -	
✓	✓	✓		
1,0	1,0	< 2,5	< 2,5	< 2,5
88,5	88,5	103,3	95	98,0
			✓	
5	5			
✓	✓			
		6	6	6
		2	2	3,0
		R 1/2"	R 1/2"	R 3/3"
26	28	30	29	31



MAGPRO MAGNETIC DRILLING MACHINES MADE BY JEPSON POWER		MAGPRO 35 KOMPAKT	MAGPRO 35	MAGPRO 35 ADJUST 1S MAGPRO 35 ADJUST 2S	MAGPRO 35 SEMI AUTOMATIC	MAGPRO TP 2000	NEW MAGPRO 40/1S ADJUST SWIVEL	
#	Reference	490050	490150	490150 1 490150 2	490180	490190N	490140S	
	Power input	Watt	1.100	1.100	1.100	1.100	1.100	
	Voltage	Hz	230V/50Hz	230V/50Hz	230V/50Hz	230V/50Hz	230V/50Hz	
	Core drill max.Ø x L	mm	12 - 35 x 30	12 - 35 x 70	12 - 35 x 110	12 - 35 x 55	12 - 35 x 110	12 x 40 x 110
	Twist drill max.Ø x L	mm	6 - 11 x 20 Weldon	13 x 110	13 x 140	13 x 110	13 x 110	13 x 140
	Thread cutting max.Ø x L	mm				5 - 22		
	Full drilling empty / load	rpm	650 / 390	620 / 350	450 / 270 730 / 440	620 / 390	550 / 200	450
	Thread cutting No load / Full load	rpm				150 / 90		
	Speed core drilling 1 No load / Full load	rpm	650 / 390	620 / 350	450 / 270	620 / 350	550 / 330	450
	Speed core drilling 2 No load / Full load	rpm			- 730 / 440	P1: 14-20		
	Speed core drilling 3 No load / Full load	rpm				P2: 21-24		
	Speed core drilling 4 No load / Full load	rpm				P3: 25-30		
	R / L rotation					auto reverse tap		
	Stroke	mm	35	80	85 - 230	70	150	85 - 200
	Shank		Weldon 19	Weldon 19	Weldon 19	Weldon 19	Weldon 19	Weldon 19
	Quick Release		✓	optional	✓	optional	✓	
	Magnet holding force	N	15.000	15.000	17.000	15.000	15.000	10.500
	Magnetic surface	mm	165 x 80	165 x 80	175 x 90	165 x 80	165 x 80	158 x 76
	Swivel Base							✓
	Cooling system		external	integrated, automatic	integrated, automatic	integrated, automatic	integrated, automatic	integrated, automatic
	Net weight	kg	10	12	14 15	17	13,7	12
	Operating pressure	bar						
	Air consumption							
	Air connection							
	Page number		35	36	33	37	34	38

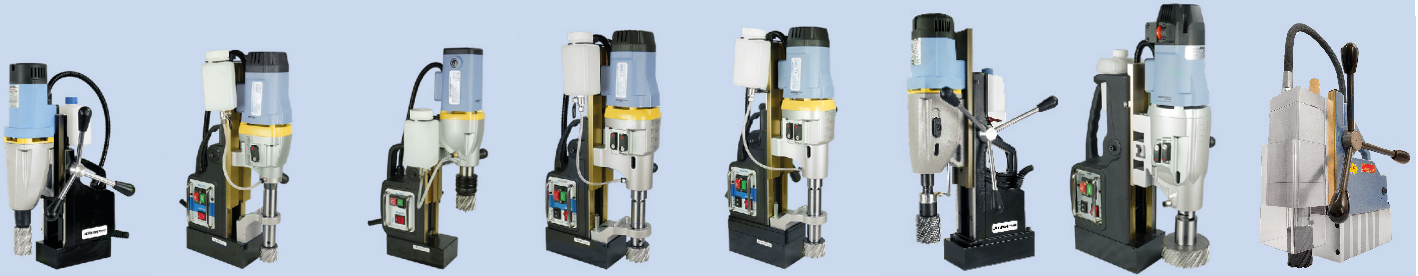

NEW MAGPRO 40/2S	MAGPRO 50/2S	MAGPRO 50/2S ADJUST	MAGPRO 75/4S	MAGPRO 75/4S SWIVEL BASE	NEW MAGPRO 80/4S	MAGPRO 120/4S	MAGPRO 52 AIR
490142	490170	490170 2	490160	490160S	490184	490100	490000
1.100	1.800	1.100	1.800	1.800	1.600	2.000	1.000
230V/50Hz	230V/50Hz	230V/50Hz	230V/50Hz	230V/50Hz	230V/50Hz	230V/50Hz	230V/50Hz
12 x 40 x 110	12 x 50 x 70	12 x 50 x 110	12 - 75 x 70	12 - 75 x 70	12 - 80 x 110	12 - 120 x 70	12 - 52 x 110
13 x 140	16 x 110	13 x 140	16 x 110 / 32 CM3	16 x 110 / 32 CM3	16 x 110 / 32 CM3	16 x 110 / 32 CM3	13 x 140
			3 - 22	3 - 22		3 - 22	
650 / 405 1100 / 790	500 / 300	450 / 170	530 / 310	530 / 310	660 / 365	450 / 140	400 / 200
			210 / 120	210 / 120		120 / 35	
1100 / 790	380 / 230	300 / 180	210 / 120	210 / 120	190 / 105	120 / 35	400 / 200
650 / 405	500 / 300	450 / 170	270 / 160	270 / 160	300 / 165	220 / 70	
			410 / 290	410 / 290	420 / 230	250 / 80	
			530 / 310	530 / 310	660 / 365	450 / 140	
			✓	✓		✓	
165	100	85 - 230	100	100	85 - 270	100	260
Weldon 19	Weldon 19	Weldon 19	Weldon 19/32, CM3	Weldon 19/32, CM3	Weldon 19/32, CM3	Weldon 19/32, CM3	Weldon 19
	optional	✓			optional	✓ (Weldon 19)	
17.000	32.000	17.000	32.000	32.000	17.000	32.000	8.000
175 x 85	200 x 100	175 x 90	200 x 100	200 x 100	220 x 110	200 x 100	216 x 86
				✓			
integrated, automatic	integrated, automatic	integrated, automatic	integrated, automatic	integrated, automatic	integrated, automatic	integrated, automatic	automatic, external
13	22,9	15	24,8	27	24	30	21,5
							6
							1,8
							R 3/8"1
39	40	41	42	43	44	45	46

ECO-FRIENDLY
with Dry Cutting-Technology



Research & development

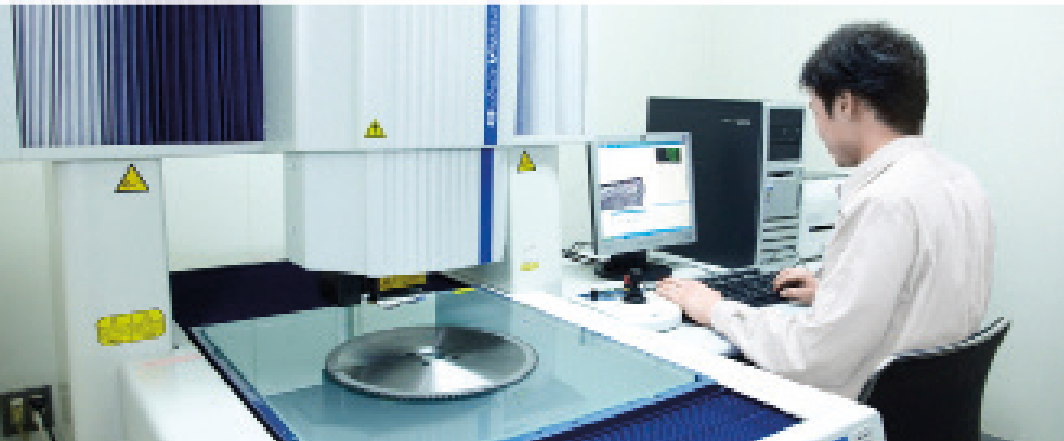

Lasering the segments

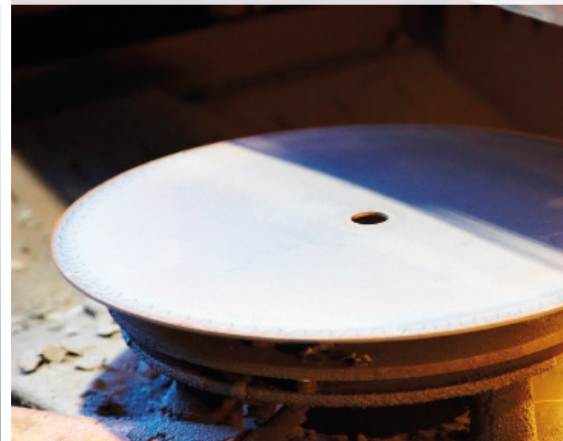

Soldering the carbide teeth

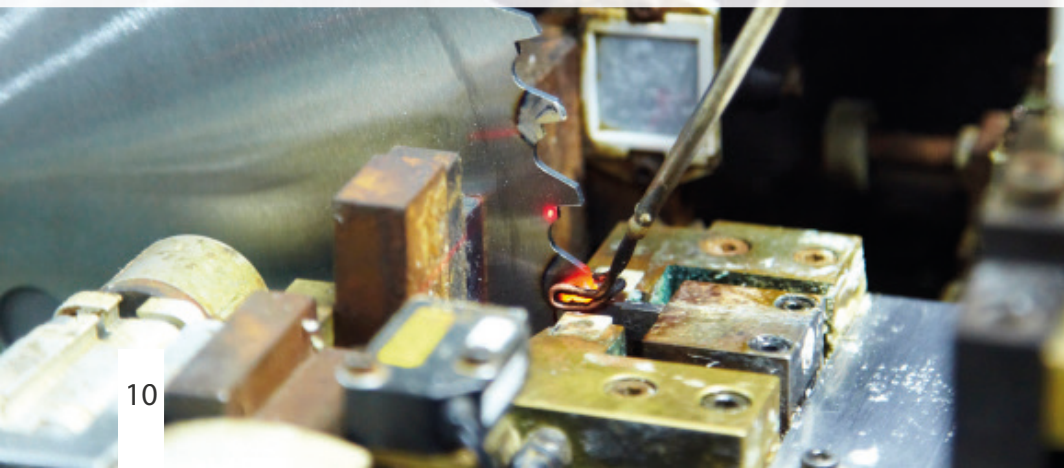

Sharpening process

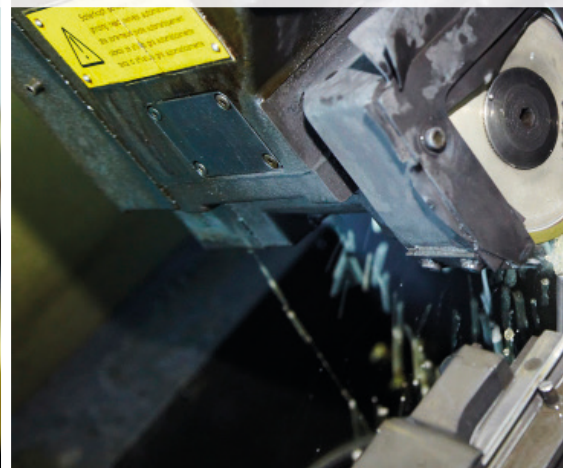

DRYTECH®- METAL CUTTING SAW BLADES

dry - fast - burr free

Carbide or cermet tipped saw blades are suitable for high speed stationary semi-automatic and fully automatic cutting units.

Fast cutting, burr free and without coolant of pipes and profiles made of:
Steel, stainless steel, plastics, compound materials, aluminum and other non-ferrous metals.

The DryTech® saw blades can saw different materials and shapes due to a variety of different geometries: cladding, pipes, sealing profiles, sandwich elements, composites, window profiles and ventilation profiles, etc. The special tooth shape guarantees a perfect cutting surface and a long service life of the saw blades.

- Environmentally friendly thanks to dry cutting technology
- Shortest cycle times thanks to high cutting speed
- Material savings through thin-cutting technology
- with wall thicknesses from 0.5 mm
- Flexible application in different materials and shapes
- Laser slots filled with synthetic resin reduce noise
- Very high durability
- Excellent cut quality
- Can be resharpened up to 5 times

Vibration during the cut:

Jepson Power saw blades 355/90T



Competitor saw blade

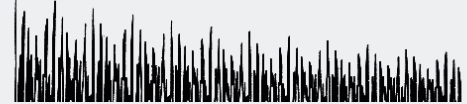

Hardening by heat treatment



Continuous quality control

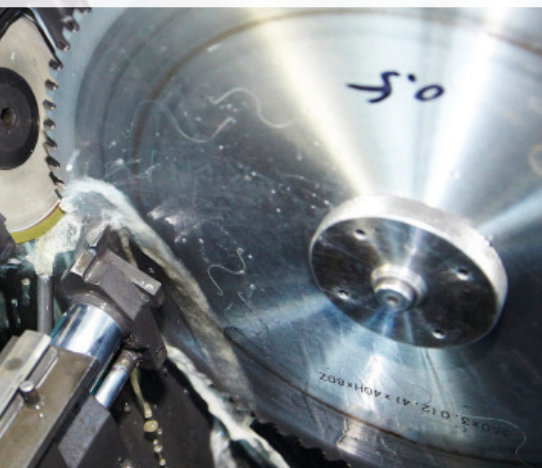



DRYTECH® CARBIDE TIPPED HIGH-SPEED METAL CUTTING SAW BLADES

INDUSTRY & CONSTRUCTION

Ø [mm]	Bore	Kerf	Teeth	Max. rpm	Application	Reference
137	20	1,50	30	4.000	stainless steel	72113730I
150	20	1,50	42	4.000	stainless steel	72115042I
160	30*	1,80	32	4.200	steel	72016032
165	20	1,70	48	4.000	stainless steel	72116548I
180	20	1,85	36	4.000	steel	72118036
180	20	1,60	48	4.000	steel	72118048S
180	20	2,00	48	4.000	steel & stainless steel	72118048YS
192	20	1,85	40	4.000	steel	719240
192	20	1,85	48	4.000	steel (thin)	719248
192	20	1,85	48	4.000	aluminium	719248A
192	20	1,85	70	4.000	metal sheets	719270
200	30*	1,90	40	3.800	steel	72020040
200	30*	1,90	60	3.800	steel (thin)	72020060
203	25,4	1,90	42	3.800	stainless steel	72120342I
203	25,4	1,90	48	3.800	aluminium	72120048A
203	25,4	1,90	70	3.800	steel (thin wall)	72120070
210	30*	2,00	42	3.600	steel	72021042
210	30*	2,00	64	3.600	steel (thin wall)	72021064
230	30*	2,00	48	3.000	steel	72023048
230	30*	2,00	60	3.000	aluminium	72023060
230	30*	2,00	68	3.000	steel (thin)	72023068
230	25,4	2,00	48	3.000	steel	72123048
230	25,4	2,00	48	3.000	steel & stainless steel	72123048I
230	25,4	2,00	60	3.000	aluminium	72123060
230	25,4	2,00	68	3.000	steel (thin)	72123068
230	25,4	2,00	84	3.000	metal sheets	72123084
255	25,4	2,00	60	2.200	steel	600598
255	25,4	2,00	66	2.200	steel (thin)	600654
255	25,4	2,00	80	2.200	aluminium	600655A
305	25,4	2,00	60	1.800	steel	600530
305	25,4	2,00	60	1.800	steel & stainless steel	600530 40
305	25,4	2,00	60	1.800	cast iron	600535
305	25,4	2,00	80	1.800	steel (thin)	600540
320	25,4	2,00	84	1.800	steel	608276
320	25,4	2,00	72	1.800	steel (thick)	608278
355	25,4	2,00	120	1.800	stainless- & steel (thin)	600512I
355	25,4	2,00	90	1.800	steel & stainless steel	600570
355	25,4	2,00	72	1.800	steel & stainless steel	600580
355	25,4	2,00	60	1.800	steel & stainless steel	600590
355	25,4	2,00	60	1.800	cast iron	600591
355	25,4	2,00	66	1.800	steel	600595
355	25,4	2,00	96	3.500	aluminium	600594

ECO-Friendly



Our dry cutting technology eliminates the need for lubricants. Sawing with our saw blades is therefore particularly environmentally friendly.

Our carbide-tipped saw blades saw quickly, burr free and **without cooling**:

- Steel
- Non-ferrous metals
- Plastic
- Composites
- Stainless steel

Universally applicable on hand-held circular saws, miter saws and stationary machines.

- Very high durability
- Excellent cutting quality
- Short cutting times
- Thin-walled
- Noise reduced thanks to laser slots filled with synthetic resin
- Can be resharpened up to 5 times



Technical data

Saw blade diameter	137-355 mm
Max. rotational speed	1.800 - 4.200 rpm
Cutting width	1,50-2,20 mm
Pin holes	Customized

* Reducing rings included (30/25, 30/20, 30/16)

FOR INDUSTRIAL USE



DRYTECH® carbide or cermet tipped saw blades are suitable for high speed stationary semi-automatic and fully automatic cutting units.

Fast cutting, burr free and without coolant of pipes and profiles made of:

- steel
- stainless steel
- plastics
- compound materials
- other non-ferrrous metals

- Shortest cycle times due to high cutting speed
- Material saving through thin cut technology with wall thickness starting from 0,01" / 0.5 mm
- Very high durability
- Excellent cutting quality
- Up to 5 times resharpenable
- Low set-up costs
- Cost-effective

Ø [mm]	Bore [mm]	Cutting width [mm]	Teeth	Reference
405	25,4	2,5	80	4050800002
405	25,4	/2,5	102	4051021003
455	50,0	3,4	100	4551000002
455	50,0	3,4	120	4551201003
560	50,0	3,4	120	5601200002
560	50,0	3,4	132	5601321003
560	50,0	3,4	180	5601801004
630	60,0	4,0	140	6301400002
630	60,0	4,0	150	6301501003
630	60,0	3,6	210	6302100003

*** Special sizes on request**

Technical data	
Saw blade diameter	405-630 mm
Cutting capacity	6-240 mm
Max. rotational speed	1.800 m/min
Max. saw blade feed	6.000 mm/min
Cutting width	2,5-4,0 mm
Centre bore	Customized
Pin bore	Customized



LBS IMPACT RESISTENT SAW BLADES FOR METAL

Ideal for cutting metal grids and grates, trapezoidal sheets, metal profiles, conduits, shutter pipes and much more. With 1.0 to 1.5 mm LBS-blades are much thinner than conventional saw blades. Therefore sawing with LBS-saw blades saves material and time.



Ø [mm]	Kerf	Blade body width	Bore	Teeth	Max. no load speed	Reference	For machine
137	1,0	0,8	20	30	4500 rpm	72213730	Bosch, Milwaukee, Makita etc.
150	1,2	0,94	20	34	4500 rpm	72215034	Makita, Milwaukee etc.
165	1,2	0,94	20	40	4200 rpm	72216540	Metabo, Milwaukee, Hikoki, Hilti
180	1,2	0,94	20	48	4000 rpm	72218048	Flex, Hitachi, Makita, Rexon, Hilti etc.
184	1,2	0,94	16	48	4000 rpm	72218448	Bosch, Dewalt, Makita, Milwaukee
192	1,2	0,94	20	48	4000 rpm	72219248	Jepson Power HDC 8219
203	1,2	0,94	25,4/30	48	3800 rpm	72220348	AEG, Bosch, Jepson Power etc.
230	1,4	1,2	25,4	60	3000 rpm	72223060	Jepson Power HDC 8230N
255	1,5	1,2	25,4	66	2200 rpm	72225566	Jepson Power DMC 9410ND

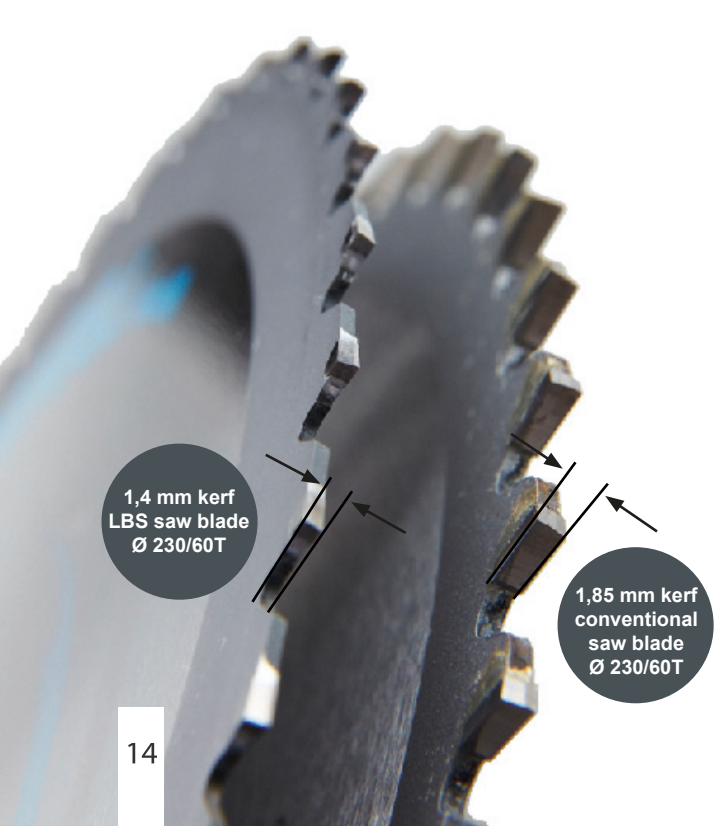



CARBIDE TIPPED SAW BLADES FOR STAINLESS STEEL IDEAL FOR CORDLESS TOOLS



Advantages

- Clean cut
- Less flying sparks
- Very high durability
- No tarnishing of the material
- Low friction
- Material-saving, efficient and fast
- Environmentally friendly, without coolant
- Longer battery performance through innovative teeth

Ø [mm]	Kerf	Blade body width	Bore	Teeth	Max. no load speed	Reference	For machine
137	1,5	1,3	20	30	4000 min ⁻¹	721137301	Bosch, Milwaukee, Makita etc.
150	1,5	1,3	20	42	4000 min ⁻¹	721150421	Makita, Milwaukee etc.
165	1,7	1,4	20	48	4000 min ⁻¹	721165481	Metabo, Milwaukee, Hikoki, Hilti



The brand names used by the respective companies are subject to general trademark, trademark or patent protection.

Universal use also on all conventional cordless tools!

Max RPM is printed on sawblades!

NSF-SPECIAL COATED SAW BLADES FOR STAINLESS STEEL



The coating of NSF-saw blade

The NSF saw blades are processed with an aluminum-titanium-chromium nitride layer, so that they are also ideally suited for special applications when machining materials that tend to stick together. The silver-colored layer is characterized by high hardness and resistance to oxidation. In addition, the NSF saw blade is designed to minimize the tendency to adhesion when processing stainless steel.

The NSF saw blades are suitable for stainless steels in the food and construction sectors.

Advantages of coated saw blades

- Cutting of stainless steel
- Up to 3 times higher durability
- No tarnishing of materials
- Lower friction
- Lower cost than standard saw blades
- resharpenable up to 5 times

Technical data

Material	Aluminium titanium chromium nitride, AlTiCrN (Stacked)
Microhardness HV 0,05	3.000 +/- 30
Coefficient of friction against steel 100Cr6	0,4
Maximale operating temperature	800° C / 1.470°F
Thickness	2 - 4 µm

Coated saw blades range (special dimensions on request)

Ø [mm]	Bore	Kerf	Teeth	Reference	Use
230	25,4	2,00	48	72123048NSF	Food and construction
255	25,4	2,00	66	600654NSF	Food and construction
320	25,4	2,20	84	608275NSF	Food and construction
355	25,4*	2,20	90	600570NSF	Food and construction

* with pin bore (4/11/TK 55 mm)



COATING SYSTEM FOR OUR NSF SAW BLADES



RESHARPENING CENTER

Resharpener of carbide tipped
saw blades
We offer resharpener and replacement
of carbide teeth.
Please send the saw blades to be
resharpened to the following address:

Jepson Power GmbH
Ernst-Abbe-Straße 5
52249 Eschweiler, Germany



ECO-FRIENDLY
with Dry Cutting-Technology





PREMIUM SUPER DRY CUTTER 9435

THE BESTSELLER

Metal cutting chop saw by Jepson Powerr for fast and burr free cutting of metal pipes and profiles without coolant

- Cuts ferrous and non-ferrous metal tubes, pipes and profiles made of mild steel, stainless steel, aluminum, plastic and composite materials
- No need for lubricant and manual deburring
- Exclusive blade stabilising system reduces vibration
- High torque motor for continuous operation
- Patented quick-release vice for bevel cuts
- Heavy duty angle cutting at 90-75-60-45°
- Fitted with a Ø 355/90T carbide tipped saw blade
- Optional stand for a comfortable and save work place
- CE approved operating system

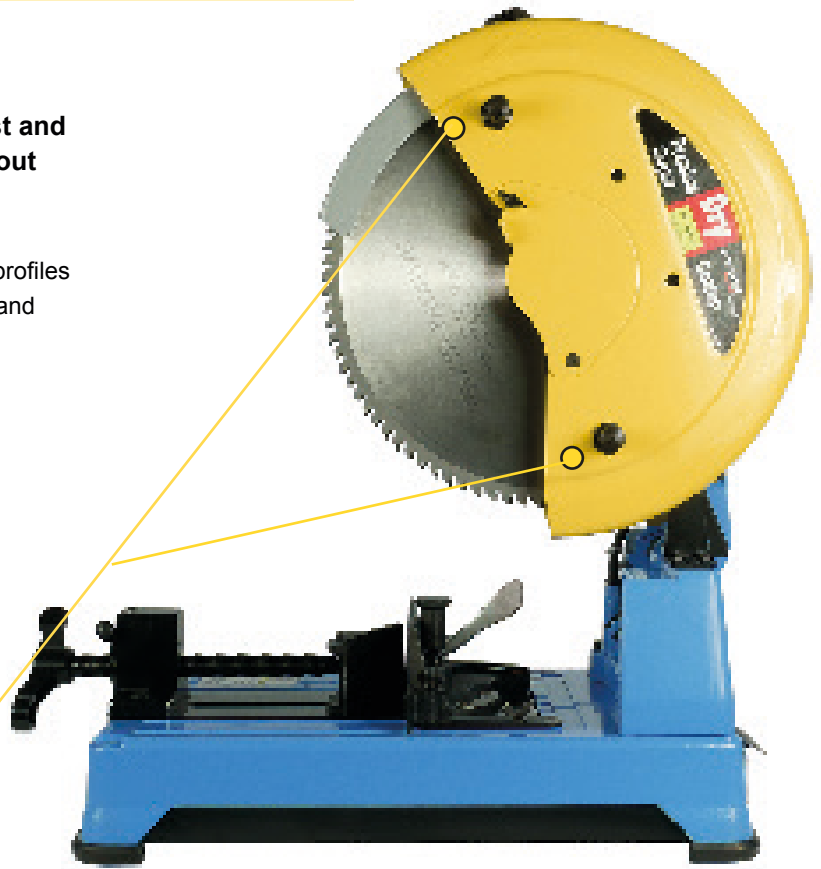

TWO PATENTED STABILIZERS FOR A BETTER CUTTING SURFACE AND LONG CUTTING LIFE



„K“ CLAMPING SET FOR SQUARE TUBES
For a safer and more stable sawing process (included)

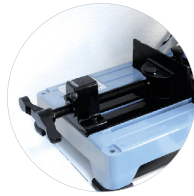

QUICK RELEASE QUICK RELEASE SYSTEM
Enables precise and efficient clamping



RIP FENCE
Increased stability - makes it easier to saw short materials



MITER CUTS CAN BE ADJUSTED WITHOUT TOOLS
90-75-60-45°

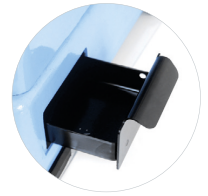

CHIP COLLECTOR
For a clean workplace

Power input	Voltage	No load speed	Net weight	Blade size	Bore
2.400 W	230V/50Hz or 115V/60Hz	1.400 min ⁻¹	25 kg	Ø 355 mm	Ø 25,4

Premium Super Dry Cutter 9435	Reference
with 355/90T saw blade 230V	600560T3
with 355/90T saw blade 115V	600560UST3

Accessories page 21	Reference
Stand for PSDC 9435	600526T3
Eccentric clamping system	609910
Thinfix - Clamping system for open profiles	600546

Max. cutting capacities		
	90°	45°
Round	140 / Inox 125	102
Square	125 x 125	80 x 80
Rectangular	105 x 155	75 x 100

Saw blades	Reference
Ø 355/90T for steel and stainless steel - coated food and construction	600570NSF
Ø 355/120T steel and stainless steel - extra thin	600512I
Ø 355/90T steel and stainless steel - thin	600570
Ø 355/72T steel and stainless steel - medium	600580
Ø 355/60T steel and stainless steel - thick	600590
Ø 355/60T - cast iron	600591
Ø 355/66T - mild steel	600595
Ø 355/96T - aluminum	600594



PREMIUM DRY CUTTER 9430

THE ORIGINAL

The perfect sawing machine
for construction site and workshop

- Cuts ferrous and non-ferrous metal tubes, pipes and profiles made of mild steel, aluminum, plastic and composite materials
- No need for lubricant and manual deburring
- High torque motor for continuous operation
- Gear box for easy blade changes
- Patented quick-release vice for bevel cuts
- Heavy duty angle cutting at 90-75-60-45°
- Fitted with a Ø 305/60T carbide tipped saw blade
- Optional stand for a comfortable and save work place
- CE approved operating system

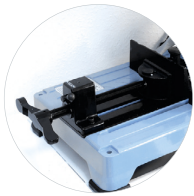

QUICK RELEASE SYSTEM
Enables precise and efficient clamping

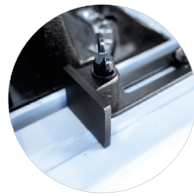

RIP FENCE
Increased stability - makes it easier to saw short materials



MITER CUTS CAN BE ADJUSTED WITHOUT TOOLS
90-75-60-45°

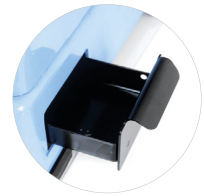

CHIP COLLECTOR
For a clean workplace

Power input	Voltage	No speed load	Net weight	Blade size	Bore
2.200 W	230V/50Hz	1.400 min ⁻¹	23 kg	Ø 305 mm	Ø 25,4

Premium Dry Cutter 9430	Reference
with 305/60T saw blade 230V	600520T3

Max. cutting capacities		
	90°	45°
Round	115	85
Square	100 x 100	85 x 85
Rectangular	85 x 160	85 x 85

Saw blades	Reference
305/60T for steel, non-ferrous metals and composites	600530
305/60T for steel & stainless steel	600530 40
305/60T cast iron	600535
305/80T for thin tubes and profiles	600540

Accessories page 21	Reference
Stand for PSDC 9435	600526T3
Eccentric clamping system	609910
Thinfix - Clamping system for open profiles	600546

ACCESSORIES FOR PSDC 9435

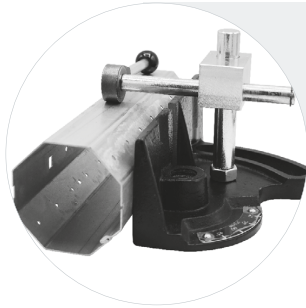

ECCENTRIC CLAMPING SYSTEM

For thin-walled profiles
Reference 609910

Simplifies the clamping of thin-walled profiles. Since the clamping pressure is exerted by two separate systems, deformation of the workpiece is not possible.

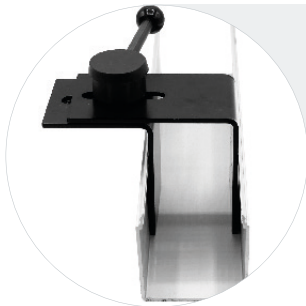
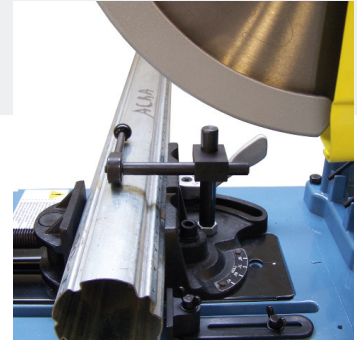

THINFIX CLAMPING SYSTEM

For open profiles
Reference 600546

Prevents the material from vibrating during clamping. The result is an improvement in the cutting surface and an extension of the cutting life.

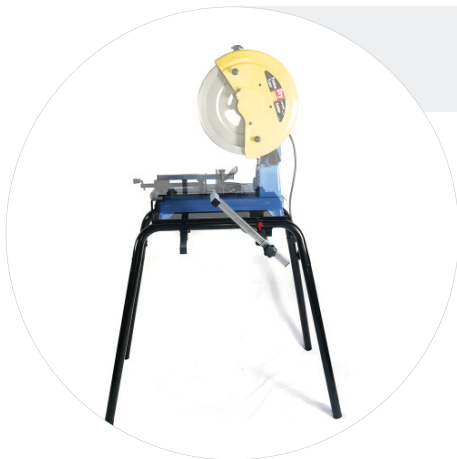
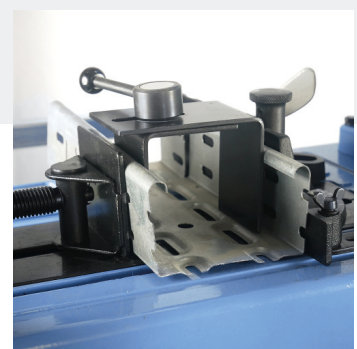

STAND FOR PSDC 9435

Reference 600526T3

Assembly stand with length stop for comfortable and safe working. Adjustable material support, stop with integrated scale, adjustable feet to compensate for irregularities on the floor.

HEIGHT-ADJUSTABLE SUPPORT



LENGTH STOP
WITH INTEGRATED SCALE
0 - 355 MM

ADJUSTABLE HEIGHT



PRODUCTION UNIT

FOR SMALL SERIES PRODUCTION AT 90 ° :

- 3 meter feed roller and measuring track for plastic, aluminum and steel profiles
- 3 meter discharge roller and measuring track for plastic, aluminum and steel profiles
- Track width 390 mm, conveyor roller width 300 mm
- Support roller pitch ~ 290 mm
- Load capacity per meter of roller conveyor ~ 100 kg
- Track height adjustable from 760 - 1,100 mm

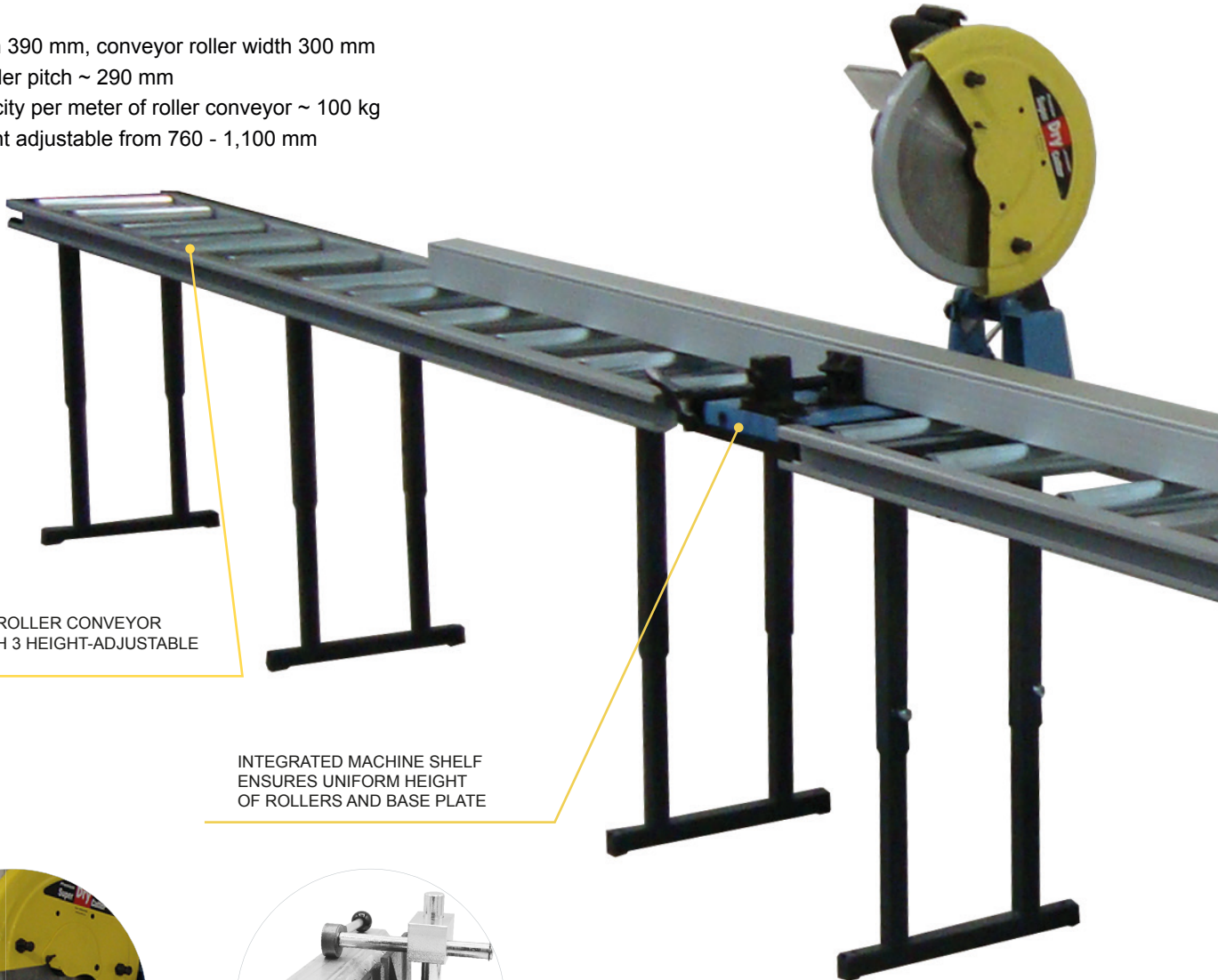

MATERIAL FEED ROLLER CONVEYOR
LENGTH 3 M WITH 3 HEIGHT-ADJUSTABLE
SUPPORTS

INTEGRATED MACHINE SHELF
ENSURES UNIFORM HEIGHT
OF ROLLERS AND BASE PLATE

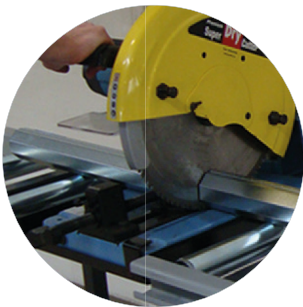

Premium Super Dry Cutter 9435
and saw blade in action

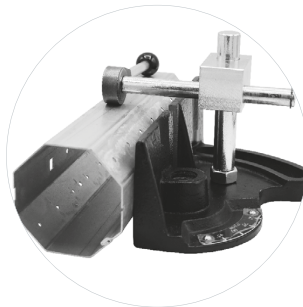

Ideal for sawing roller shutter tubes with the
eccentric clamping system
Ref. 609910

Description	Reference
Production unit - analog incl. material supply and discharge track 3m *and Premium Super Drycutter 9435 & saw blade 90T	609960 A
Production unit - digital incl. material supply and discharge track 3m * and Premium Super Dry Cutter 9435 & saw blade 90T	609960 B
Additional material feed and discharge track 3m *	609960
Quick clamping system for series cuts with the same diameter or size	1501128
Eccentric clamping system	609910
Thinfix - Clamping system for open profiles	600546
Special sizes	*on demand

Saw blades	Reference
355 / 90T for stainless steel - coated Food & Construction	600570NSF
355 / 120T for very thin steel and stainless steel	6005121
355 / 90T for thin steel and stainless steel	600570
355 / 72T for medium steel and stainless steel	600580
355 / 60T for thick steel and stainless steel	600590
355 / 60T for cast iron	600591
355 / 66T for unalloyed steel	600595
355 / 96T for aluminum	600594

OPTIONAL

Vice with quick release system for series cuts with constant diameter or size

Reference 1501128

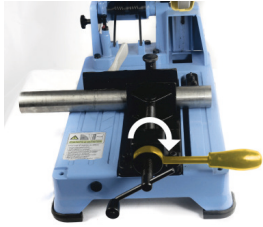

1. Starting position:
The quick release lever is on the right.

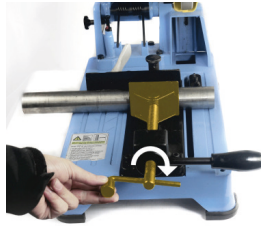

2. The material to be sawn is fixed with the spindle (one-time process).



3. After the cut, the quick release lever is placed on the left side.



4. The next workpiece is brought into the position to be sawed.

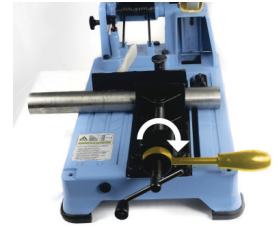

5. Turn the lever to the right and start the sawing process:
next steps: 3 - 4 - 5.

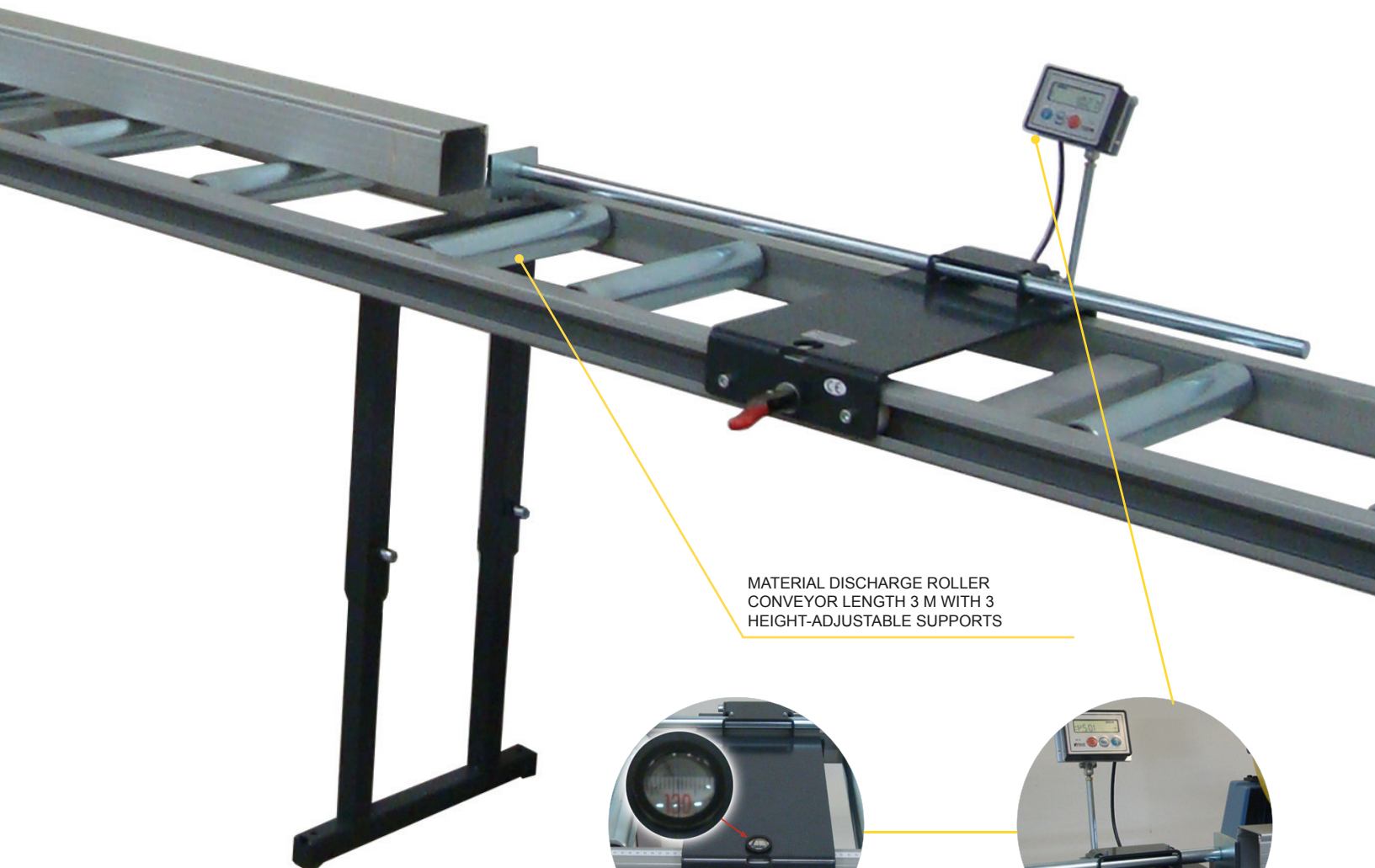

MATERIAL DISCHARGE ROLLER
CONVEYOR LENGTH 3 M WITH 3
HEIGHT-ADJUSTABLE SUPPORTS

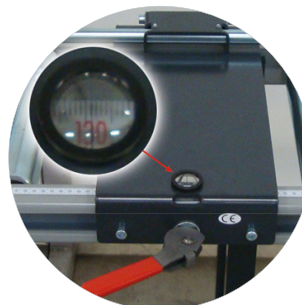

Variant A: ANALOG,
with analog measuring range display
Art. 609960 A

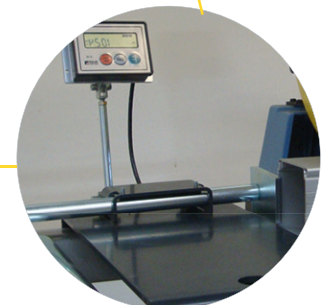

Variant B: DIGITAL,
with digital measuring range display
Art. 609960 B



DRY MITER CUTTER 9410 ND

THE VERSATILE

The perfect sawing machine for construction site and workshop

- The precise miter saw for metal: Ideal for cutting tubes & profiles made of stainless steel, steel, non ferrous metal, plastic and composite materials
- The solution for dry wall construction!
- Fine cuts in soft and sensitive materials
- No need for lubricant and manual deburring
- Infinitely adjustable miter cut of -45° - 0° - $+45^{\circ}$
- Secure fixing with double 3-step quick release system
- Fitted with a \varnothing 255/60T carbide tipped saw blade
- Robust aluminum construction, strong and light: only 19 kg



DOUBLE QUICK RELEASE SYSTEM

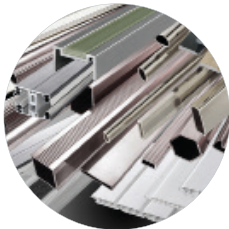

Saws stainless steel, steel, non-ferrous, metals & composites
Ideally suited for professional work in the field of: interior, exterior, kitchen construction, heating, air conditioning, sanitary etc.

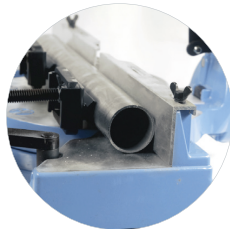

Incl. Fixing set „K“ for pipes
Ref. 600653



Optional stand
Ref. 600599

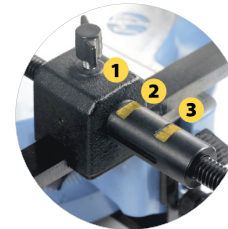

3-stage quick release system

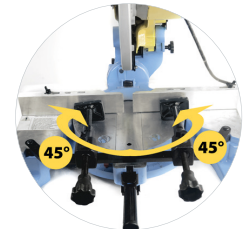

Stepless miter adjustment

Power input	Voltage	No load speed	Net weight	Blade size	Bore
1.500 W	230V/50Hz or 115V/60HZ	1.600 min ⁻¹	19 kg	\varnothing 255	25,4

Dry Miter Cutter 9410 ND	Reference
with 255/60T saw blade and fixation set „K“ for tubes \varnothing 30 up to 70 mm 230V	600651
with 255/60T saw blade and fixation set „K“ for tubes \varnothing 30 up to 70 mm 115V	600651US

Saw blade	Reference
\varnothing 255/66T steel and stainless steel - coated food and construction	600654NSF
\varnothing 255/60T - mild steel	600598
\varnothing 255/66T - thin steel	600654
\varnothing 255/80T - aluminum	600655A
\varnothing 255/66T - LBS metal grids	72225566

Accessories	Reference
Stand for DMC 9410ND	600599
Fixation set „K“ for tubes \varnothing 30 mm up to 70 mm	600653

Max. cutting capacities	90°	45°
	Round	70 x 4 mm
Square	70 x 70 x 4 mm	60 x 60 x 4 mm
Rectangular	100 x 70 x 4 mm	60 x 60 x 4 mm



SUPER HAND DRY CUTTER 8320

THE BIGGEST



Metal cutting circular saw by Jepson Power for fast and low-burr sawing of sandwich panels and trapezoidal sheets without cooling

- Ideal for cutting sandwich panels, trapezoidal sheet, trunking and cable ducting, steel pipes and nonferrous metals, composite materials etc., up to a cutting depth of 120 mm on guide rail
- Dry cutting without lubricant
- Closed construction of the blade guard prevents flying chips to the user
- Integrated chip collector, connector for optional extraction device
- LED overload indicator: green: ok. flashing red: warning | red: over load
- Lightweight magnesium: 8,4 kg (without saw blade)
- Ideal for clean and straight cutting of sandwich panels
- Optional: Guide rail 1.400 mm delivered with 2 C-clamps
- incl. Ø 320 mm / 84T carbide tipped saw blade

CONNECTION FOR VACUUM CLEANER

CHIP COLLECTOR



Optional:
Transport case with wheels



Examples of cuts

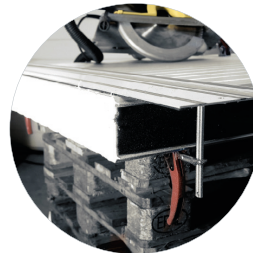

Quick fixation

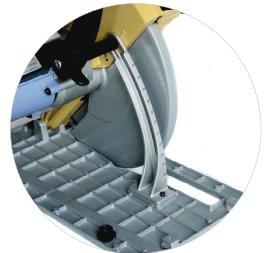

Depth adjustment with scaling

Power input	Voltage	No load speed	Net weight	Blade size	Bore	Cable length
1.800 W	230V/50Hz or 115V/60HZ	1.700 min ⁻¹	8,4 kg	Ø 320 mm	Ø 25,4	5 m

Super Hand Dry Cutter 8320	Reference
with Ø 320/84T saw blade 230V	608270
with Ø 320/84T saw blade 115V	608270 U
Saw blades	Reference
320/84T for sandwich panels and steel	608276
320/72T for thick walled material	608278
Ø 320/84T steel and stainless steel - coated food and construction	608276NSF

Accessories	Reference
Guide rail 1.400 mm	608275D
Guide rail set 1.400 mm incl. 2 quick release clamps	608275SET
Heavy duty professional blow carry case	60827Box
Connector for guide rail	608275B
Quick release clamp for guide rail (2 pcs.)	608275S

Max. cutting capacities	90°
Round	120 x 6 mm
Square	120 x 120 x 6 mm
Rectangular	120 x 120 x 6 mm



HAND DRY CUTTER 8230N

THE AGILE

- Ideal for cutting sheet metal, sandwich panels, pipes and steel profiles, non-ferrous materials and composites
- By default fitted with a Ø 230 mm/48T resharpenable saw blade for highest cutting lives and a high cutting quality
- Optionally with an impact-resistant LBS saw blade especially designed for gratings
- Strong and light construction, only 7,1 kg
- Chip collector for clean work
- No need for lubrication
- Maximum cutting depth 82/56 mm bevel cut and thickness 10 mm



CHIP COLLECTOR



Ideal for cutting metal grids with LBS saw blade impact-resistant
Ref. 608280LBS



Saws sheet metal up to 10 mm and sandwich panels and profiles with a cutting depth of up to 82 mm

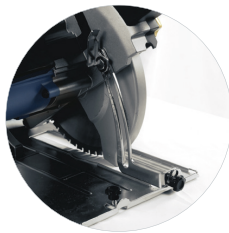

Depth adjustment with scaling

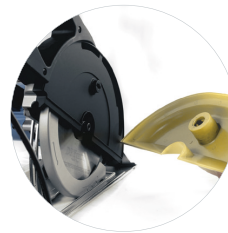

Chip collector



45° bevel cut

Power input	Voltage	No load speed	Net weight	Blade size	Bore	Cable length
1.700 W	230V / 60Hz or 115V / 60Hz	2.600 min ⁻¹	7,1 kg	Ø 230 mm	Ø 25,4	5 m

Hand Dry Cutter 8230N + carry case	Reference
with Ø 230 / 48T Inox saw blade 230V	608280I
with Ø 230 / 48T Inox saw blade 115V	608280iUS
with Ø 230 / 48T Inox saw blade 230V + adjustable guide rail integrated clamping system only 90° cut	608280ICG
with Ø 230 / 60T LBS saw blade impact-resistant 230V	608280LBS

Saw blades	Reference
Ø 230/48T	72123048
Ø 230/48T steel and stainless steel	72123048I
Ø 230/48T steel and stainless steel - coated food and construction	72123048NSF
Ø 230/60T - aluminum	72123060
Ø 230/68T- thin walled material	72123068
Ø 230/84T - thin sheets	72123084
Ø 230/60T - LBS metal grids	72223060

Max. cutting capacities	90°	45° (bevel cut)
	Round	82 x 6 mm
Square	82 x 82 x 6 mm	56 x 56 x 4 mm
Angle	82 x 82 x 6 mm	56 x 56 x 4 mm
Plane	10 mm	8 mm
Cutting depth	82 mm	56 mm

Accessories	Reference
Cutting guide rail with integrated clamping system (600 - 1200 mm)	608284



ADJUSTABLE GUIDE RAIL WITH INTEGRATED CLAMPING SYSTEM

Adjustable guide rail: Ideal for the clean and straight cutting to length of trapezoidal sheets, metal grids, sandwich panels, multiple metal profiles and tubes and many other materials.

- Quick and easy setting of the desired clamping range (600 - 1.200 mm)
- Tool-free fixation of the materials to be sawn
- Safe and tilt-free guidance of the saw blade through the material

The Hand Dry Cutter 8230N achieves the best results with the impact-resistant LBS saw blade (cutting width only 1.4 mm). Cutting depth: 80 mm with rail - 82 mm without rail. Bevel cut only without rail.



Materials



Ideal for cutting metal grids with LBS saw blade

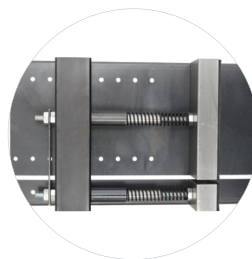

Tool-free fixation



Clamping example

Description

Adjustable guide rail with integrated clamping system for Hand Dry Cutter 8230N

Reference

608284

HDC 8230N - 230V in a case
+ Ø 230 / 48T stainless steel saw blade
+ Guide rail with adjustable clamping range

608280ICG



HAND DRY CUTTER 8200

THE COMPACT

Metal cutting circular saw by Jepson Power for fast and burr-free sawing of metal pipes and profiles without coolin

Ideal for sawing steel, sheet steel, sandwich panels, metal plates, pipes and profiles made of steel, non-ferrous materials and composites (optionally with impact-resistant LBS saw blade)

- Equipped as standard with a resharpenable Ø 203 / 42T carbide tipped saw blade for steel and stainless steel
- Solid and light: only 6.3 kg
- Chip collecting container for clean work
- Lubricant unnecessary
- Max. cutting depth of 67/42 mm bevel cut, up to a thickness of 10 mm



CHIP COLLECTOR



Ideal for cutting metal grids with LBS saw blade, impact-resistant
Ref.: 608295LBS

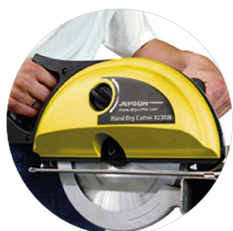

Saws sheet metal up to 10 mm and sandwich panels and profiles with a cutting depth of up to 67 mm

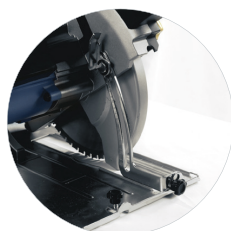

Depth adjustment with scaling

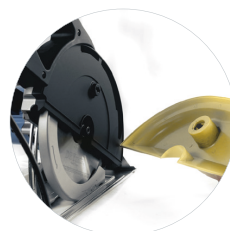

Chip Collector



45° Shiftlercut

Power input	Voltage	No load speed	Net weight	Blade size	Bore	Cable length
1.700 W	230V / 50Hz	3.700 min ⁻¹	6,3 kg	Ø 203 mm	Ø 25,4/20	5 m

Hand Dry Cutter 8200 230V	Reference
with 203 / 42T for steel + stainless steel (Inox)	608295
with 203 / 48T LBS saw blade impact-resistant	608295LBS

Saw blades	Reference
203 / 42T for steel + stainless steel	72120342I
200 / 48T for aluminum	72120048A
203 / 48T LBS - shock resistant	72220348
200 / 70T for thin-walled material / corrugated sheets	72120070

Max. cutting capacities	90°	45° (bevel cut)
	Round	67 x 6
Square	67 x 67 x 6	42 x 42 x 4
Angle	67 x 6	42 x 4
Plan	10	8
Cutting depth	67	42



SUPER HAND DRY CUTTER 8320 AIR

AIR OPERATED

MADE
IN
GERMANY

Dry Cutter - The optimal portable machines for construction sites and workshops

- Ideal for sawing sandwich panels, trapezoidal sheets, cable ducts, steel pipes, ferrous and non-ferrous metals, composite materials, etc. up to a cutting depth of 120 mm on guide rails.
- Closed construction prevents chips from flying to the user
- Integrated chip tipping compartment, connection for optional suction device
- Magnesium lightweight construction: 11 kg (without saw blade) delivered in a case
- Incl. Ø 320 mm / 84T carbide tipped saw blades



CONNECTION FOR VACUUM CLEANER

CHIP COLLECTOR

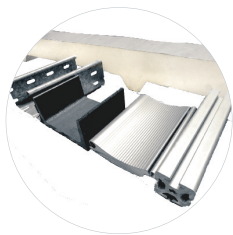

Examples of cuts



Quick fixation



SHDC with guide rail set



Incl. Professional case with wheels



Depth adjustment with scaling

Technical specifications

Operating pressure (flow pressure)	6 bar
Motor output	1.800 W
No load speed	1.200 min ⁻¹
Bore	Ø 25,4
Air consumption	≈ 2 m ³ / min
Air connection	R ½"
ID of hose	min. Ø 16 mm
Net weight	11 kg
Blade size	320 mm
Noise level (1 m distance)	95 dB (A)
Vibration level no load speed	< 2,5 m/s ²

Super Hand Dry Cutter 8320 Air + carry case

with Ø 320/84T saw blades **Reference** 608200

Saw blades

Ø 320/84T - standard	Reference 608276
Ø 320/84T for stainless steel food & construction	608276NSF
Ø 320/72T for thick walled steel	608278

Accessories

Cutting guide rail 1.400 mm + 2 C-clamps	Reference 608275SET
Cutting guide rail 1.400 mm	608275D
Connector for cutting guide rail	608275B
Heavy duty professional blow case	60827BOX
C-Clamp for cutting guide rail (single)	608275S

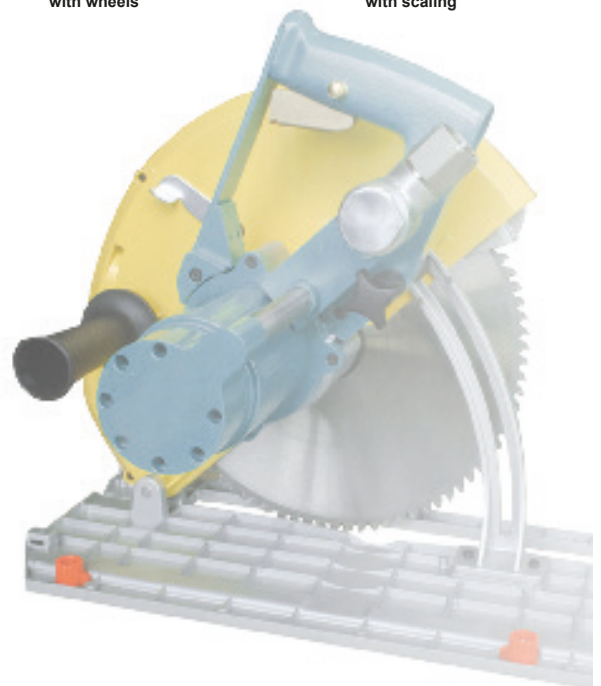

Max. cutting capacities on guide rail

	90°
Round	120 x 6
Square	120 x 120 x 6
Rectangular	120 x 6

HAND DRY CUTTER 8230 AIR

AIR OPERATED

MADE
IN
GERMANY



Metal cutting circular saw by Jepson Power for fast and low-burr sawing of metal pipes and profiles without cooling

- Ideal for sawing sheet metal, sandwich panels, metal plates, tubes and profiles made of steel, non-ferrous materials and composites, optionally with impact-resistant LBS saw blade
- Equipped as standard with a resharpenable Ø 230 / 48T carbide tipped saw blade for exact cuts with long service life
- Solid and light, only 8.6 kg
- Chip collecting container for clean work
- Lubricant unnecessary
- Maximum cutting depth of 82 mm / 56 mm bevel cut up to a thickness of 10 mm



CHIP COLLECTOR



Ideal for cutting metal grids with LBS saw blade
Art.: 608100LBS



Saws sheet metal up to 10 mm and sandwich panels and profiles with a cutting depth of up to 82 mm

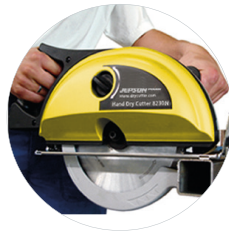

With a cutting depth of up to 82 mm

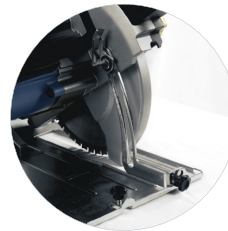

Depth adjustment with scaling

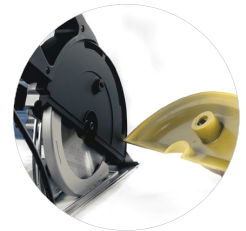

Chip collector

Hand Dry Cutter 8230 AIR Reference

with Ø 230/48T standard saw blade + carry case	608100
with Ø 230/60T LBS saw blade + carry case	608100LBS

Technical specifications

Operating pressure (flow pressure)	6 bar
Bore	Ø 25,4
Motor output	1.500
No speed load	1.700 min ⁻¹
Air consumption	circa 2 m ³ / min
Air connection	R ½"
ID of hose	mind. Ø 13 mm
Net weight	8,6 kg
Blade size	230 mm
Noise level (1 m distance)	103,3 dB (A)
Vibration level no load speed	< 2,5 m/s ²

Accessories Reference

Adjustable guide rail with integrated clamping system for Hand Dry Cutter 8230N	608284
---	--------

Saw blades Reference

230 / 48T standard for steel	72123048
230 / 48T for stainless steel / steel	72123048I
230 / 48T for stainless steel food & construction coated	72123048NSF
230 / 60T for aluminum	72123060
230 / 68T for thin-walled material	72123068
230 / 84T for thin sheet metal	72123084
230 / 60T LBS impact-resistant	72223060

Max. cutting capacities

	90°	45° (bevel cut)
Round	82 x 6	56 x 4
Square	82 x 82 x 6	56 x 56 x 4
Angle	82 x 6	56 x 4
Plan	10	8
Cutting depth	82	56

PIPE DRY CUTTING MACHINE

180 AIR

MADE
IN
GERMANY



- Pneumatic drive unit
- Adjustable cutting depth
- Cutting capacities: Ø 300 to 1600 mm (to be specified before the assembly)
- Air connection with sensor block
- Protective hood
- Including carbide tipped saw blade Ø 180 mm / 48T
- Selection of saw blades for different types of application

Pipe Dry Cutting Machine 180 Air	Reference
with accessories for pipes up to Ø 300 mm	608300
Saw blades	Reference
Ø 180/48T saw blade	72118048S
Ø 180/48T for steel and stainless steel	72118048YS
Ø 160/32T für steel (Ø ≤ 300)	72016032

Technical specifications	
Power input	2.400 W
Operating pressure	6 bar
Cutting depth	50,0 mm
Shank	22,2/30,0 mm
Air consumption	3,0 m ³ / min
No load speed	1.800 U/min
Height	250 mm
Air connection	R 3/3" intérieur
Noise level	98,0 dB (A)
Vibration level no load speed	< 2,5 m/s ²
Saw blades	Ø 160 - 200 mm
Net weight	12,5 kg

Accessories		Tube 400	Tube 800	Tube 1200	Tube 1600
Reference	Description				
608300	Compressed air drive unit with saw blade Ø180 / 36T	1	1	1	1
608302	Guide carriage - small	1	1	1	2
608303	Chain tensioner - small	1	1	1	2
608304	Guide chain with chain tensioner for pipes <= DN 400 mm	1			
608305	Tool kit	1	1	1	1
608306	Guide carriage - large		1	2	2
608307	Chain tensioner - large		1	2	2
608308	Tension chain		1	1	2
608309	Guide chain with chain tensioner for pipes <= DN 800 mm		1		
608310	Guide chain with chain tensioner for pipes <= DN 1200 mm			1	
60827BOX	Carry case	1	1		
608311	Steel transport box			1	1
608312	Feed tube	1	1	1	1
608313	Guide chain with chain tensioner for pipes <= DN 1600 mm				1
608314	Maintenance unit with protective housing R 3/3	x	x	x	x
608315	Water syringe 10L	x	x	x	x

x = optional





MAGPRO 35 ADJUST 1S/2S

With a large stroke and 1 or 2 speeds

Huge stroke 85 - 230 mm, allows the use of longer drills up to Ø 13 mm

- 1 or 2 speeds
- Quick release
- Core drilling / twist drilling
- 17,000 N magnetic adhesion
- Overload protection
- Integrated cooling system
- easy securing of the machine with lashing strap

Scope of delivery: lashing strap, coolant tank, tools, chip protection, carry case



Generous stroke is easily adjustable



Optional: 13 mm drill chuck & Adapter for direct use in quick release chuck
Art. 490152A



Delivery in a carry case



Magnetic chip collector
Art. 490153

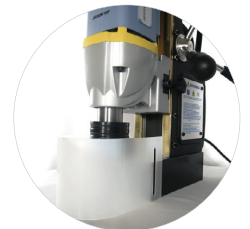

Chip protection

Technical specifications	
Power input	1.100 W
Voltage	230 V / 50 Hz
Speed Magpro 35 Adjust 1s	450 / 270 min ⁻¹ (no load / full load)
Speed Magpro 35 Adjust 2s	730 / 440 min ⁻¹ (no load / full load)
Shank	19 mm Weldon
Max. Ø core drills x L	12 - 35 x 110 mm
Max. Ø twist drills x L	13 x 140 mm
Stroke	85 mm for standard core drills, up to 230 mm for twist drills (with adapter and chuck)
Magnetic adhesion	17.000 N
Magnetic surface	175 x 90 mm
Cooling system	integrated, automatic
Net weight	14 kg (Magpro 35/1S) 15 kg (Magpro 35/2S)

Description	Reference
Magpro 35 Adjust 1s - delivery in carry case with quick release, lashing strap and tools	490150 1
Magpro 35 Adjust 2s - delivery in carry case with quick release, lashing strap and tools	490150 2
Accessories (optional)	
HSS-Co core drill set 30 mm Ø 12, 14, 16, 18, 20, 22 mm with pilot pin	490145
Carbide tipped core drill set 30 mm Ø 1x12, 1x14, 1x16, 1x18, 1x20, 1x22 mm + pilot pin	490148
„Goldfinger“ Core drill set TiN-coated 30 mm Ø 12, 14, 16, 18, 20, 22 + pilot pin	490145TiN
Drill chuck and adapter 13 mm	490152A
Adapter with Weldon 19 mm for Fein core drills with quick-in shank including + pilot pin	490154
Magnetic chip collector	490153
High performance putting oil spray for optimal cooling and higher cutting performance (400 ml)	490020



MAGPRO TP 2000

3 IN 1 AUTO REVERSE

The perfect machine for tapping in blind holes!

Tapping- and Core Drilling Machine. No electronics!

2-speed gear:

- A mode for auto reverse tapping
- A mode for core drilling and twist drilling

Including quick-release chuck for quick tool-free changing of accessories

Scope of delivery: Safety chain, coolant tank, tools, chip protection, carry case
3 adapters (see below)



Thread cutting



Twist drilling



Core drilling

Technical specifications

Power input	1.100 W
Voltage	230 V / 50 Hz
Core drilling speed	550 / 330 min ⁻¹ (no load / full load)
Twist drilling speed	550 / 330 min ⁻¹ (no load / full load)
Tapping speed	150 / 90 min ⁻¹ (no load / full load)
Shank for taps	Universal adapter M5 bis M22
Shank	19 mm Weldon
Max. Ø core drills x L	35 x 110 mm
Max. Ø twist drills x L	13 x 110 mm
Stroke	150 mm
Magnetic adhesion	15.000 N
Magnetic surface	165 x 80 mm
Cooling system	integrated, automatic
Net weight	13,7 kg

Description

Magpro TP 2000 - delivery in carry case with adapter, universal adapter for taps M5 up tp M22 (DIN, JIS, ISO), quick release for core drills and twist drills, safety chain and tools

Reference

490190N

Optional accessories

Optional accessories	Reference
Quick change inserts M5 -M22 (single)	490165M
HSS-Co core drill set 30 mm Ø 12, 14, 16, 18, 20, 22 mm + pilot pin	490145
Carbide tipped core drill set 30 mm Ø 1x12.1x14.1x16.1x18, 1x20, 1x22 mm + pilot pin	490148
„Goldfinger“ core drill set TiN-coated 30 mm Ø 12,14,16,18,20,22 + pilot pin	490145TiN
High performance cutting oil spray for optimal cooling and higher cutting performance (400 ml)	490020
Magnetic chip collector	490153

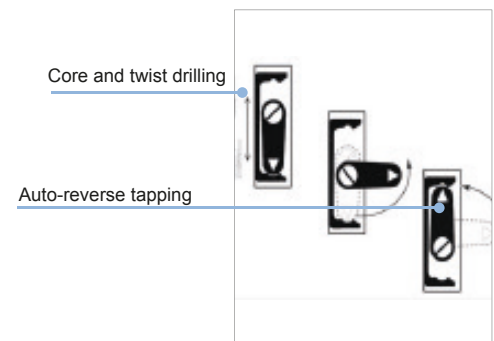
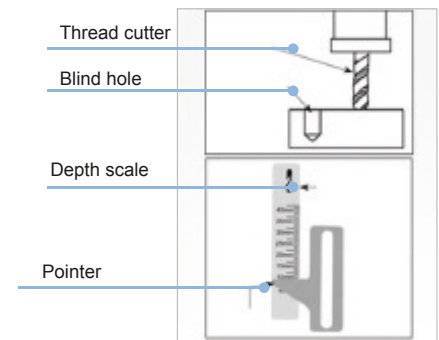

MAGPRO 35 KOMPAKT



For workspaces that were previously considered unreachable.

Scope of delivery: Security tape, chip protection, carry case



Our smallest

- Low dimensions enable working areas that were previously considered unreachable
- Maximum height of the machine 198 mm
- Core drilling up to \varnothing 35 mm (30 mm length)
- Quick release system with Weldon 19 mm shank
- Control lever can be used gradually on both sides
- Good balance for carrying
- LED light for work in dark spaces

Technical specifications

Power input	1.100 W
Voltage	230 V / 50 Hz
No load / full load speed	650 / 390 min ⁻¹
Capacity \varnothing x depth	35 mm x 30 mm
Shank	19 mm Weldon
Magnetic adhesion	15.000 N
Magnetic surface	165 x 80 mm
Dimensions	285 x 101 x 198
Net weight	10 kg

Description

Description	Reference
Magpro 35 kompakt - delivery in a carry case quick release chuck, seat belt and tools	490050

Optional accessories

Optional accessories	Reference
HSS-Co core drill set 30 mm \varnothing 12, 14, 16, 18, 20, 22 + pilot pin	490145
Carbide tipped core drill 30 mm \varnothing 1x12, 1x14, 1x16, 1x18, 1x20, 1x22 + pilot pin	490148
„Goldfinger“ core drill set TIN-coated 30 mm \varnothing 12, 14, 16, 18, 20, 22 + pilot pin	490145TiN
Twist drill set 6-11 mm Weldon 19 mm	490400Set
High performance cutting oil spray for optimal cooling and higher cutting performance (400 ml)	490020
Magnetic chip collector	490153



Twist drill set 6-11 mm Weldon 19 mm



LED light for dark work areas



Control lever can be used gradually on both sides



Balanced wearing comfort

MAGPRO 35 STANDARD



- Twist drilling up to \varnothing 13 mm
- Core drilling from \varnothing 12 - 35 mm
- Shank Weldon 19 mm

Optional:

- Core drill with pilot pin
- 13 mm core drill and adapter
- Quick release
- Magnetic chip collector
- High performance cutting oil spray

Scope of delivery:

Tension belt, coolant tank, tool, chip protection, carry case

Technical specifications

Power input	1.100 W
Voltage	230 V / 50 Hz
No load / full load speed	620 / 350 min ⁻¹
Shank	19 mm Weldon
Max. \varnothing core drills x L	12 - 35 x 50 mm
Max. \varnothing twist drills x L	13 x 110 mm
Stroke	80 mm
Magnetic adhesion	15.000 N
Magnetic surface	165 x 80 mm
Cooling system	integrated, automatic
Net weight	12 kg

Description	Reference
Magpro 35 - 230V delivery in carry case with safety chain and maintenance tools	490150

Accessories (optional)	Reference
HSS-Co core drill set 30 mm \varnothing 12, 14, 16, 18, 20, 22 mm with pilot pin	490145
Carbide tipped core drill 30 mm \varnothing 1x12, 1x 14, 1x16, 1x18, 1x20, 1x22 mm with pilot pin	490148
„Goldfinger“ core drill TiN-coated 30 mm \varnothing 12,14,16,18, 20, 22 + pilot pin	490145TiN
Drill chuck and adapter 13 mm	490152
Quick release for Magpro 35	490151
Magnetic chip collector	490153
High performance cutting oil spray for optimal cooling and higher cutting performance (400 ml)	490020



Twist drilling up to 13 mm



Optional: 13 mm drill chuck & adapter Ref. 490152



Optional: quick release
Ref. 490151



Optional: Magnetic chip collector Ref. 490153



Optional:
3 different sets
Core drill set with ejector pin



MAGPRO 35

SEMI AUTOMATIC

Core drill with automatic feed.

Scope of delivery:

Safety chain, coolant tank, tools, chip protection, carry case



The automatic feed is activated through moving the crank handle



Automatic drilling operation for core drills from Ø 14 - 30 mm manual operation from Ø 12 - 35 mm

1. 14 - 20
2. 21 - 24
3. 25 - 30



Technical specifications

Power input	1.100 W
Voltage	230 V / 50 Hz
No load / full load speed	620 / 390 min ⁻¹
Shank	19 mm Weldon, M24
Core drill max. Ø x L	12 - 35 x 55 mm
Twist drill max. Ø x L	13 x 110 mm
Max. drilling depth x Ø	50 x 35 mm (hand feed) 45 x 30 mm (auto feed)
Stroke	70 mm
Magnetic adhesion	15.000 N
Magnetic surface	165 x 80 mm
Cooling system	integrated, automatic
Net weight	17 kg

Description

Description	Reference
Magpro 35 semi automatic - 230V delivery in a carry case with safety chain, tools, chip protection	490180

Accessories (optional)

Accessories (optional)	Reference
HSS-Co core drill set 30 mm Ø 12, 14, 16, 18, 20, 22 mm with pilot pin	490145
Carbide tipped core drill 30 mm Ø 1x12, 1x 14, 1x16, 1x18, 1x20, 1x22 mm with pin pilot	490148
„Goldfinger“ core drill TiN-coated 30 mm Ø 12, 14, 16, 18, 20, 22 + pilot pin	490145TiN
Drill chuck and adapter 13 mm	490152
Quick release for Magpro 35	490151
Magnetic chip collector	490153
High performance cutting oil spray for optimal cooling and higher cutting performance (400 ml)	490020



Optional: quick release Ref. 490151



Optional: 13 mm drill chuck adapter Ref. 490152



Optional: Magnetic chip collector Ref. 490153



Delivery in carry case

MAGPRO 40/1S ADJUST SWIVEL



The Magpro 40/1S Adjust Swivel is a very compact and light machine with only 12 kg. The exclusively developed sliding system ensures an increased stability of the motor unit and thus leads to higher cutting quality. This allows precise holes up to \varnothing 40 mm.

Main features of the Magpro 40/1S Adjust Swivel:

- Very compact and lightweight design - only 12 kg
- Quick release Weldon 19 mm shank
- Exclusive swivel sliding system
- CE confirmed
- Swivelbase: 2 x 15°
- Slidingbase: 15mm
- crank lever and cooling system can be installed on both sides

Scope of delivery:

Safety chain, coolant tank, tool, chip protection, carry case



Generous stroke is easily adjustable



Optional: 13 mm drill chuck & adapter for direct use in the quick-release chuck Art. 490152A

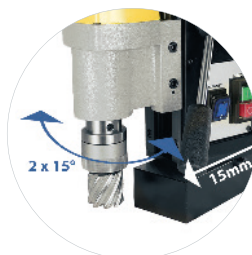

Swivel base plate: 2 x 15°
Slidable base plate: 15 mm



Crank lever and cooling system can be installed on both sides

Technical specifications

Power input	1.100 W
Voltage	230 V / 50 Hz
No load speed	450 min ⁻¹
Shank	19 mm Weldon
Core drill max. \varnothing x L	12 - 40 x 110 mm
Twist drill max. \varnothing x L	13 x 140 mm
Stroke	85 mm / 200 mm
Magnetic adhesion	10.500 N
Magnetic surface	158 x 76 mm
Cooling system	integrated, automatic
Net weight	12 kg

Description

Magpro 40 / 1s Adjust Swivel Delivery in a carry case with safety chain, maintenance equipment and coolant tank, chip protection

490140S

Accessories (optional)

Accessories (optional)	Reference
HSS-Co core drill set 30 mm \varnothing 12, 14, 16, 18, 20, 22 + pilot pin	490145
Carbide tipped core drill set 30 mm \varnothing 1x12, 1x14, 1x16, 1x18, 1x20, 1x22 mm + pilot pin	490148
„Goldfinger“ core drill set TiN-coated 30 mm \varnothing 12, 14, 16, 18, 20, 22 + pilot pin	490145TiN
Drill chuck and adapter 13 mm	490152A
Magnetic chip collector	490153
High-performance drilling and cutting oil spray for optimal cooling and higher cutting performance (Content: 400 ml)	490020

MAGPRO 40/2S

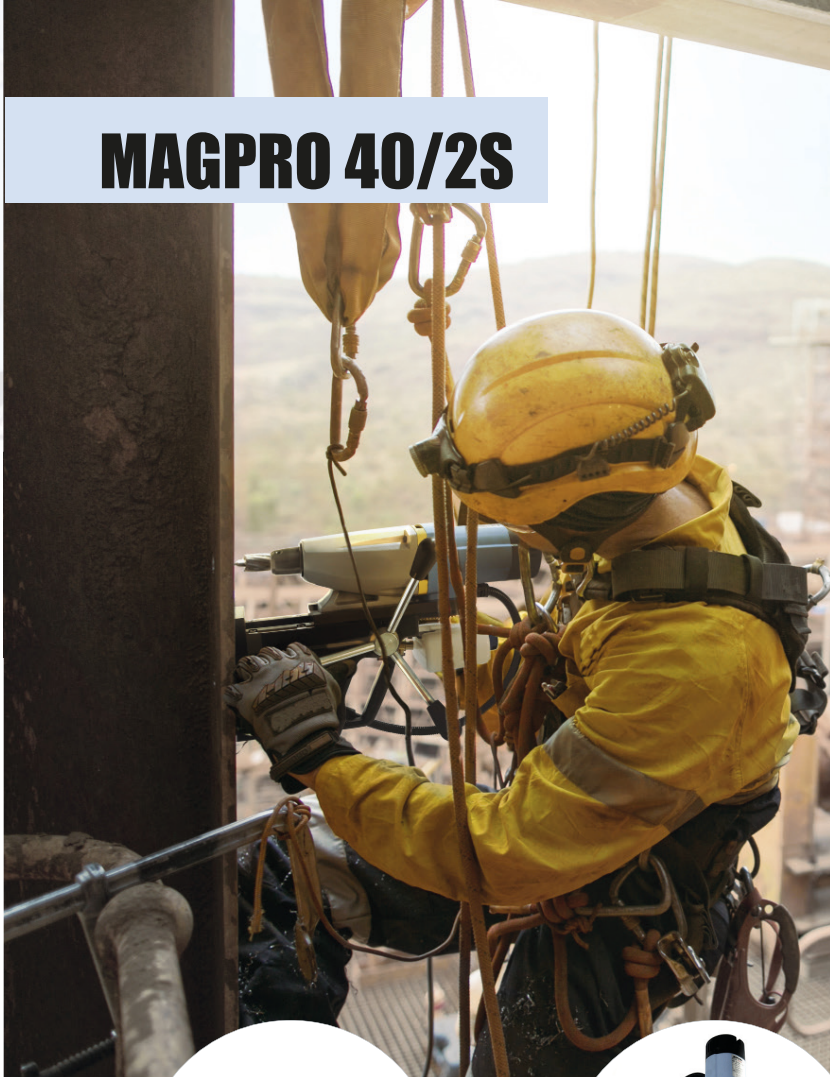

Generous stroke of 165 mm (enables, among other things, the use of longer drills)

2 speeds: 1 for core drilling and 1 for twist drilling

- 17.000 N magnetic adhesion
- Overload protection
- Integrated cooling system

Scope of delivery:

Lashing strap, coolant tank, tool, chip protection, carry case



Optional: 13 mm drill chuck & adapter for direct use in the quick-release chuck
Art. 490152A



Generous stroke is easily adjustable



Technical specifications	
Power input	1.100 W
Voltage	230 V / 50 Hz
No load/full load speeds	core drilling 650 / 465 min ⁻¹ twist drilling 1100 / 790 min ⁻¹
Shank	19 mm Weldon
Core drill max. Ø x L	12 - 40 x 110 mm
Max. twist drilling depth x Ø	13 x 140 mm
Stroke	85 mm for normal core drills, up to 165 mm for twist drill
Magnetic adhesion	17.000N
Magnetic surface	170 x 85 mm
Cooling system	integrated, automatic
Net weight	13 kg

Description	Reference
Magpro 40 / 2s delivery in a carry case with lashing strap, service equipment and coolant tank	490142
Accessories (optional)	
HSS-Co core drill set 30 mm Ø 12, 14, 16, 18, 20, 22 + pilot pin	490145
Carbide tipped core drill set 30 mm Ø 1x12, 1x 14, 1x16, 1x18, 1x20, 1x22 mm + pilot pin	490148
„Goldfinger“ core drill set TiN-coated 30 mm Ø 12, 14, 16, 18, 20, 22 + pilot pin	490145TIN
Drill chuck and adapter 13 mm	490152A
Weldon adapter 19 mm for Fein core drills with quick-in shank and + pilot pin / centering pin	490154
Magnetic chip collector	490153
High-performance drilling and cutting oil spray for optimal cooling and higher cutting performance (Content: 400 ml)	490020

MAGPRO 50/2S



Optimal core drilling with 2 speeds

- Powerful 1.800 watt motor with huge traction power

Scope of delivery:

Safety chain, coolant tank, tools, chip protection, carry case



2 speeds

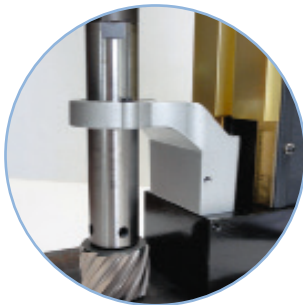

Precise core drilling up to Ø 50 mm



Optional: quick release chuck
Ref. 490172



Optional: 16 mm drill chuck & adapter
Ref. 490173



Optional: magnetic chip
collector Ref. 490153



Delivery in carry case

Technical specifications	
Power input	1.800 W
Voltage	230 V / 50 Hz
No load / full load speeds	380 / 230 min ⁻¹ 500 / 300 min ⁻¹
Shank	19 mm Weldon, M24
Core drill max. Ø x L	12 - 50 x 70 mm
Twist drill max. Ø x L	16 x 110 mm
Max. drilling depth x Ø	75 x 50 mm
Stroke	100 mm
Magnetic adhesion	32.000 N
Magnetic surface	200 x 100 mm
Cooling system	integrated, automatic
Net weight	22,9 kg

Description	Reference
Magpro 50 / 2s - 230V delivery in a carry case with safety chain and tools	490170
Accessories (optional)	Reference
HSS-Co core drill set 30 mm Ø 12, 14, 16, 18, 20, 22 + pilot pin	490145
Carbide tipped core drill set 30 mm Ø 1x12, 1x14, 1x16, 1x18, 1x20, 1x22 mm + pilot pin	490148
„Goldfinger“ core drill set TiN-coated 30 mm Ø 12, 14, 16, 18, 20, 22 + pilot pin	490145TiN
Drill chuck and adapter 16 mm	490173
Quick release for Magpro 50 / 2s	490172
Magnetic chip collector	490153
High-performance drilling and cutting oil spray for optimal cooling and higher cutting performance (Content: 400 ml)	490020



MAGPRO 50/2S

ADJUST



Core drilling up to Ø 50 mm with a large stroke and 2 speeds

- Generous stroke of 85 - 230 mm
- 2 speeds
- Quick release chuck
- Core drilling
- Twist drilling
- 17,000 N magnetic holding force
- Overload protection
- Integrated cooling system

Scope of delivery:

Safety chain, coolant tank, tools, chip protection, carry case

2 speeds



Delivery in a carry case



Optional: Drill chuck with Weldon 19 mm adapter for full drills

Optional: Drill chuck & adapter
Art. 490152A



Technical specifications	
Power input	1.100 W
Voltage	230 V / 50 Hz
No load / full load speeds	300 / 180 min ⁻¹ 400 / 170 min ⁻¹
Shank	19 mm Weldon
Core drill max. Ø x L	12 - 50 x 110 mm
Twist drill max. Ø x L	13 x 140 mm
Stroke	85 - 230 mm
Magnetic adhesion	17.000 N
Magnetic surface	175 x 90 mm
Cooling system	integrated, automatic
Net weight	15,0 kg

Description	Reference
Magpro 50 / 2s Adjust - delivery in a carry case with quick-release chuck, safety chain and tools	490170 2
Accessories (optional)	
HSS-Co core drill set 30 mm Ø 12, 14, 16, 18, 20, 22 + pilot pin	490145
Carbide tipped core drill set 30 mm Ø 1x12, 1x 14, 1x16, 1x18, 1x20, 1x22 mm + pilot pin	490148
„Goldfinger“ core drill set TiN-coated 30 mm Ø 12, 14, 16, 18, 20, 22 + pilot pin	490145TIN
Drill chuck and adapter 13 mm	490152A
Adapter Weldon 19 mm for Fein core drills with Quick-in holder + pilot pin / centering pin	490154
Magnetic chip collector	490153
High-performance drilling and cutting oil spray for optimal cooling and higher cutting performance (Content: 400 ml)	490020

MAGPRO 75/4S



The robust allrounder with 4 speeds:
twist drilling, core drilling & tapping



Scope of delivery:

Safety chain, coolant tank, tool, chip protection, ejector wedge, case, CM3 / Weldon 19

Optional:

Pipefix - pipe clamping system
Clamping range from 32 to 600 mm
Ref. 490010big



Delivery in a carry case



Optional: drill chuck 16 mm
and adapter Art. 490164

Thread cutting



Technical specifications	
Power input	1.800 W
Voltage	230 V / 50 Hz
No load / full load speeds	1: 210 / 120 min ⁻¹ 2: 270 / 160 min ⁻¹ 3: 410 / 290 min ⁻¹ 4: 530 / 310 min ⁻¹
Shank	19/32 mm Weldon, CM3
Max. Ø core drills x L	12 - 75 x 75 mm
Max. Ø twist drills x L	16 x 110 mm
Max. Ø twist drills x L CM3	32 x 150 mm
Max. drilling depth x Ø	75 x 75
Stroke	100 mm
Magnetic adhesion	32.000 N
Magnetic surface	200 x 100 mm
Cooling system	integrated, automatic
Net weight	24,8 kg

Description	Reference
Delivery 75/4s - 230V in carry case with safety chain, tools and CM3 / 19 mm adapter	490160
Accessories (optional)	Reference
HSS-Co core drill set 30 mm Ø 12, 14, 16, 18, 20, 22 + pilot pin	490145
Carbide tipped core drill set 30 mm Ø 1x12, 1x 14, 1x16, 1x18, 1x20, 1x22 mm + pilot pin	490148
„Goldfinger“ core drill set TiN-coated 30 mm Ø 12, 14, 16, 18, 20, 22 + pilot pin	490145TiN
CM3 quick change adapter set for thread cutter shank	490162
Quick change insert M3-M14 (single)	490162 M3-14
CM3 quick change adapter set for thread cutter shank M5-M22	490165
Quick change insert M5-M22 (single)	490165 M5-22
Weldon 32/CM3 adapter for magnetic drills from Ø 61 mm	490163
Drill chuck and adapter 16 mm	490164
Pipefix pipe clamping system for pipes Ø 32 - 127 mm	490010
Pipefix pipe clamping system for pipes Ø 32 - 600 mm	490010BIG
High-performance drilling and cutting oil spray (400 ml)	490020
Magnetic chip collector	490153



MAGPRO 75/4S

SWIVEL BASE

Scope of delivery:

Safety chain, coolant tank, tool, chip protection and ejector wedge, carry case, CM3 / Weldon 19



Optional: Drill chuck 16 mm and adapter Ref. 490164

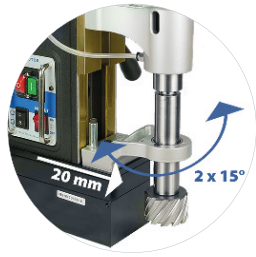

The magnetic base can swivel 15 degrees left and right and 20 mm forward. The adjustable magnetic base allows precise positioning of the core, thread and twist drills.

Core drilling



Thread cutting



Twist drilling with CM3-adapter



Technical specifications

Power input	1.800 W
Voltage	230 V / 50 Hz
No load / full load speeds	1: 210 / 120 min ⁻¹ 2: 270 / 160 min ⁻¹ 3: 410 / 290 min ⁻¹ 4: 530 / 310 min ⁻¹
Shank	19/32 mm Weldon, CM3
Max. Ø core drills x L	12 - 75 x 75 mm
Max. Ø twist drills x L	16 x 110 mm
Max. Ø twist drills x L CM3	32 x 150 mm
Max. drilling depth x Ø	75 x 75 mm
Stroke	100 mm
Magnetic adhesion	32.000 N
Magnetic surface	200 x 100 mm
Cooling system	integrated, automatic
Net weight	27 kg

Description

Magpro 75 / 4s swivel base - 230V delivery in a carry case with safety chain, tool and CM3 / 19 mm adapter

Reference

490160S

Accessories (optional)

Accessories (optional)	Reference
HSS-Co core drill set 30 mm Ø 12, 14, 16, 18, 20, 22 + pilot pin	490145
Carbide tipped core drill set 30 mm Ø 1x12, 1x 14, 1x16, 1x18, 1x20, 1x22 mm + pilot pin	490148
„Goldfinger“ core drill set TiN-coated 30 mm Ø 12, 14, 16, 18, 20, 22 + pilot pin	490145TiN
MT3 quick change adapter set for thread cutter shank	490162
Quick change insert M3-M14 (single)	490162 M3-14
CM3 quick change adapter set for thread cutter shank M5-M22	490165
Quick change insert M5-M22 (single)	490165 M5-22
Weldon 32/CM3 adapter for magnetic drills from Ø 61 mm	490163
Drill chuck and adapter 16 mm	490164
High-performance drilling and cutting oil spray (400 ml)	490020
Magnetic chip collector	490153

MAGPRO 80/4S



- Core drilling up to \varnothing 80 mm
- 4 speeds for core drilling
- Twist drilling up to \varnothing 16 mm
- Generous stroke of 270 mm
- Enables, among other things, the use of longer fine drills
- 17.000 N Magnetic adhesion
- Overload protection
- Integrated cooling system

Scope of delivery:

Lashing strap, coolant tank, tool, chip protection, ejector wedge, carry case, CM3 / Weldon 19



Generous stroke is easily adjustable



Drill chuck 16 mm & CM3 adapter Ref. 490164



Optional: CM3 / Quick Release Weldon 19 Ref. 490168



Very narrow design

Technical specifications	
Power input	1.600 W
Voltage	230 V / 50 Hz
No load / full load speeds	1: 190 / 105 min ⁻¹ 2: 300 / 165 min ⁻¹ 3: 420 / 230 min ⁻¹ 4: 660 / 365 min ⁻¹
Shank	19/32 mm Weldon, CM3
Max. \varnothing core drills x L	12 - 80 mm x 110 mm
Max. \varnothing twist drills x L	16 x 110 mm
Max. \varnothing twist drills x L x CM3	32 x 150 mm
Stroke	85 mm for normal core drills, up to 270 mm for twist drills (with adapter and chuck)
Magnetic adhesion	17.000N
Magnetic surface	220 x 110 mm
Cooling system	integrated, automatic
Net weight	24 kg

Description	Reference
Magpro 80 4S - delivery in carry case with quick release, lashing strap and tools	490184
Accessories (optional)	Reference
HSS-co core drill set 30 mm \varnothing 12, 14, 16, 18, 20, 22 mm + pilot pin	490145
Carbide tipped core drill set 30 mm \varnothing 12, 14, 16, 18, 20, 22 mm + pilot pin	490148
„Goldfinger“ core drill set TiN-coated 30 mm \varnothing 12, 14, 16, 18, 20, 22 + pilot pin	490145TiN
Drill chuck 16 mm + MK3 adapter	490164
Weldon 32 CM3 adapter for core drills from \varnothing 61 mm	490163
Adapter with Weldon 19 mm for Fein core drills with Quick-in shank including 1 ejector pin	490154
Magnetic chip collector	490153
High performance cutting oil spray for optimal cooling and higher cutting performance (400 ml)	490020

MAGPRO 120/4S



The biggest allrounder with 4 speeds

- Core drilling up to \varnothing 120 mm
- The stepless adjustable electronic speed control also enables an optimal adjustment of rotation speed

Scope of delivery:

Lashing strap, coolant container, tools, chip protection, ejector wedge, carry case, Weldon 19, CM3, Weldon 32



Transport case with wheels



Optional: CM3 Quick change adapter for thread cutter shank M5-M22 Ref. 490165



Core drilling



Thread cutting



Twist drilling with CM3-adapter

Technical specifications	
Power input	2000 W
Voltage	230 V / 50 Hz
No load / full load speeds	1: 120 / 35 min ⁻¹ 2: 220 / 70 min ⁻¹ 3: 250 / 80 min ⁻¹ 4: 450 / 140 min ⁻¹
Shank	19/32 mm Weldon, CM3
Max. \varnothing core drills x L	12 - 120 x 75 mm
Max. \varnothing twist drills x L	16 x 110 mm
Max. \varnothing twist drills x L CM3	32 x 150 mm
Max. drilling depth x \varnothing	75 x 120 mm
Stroke	100 mm
Magnetic adhesion	32.000 N
Magnetic surface	200 x 100 mm
Cooling system	integrated, automatic
Net weight	30 kg

Description	Reference
Delivery in a carry case with safety chain, maintenance tools and CM3/19 mm adapter for core drills \varnothing 12 - 60 mm and CM3/32 mm adapter for core drills \varnothing 61mm	490100
Accessories (optional)	Reference
HSS-co core drill set 30 mm \varnothing 12, 14, 16, 18, 20, 22 mm + pilot pin	490145
Carbide core drill set 30 mm \varnothing 12, 14, 16, 18, 20, 22 mm + pilot pin	490148
„Goldfinger“ TiN core drill set 30 mm \varnothing 12, 14, 16, 18, 20, 22 mm + pilot pin	490145TiN
CM3 Quick change adapter for thread cutter shank M3-M14	490162
Quick change inserts M3-M14 (single)	490162 M3-14
MT3 Quick change adapter for thread cutter shank M5-M22	490165
Quick change inserts M5-M22 (single)	490165 M5-22
Drill chuck 16 mm and adapter	490164
Magnetic chip collector	490153
High performance cutting oil spray for optimal cooling and higher cutting performance (400 ml)	490020

MAGPRO 52 AIR

MADE
IN
GERMANY



Air-operated magnetic core drilling with a huge stroke

Scope of delivery:

Safety chain, coolant tank, tool,
chip protection, carry case

- Air-operated magnetic drill for work in hazardous and wet environments
- ATEX/CEN approved, no electricity
- Core drilling up to \varnothing 52 mm
- Twist drilling up to \varnothing 13 mm
- Huge stroke up to 260 mm
- Magnetic adhesion: 8.000 N
- Integrated cooling system



ATEX/ CEN approved



Technical specifications

Operating pressure	6 bar
Motor output	1.000 W
No load / full load speed	400 / 200 min ⁻¹
Air consumption	1,8 m ³ /min
Air connection	R 3/8" i
Shank	19 mm Weldon
Max. \varnothing core drills	52 mm
Max. \varnothing twist drills	13 mm
Stroke	260 mm
Magnetic adhesion	8.000 N
Magnetic surface	216 x 86 MM
Cooling system	automatic, external
Net weight	21,5 kg

Description

Description	Reference
Magpro 52 Air - delivery in carry case with safety chain, maintenance tools and pressurized lubrication system	490000

Accessories (optional)

Accessories (optional)	Reference
HSS-co core drill set 30 mm \varnothing 12, 14, 16, 18, 20, 22 mm + pilot pin	490145
Carbide tipped core drill set 30 mm \varnothing 12, 14, 16, 18, 20, 22 mm + pilot pin	490148
„Goldfinger“ core drill set TiN-coated 30 mm \varnothing 12, 14, 16, 18, 20, 22 + pilot pin	490145TiN
Drill chuck and adapter 13 mm	490152A
Magnetic chip collector	490153
High performance cutting oil spray for optimal cooling and higher cutting performance (400 ml)	490020



Optional drill chuck with Weldon 19 mm adapter for twist drills

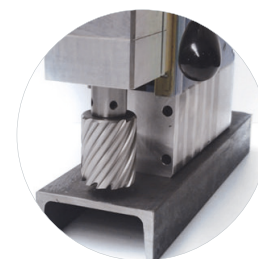

Core drilling up to \varnothing 52 mm



Supplied with safety chain, tools and external coolant pressure tank



Optional: drill chuck & adapter 13 mm Ref. 490152A

UNIVERSALLY APPLICABLE ACCESSORIES

Accessories	Description	Reference	Accessories	Description	Reference
	13 mm drill chuck with adapter 19 mm (Magpro Adjust series) 13 mm for Magpro 35 16 mm for Magpro 50	490152A 490152 490173		Drill chuck 16 mm, CM3 adapter	490164
	Quick release Weldon 19 mm for Magpro 35 for Magpro 50 for Magpro 80	490151 490172 490168		Adapter with Weldon 19 mm for FEIN® core drills > 50 mm with Quick-in holder, 1 ejector / centering pin	490154
	Weldon 32 mm CM3 industrial adapter for core drills Ø 61 mm with automatic internal lubrication	490163		CM3 quick change adapter M3 to M14 M5 to M22	490162 490165
	Magnetic chip collector for removing drill chips	490153		Quick change inserts M3 to M14 (single) M5 to M22 (single)	490162 M3-14 490165 M5-22
	Cooling lubricant pin for taps and saw blades before use (content: 350 g)	740860		High-performance drilling and cutting oil spray for optimal cooling and higher cutting performance (400ml)	490020

DIMENSIONS IN MM

MAGPRO TP 2000

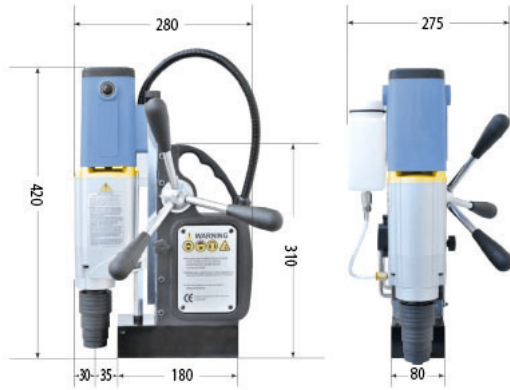

MAGPRO 35 Kompakt

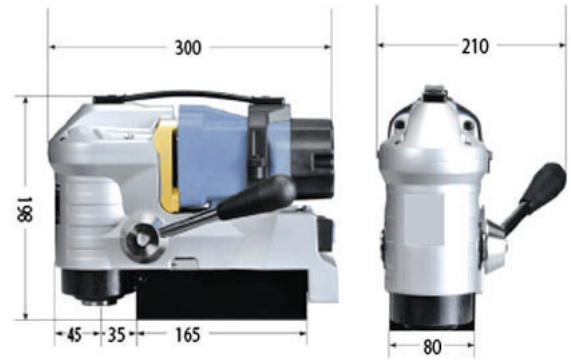

MAGPRO 35 Semi Automatic

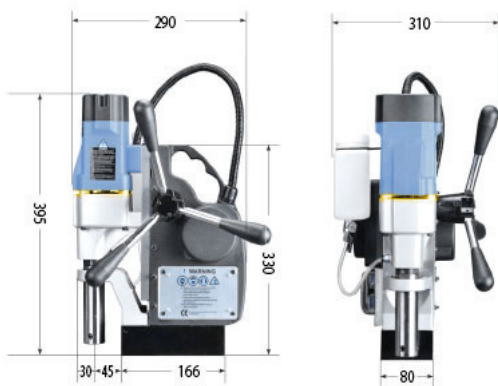

MAGPRO 40/1s Adjust

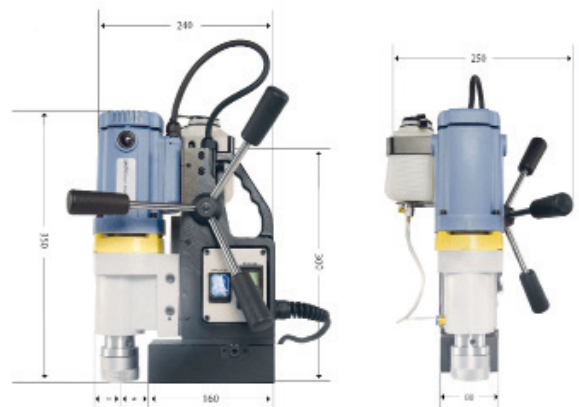

MAGPRO 75/4s

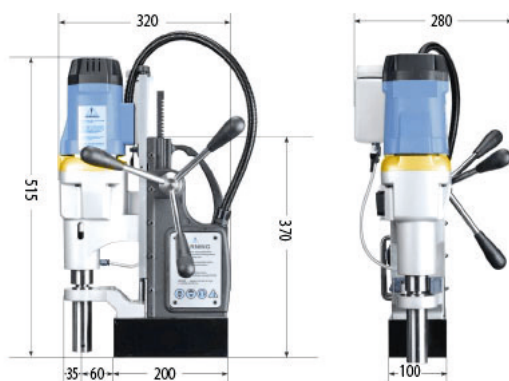

MAGPRO 75/4s Swivel Base

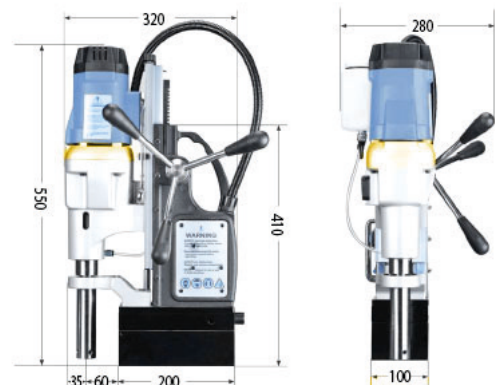

MAGPRO 35

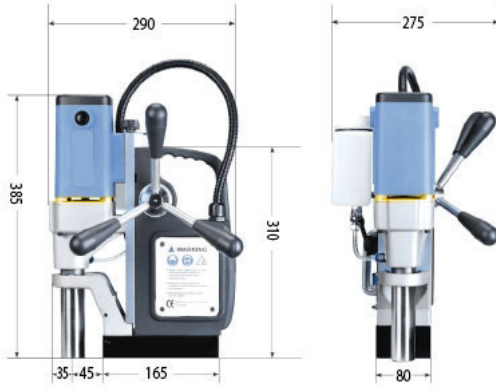

MAGPRO 35/1s, 35/2s, 50/2s Adjust

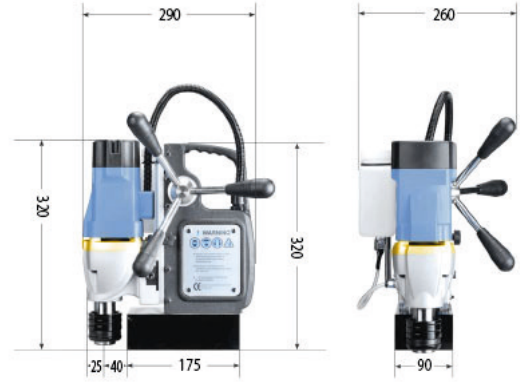

MAGPRO 40/2s

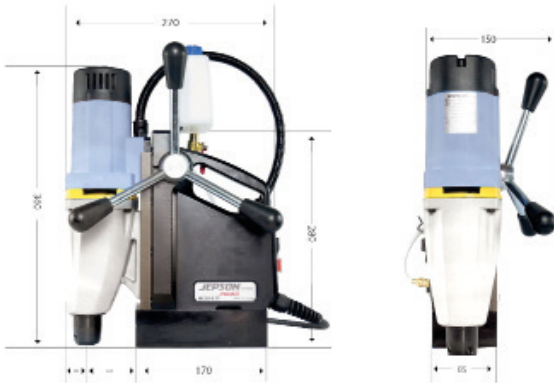

MAGPRO 50/2s

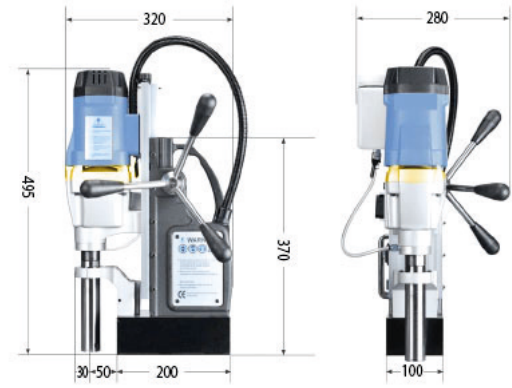

MAGPRO 80/4s

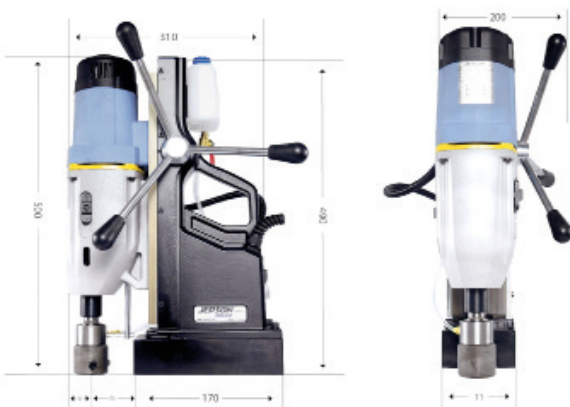

MAGPRO 120/4s

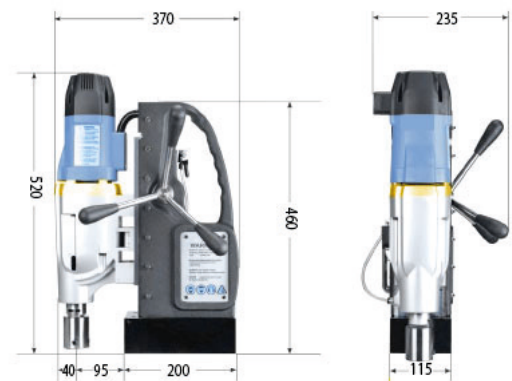



HSS-CO CORE DRILL

DRILLING FASTER AND MORE ECONOMICALLY



CORE DRILL BY JEPSON POWER

With our core drills, the machining area is reduced to a minimum. This makes the drilling process more economical and faster, and longer tool life is achieved. The result is particularly precise holes without pre-drilling.

In combination with Jepson Power's Magpro magnetic core drilling machines, our core drills are suitable for machining steel and stainless steel.

Properties of our core drills

- High heat resistance ✓
- High wear protection ✓
- Cobalt content ✓
- Weldon shank 19 mm or 32 mm ✓
- Regrindable ✓

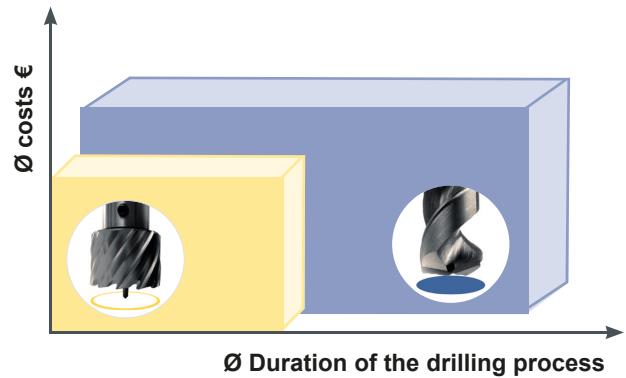

Core drilling is considerably cheaper than twist drilling and drastically reduces the duration of the drilling process.

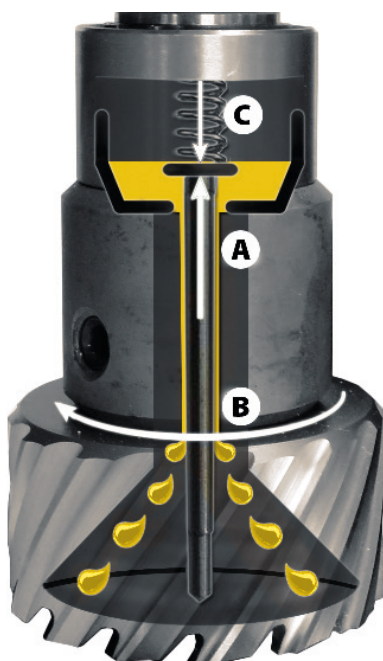

A
B
C

INTEGRATED COOLANT SUPPLY

When the core drill is placed, the coolant supply is started via the ejector pin

The rotation of the core drill distributes the coolant to the desired locations.

At the end of the drilling process, the tensioned spring ejects the pin and the coolant supply is automatically stopped.

CORE DRILL HSS-CO

Drill faster and more economically
with core drills by Jepson Power!
Fully hardened HSS Co core drills *

HSS-Co Core drill - short

> Ø 12 - 60 mm
> 30 mm cutting depth
> 19 mm Weldon shank
for drills up to Ø 60 mm



Ø mm	Ref.	Ø mm	Ref.
12S	490212	36S	490236
13S	490213	37S	490237
14S	490214	38S	490238
15S	490215	39S	490239
16S	490216	40S	490240
17S	490217	41S	490241
18S	490218	42S	490242
19S	490219	43S	490243
20S	490220	44S	490244
21S	490221	45S	490245
22S	490222	46S	490246
23S	490223	47S	490247
24S	490224	48S	490248
25S	490225	49S	490249
26S	490226	50S	490250
27S	490227	51S	490251
28S	490228	52S	490252
29S	490229	53S	490253
30S	490230	54S	490254
31S	490231	55S	490255
32S	490232	56S	490256
33S	490233	57S	490257
34S	490234	58S	490258
35S	490235	59S	490259
		60S	490260

HSS-Co Core drill - short

> Ø 61 - 130 mm
> 30 mm cutting depth
> 32 mm Weldon shank
for drills from Ø 61 mm



Ø mm	Ref.	Ø mm	Ref.
61S	490261	83S	490283
62S	490262	84S	490284
63S	490263	85S	490285
64S	490264	86S	490286
65S	490265	87S	490287
66S	490266	88S	490288
67S	490267	89S	490289
68S	490268	90S	490290
69S	490269	91S	490291
70S	490270	92S	490292
71S	490271	93S	490293
72S	490272	94S	490294
73S	490273	95S	490295
74S	490274	96S	490296
75S	490275	97S	490297
76S	490276	98S	490298
77S	490277	99S	490299
78S	490278	100S	4902100
79S	490279	110S	4902110
80S	490280	120S	4902120
81S	490281	130S	4902130
82S	490282		

Pilot pin for core drills Ø 12 - 60 mm Weldon 19

Ø mm	Ref.
Pilot pin 075	490200

Pilot pin for core drills Ø 61 - 100 mm Weldon 32

Ø mm	Ref.
Pilot pin 090	490201

* Co-content variable



HSS-Co Core drill - long

- > Ø 12 - 60 mm
- > 50 mm cutting depth
- > 19 mm Weldon shank
for drills up to Ø 60 mm



Ø mm	Ref.	Ø mm	Ref.
12L	490512	36L	490536
13L	490513	37L	490537
14L	490514	38L	490538
15L	490515	39L	490539
16L	490516	40L	490540
17L	490517	41L	490541
18L	490518	42L	490542
19L	490219	43L	490543
20L	490520	44L	490544
21L	490521	45L	490545
22L	490522	46L	490546
23L	490523	47L	490547
24L	490524	48L	490548
25L	490525	49L	490549
26L	490526	50L	490550
27L	490527	51L	490551
26L	490526	52L	490552
27L	490527	53L	490553
28L	490528	54L	490554
29L	490529	55L	490555
30L	490530	56L	490556
31L	490531	57L	490557
32L	490532	58L	490558
33L	490533	59L	490559
34L	490534	60L	490560
35L	490535		

Pilot pin for core drills Ø 12 - 60 mm Weldon 19

Ø mm	Ref.
Pilot pin 100	490500

HSS-Co Core drill - long

- > Ø 61 - 130 mm
- > 50 mm cutting depth
- > 32 mm Weldon shank
for drill from Ø 61 mm



Ø mm	Ref.	Ø mm	Ref.
61L	490561	83L	490583
62L	490562	84L	490584
63L	490563	85L	490585
64L	490564	86L	490586
65L	490565	87L	490587
66L	490566	88L	490588
67L	490567	89L	490589
68L	490568	90L	490590
69L	490569	91L	490591
70L	490570	92L	490592
71L	490571	93L	490593
72L	490572	94L	490594
73L	490573	95L	490595
74L	490574	96L	490596
75L	490575	97L	490597
76L	490576	98L	490598
77L	490577	99L	490599
78L	490578	100L	4905100
79L	490579	110L	4905110
80L	490580	120L	4905120
81L	490581	130L	4905130
82L	490582		

Pilot pin for core drills Ø 61 - 100 mm Weldon 32

Ø mm	Ref.
Pilot pin 120	490501

THE GOLDFINGER

THE HIGH-PERFORMANCE CORE DRILL TIN COATED

Fully hardened, TiN coated HSS core drills:
from Ø 12 mm (490212TiN) to Ø 60 mm (490260TiN)
with 19 mm Weldon shaft and 30 mm cutting depth.



Reference	Ø [mm]
490200	Pilot pin 075 (Weldon 19)
490212TiN	12
490213TiN	13
490214TiN	14
490215TiN	15
490216TiN	16
490217TiN	17
490218TiN	18
490219TiN	19
490220TiN	20
490221TiN	21
490222TiN	22
490223TiN	23
490224TiN	24
490225TiN	25
490226TiN	26
490227TiN	27
490228TiN	28
490229TiN	29
490230TiN	30
490231TiN	31
490232TiN	32
490233TiN	33
490234TiN	34
490235TiN	35

Reference	Ø [mm]
490236TiN	36
490237TiN	37
490238TiN	38
490239TiN	39
490240TiN	40
490241TiN	41
490242TiN	42
490243TiN	43
490244TiN	44
490245TiN	45
490246TiN	46
490247TiN	47
490248TiN	48
490249TiN	49
490250TiN	50
490251TiN	51
490252TiN	52
490253TiN	53
490254TiN	54
490255TiN	55
490256TiN	56
490257TiN	57
490258TiN	58
490259TiN	59
490260TiN	60
490145TiN	Set Ø 12, 14, 16, 18, 20, 22 mm + pilot pin



TiN means very high abrasion resistance and low reactivity. Therefore tool wear is significantly reduced by coating. The TiN coating enables the machining of hard steels such as ST 52 and stainless steel (in contrast to HSS-Co for conventional steels)

Range

- Fully hardened, TiN coated HSS core drills
- Range from Ø 12 mm (490212TiN) to Ø 60 mm (490260TiN) with Weldon shaft 19 mm
- Cutting depth 30 mm
- Set 490145TiN 12, 14, 16, 18, 20, 22 + ejector pin



Coating properties

Hardness	2.300 ± 200 HV
Maximum temperature	500 °C / 930 °F
Coefficient of friction in steel	0,6
Coating thicknesses	1 - 4 µm
Colour	gold

The machining comparison in tool steel ST 52 thickness 20 mm

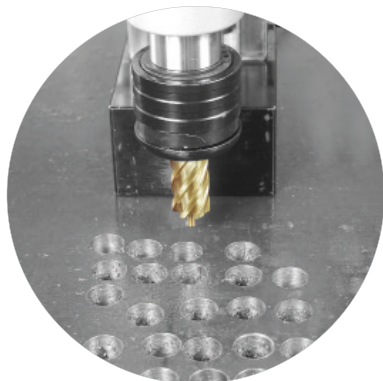

TiN drill Ø 20 mm
More than 29 drill holes
Bore in 28 seconds

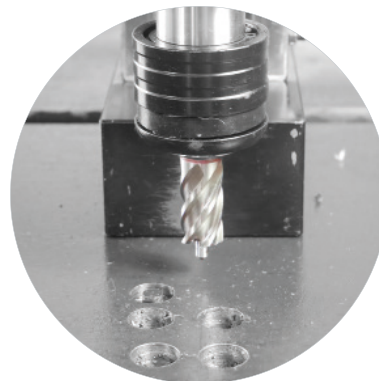

HSS-Co Ø 20 mm
5 drill holes
Bore in 42 seconds

CORE DRILL SETS

MADE
IN
GERMANY



The Goldfinger

The high-performance core drill TiN coated
Ref. 490145TiN

- Ø 12, 14, 16, 18, 20, 22 mm + ejector pin
- Cutting depth: 30 mm
- 19 mm Weldon shank
- High abrasion resistance and low reactivity
- Increased tool life



HSS-Co core drill set

Ref. 490145

- Ø 12, 14, 16, 18, 20, 22 mm + pilot pin
- Cutting depth: 30 mm
- Weldon shank 19 mm
- Full-grinding technology
- Increased tool life
- Improved chip flow



Carbide tipped core drill set

Ref. 490148

- Ø 12, 14, 16, 18, 20, 22 mm + pilot pin
- Cutting depth: 35 mm
- Weldon shank 19 mm
- Core drilling in stainless steel
- Increased tool life
- Improved chip flow

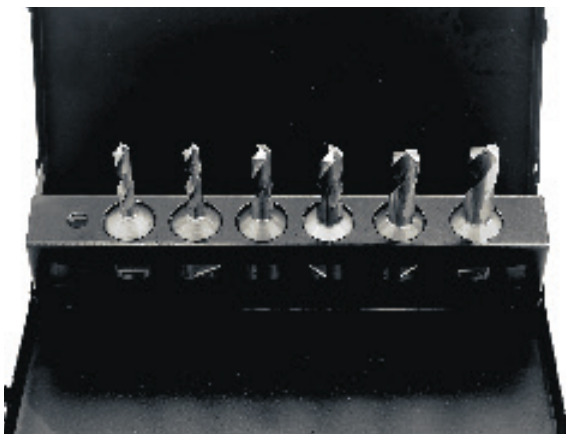

Twist drill set HSS

Ref. 490400SET

- Ø 6, 7, 8, 9, 10, 11 mm
- Cutting depth: 30 mm
- Weldon shank 19 mm
- Drilling in confined spaces

OUR WEBSITE

Visit us online at
www.drycutter.com

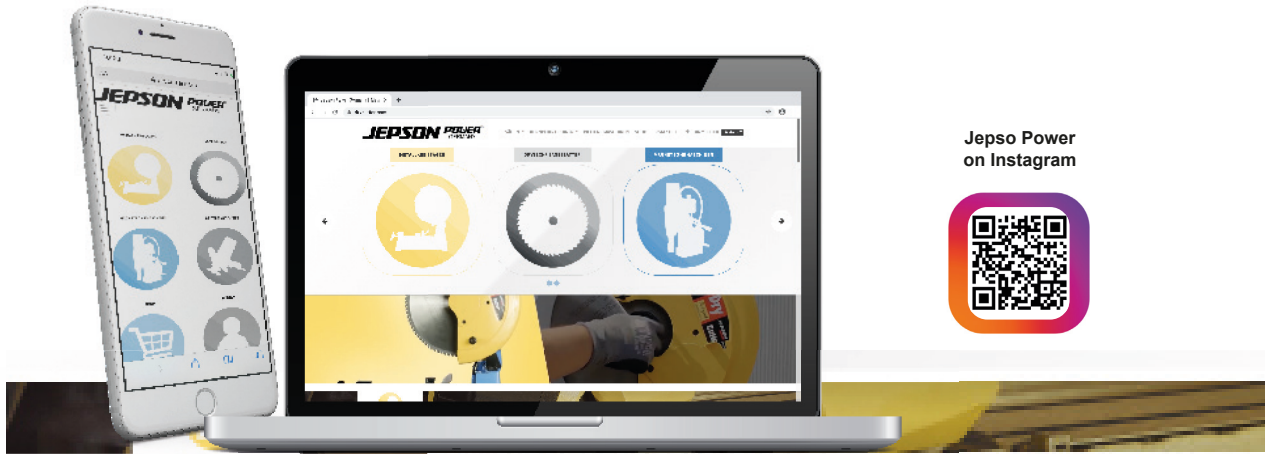

Jepso Power
 on Instagram

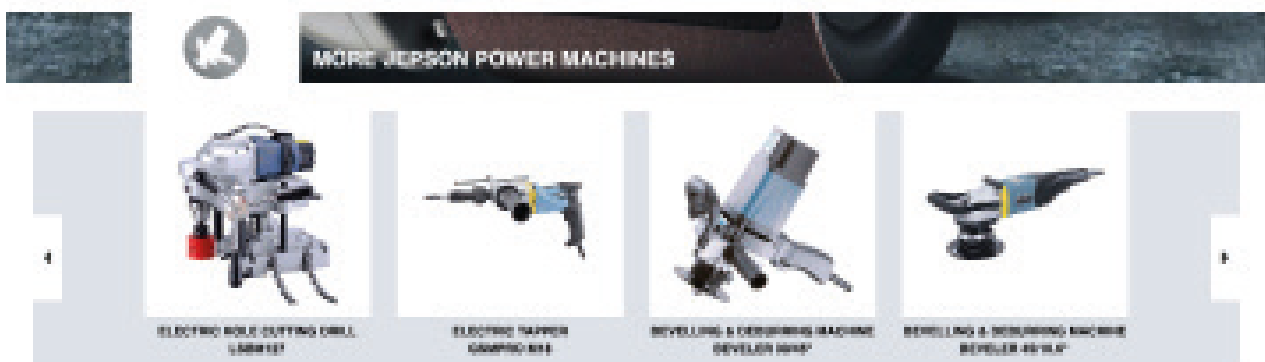
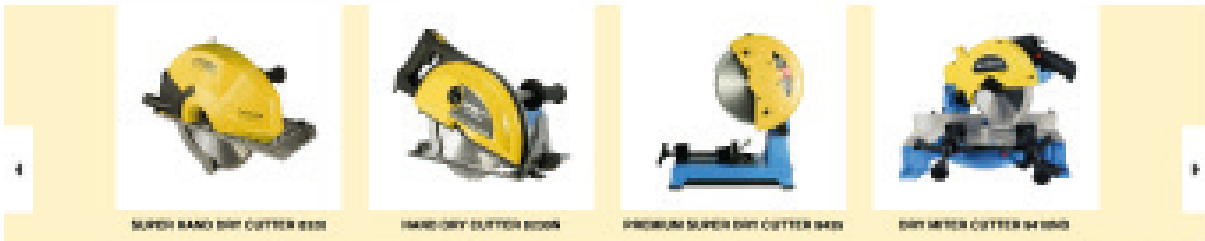





LSBM127

ELECTRIC HOLE CUTTING DRILL

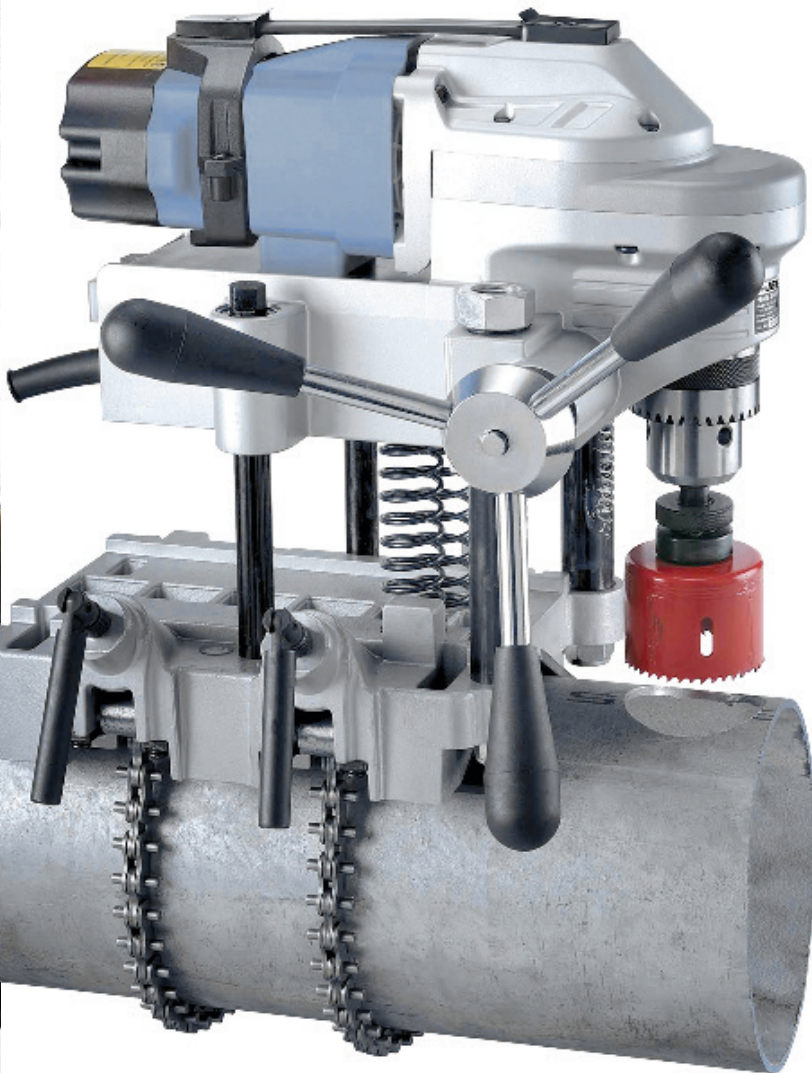

- Ideal for quickly drilling holes up to Ø 127 mm in tubes with Ø 32 - 203 mm, with an optional chain set also suitable for tubes up to Ø 600 mm
- Built-in bubble level for an easy alignment of the drill
- The tool free quick-release handle can be mounted on either side
- Overload protection



The tool free quick-release handle can be mounted on both sides



Built-in bubble levels



Chain system is quickly mounted

Technical specifications

Power input	1.100 W
Voltage	230 V / 50 Hz
No load speed	130 min ⁻¹
Drill chuck capacity	1 - 16 mm
Max. cutting capacity	Ø 127 mm
Pipe clamping capacity	Ø 32 - 203 mm optional 32 - 600 mm
Insulation class:	1 single
Overload protection	integrated
Net weight	14,5 kg
Dimensions	319 x 270 x 302 mm
Cable length	2,5 m

Description

Electric hole cutting drill for pipes Ø 32 - 203 mm
Delivery in a carry case with drill chuck adapter 16 mm,
cranc handle set and maintenance tool

Reference

490060

Accessories (optional)

Long chain set for pipes Ø 32 - 600 mm

Reference

490061

GSMPRO M18 ELECTRIC TAPPER



The M18 tapper makes it convenient and easy to tap a series of holes quickly. The special gear box design gives the operator precise control:

- The tool will not move without pressure on the spindle
- By pressing the spindle, clockwise rotation is activated at low speed (280 min⁻¹)
- Pulling the spindle activates counterclockwise rotation at a higher speed (680 min⁻¹)

The motor was specially developed for this task, with high torque, low speed and high concentricity. This allows the user a controllable power call and makes the M18 the ideal tool for thread cutting in just one work step. The universal holder for standard thread cutters (M6-M18) reliably prevents possible material breakages in the tool used. The ergonomic handle helps the operator to keep the tap straight. The machine has an additional side handle to counteract the leverage. Equipped with a depth stop for tapping in blind holes.

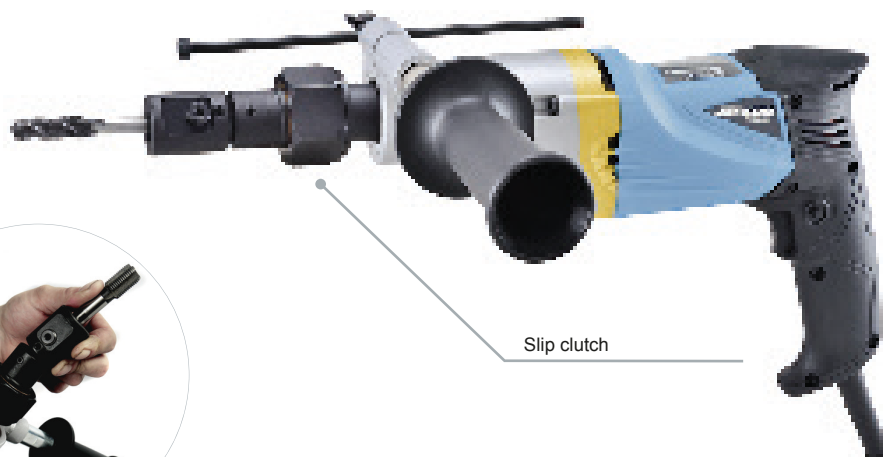

Delivery in a carry case



Flexible thread holder

Technical specifications	
Power input	450 W
Voltage	230 V / 50 Hz
No load speed	right: 280 min ⁻¹ left: 680 min ⁻¹
Tapping range	M6 - M18
Max. tapping capacity	in steel: 18 mm in aluminum: 16 mm
Insulation class	1 single
Overload protection	integrated
Net weight	3,15 kg
Dimensions	400 x 80 x 200 mm
Cable length	3 m

Description	Reference
Delivery in a carry case with safety clutch, side handle, depth stop and maintenance tool	495090



ELECTRIC BEVELER 30° / 45° DEBURRING MACHINE

- Excellent for following curved shapes and forms, perfect for working on round and flat surfaces
- Variable speed for working with a variety of materials
- Complete with 30° & 45° toolholders with 3 carbide inserts
- Uses standard triangle carbide inserts
- Change of inserts quick & easy - tool-free
- Precise tool-free bevel depth adjustment
- Overload protection

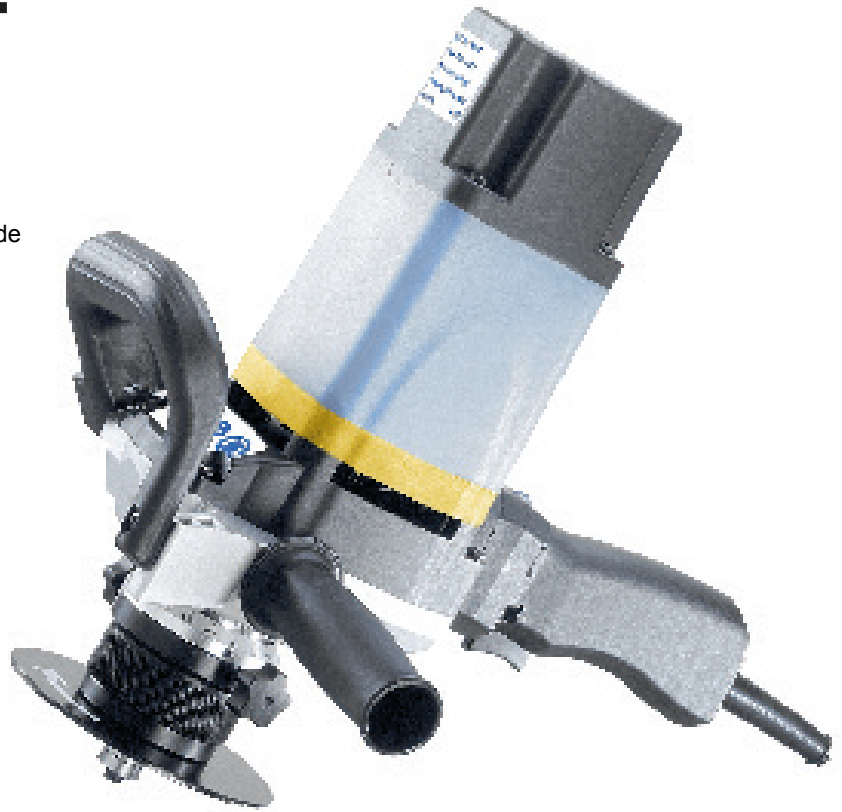

Versatile deburring and chamfering of contours, radii and countersink holes, 30° weld seam and visual edge preparation etc.

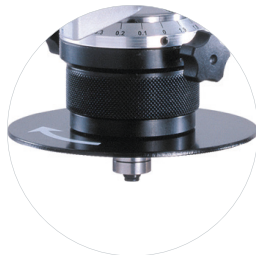

Tool-free adjustable bevel height and scale



Toolholder with 3 carbide inserts



Optional: Carbide inserts
Ref.: 495001

Technical specifications	
Power input	1.200 W
Voltage	230 V / 50 Hz
Speed	3000 - 6000 min ⁻¹
Bevel angle	30° und 45°
Max. bevel height	6 mm
Smallest inner diameter:	22 mm
Net weight	4,7 kg

Description	Reference
Delivery in a carry case with 30° & 45° tool holder and 3 carbide inserts	495000N
Accessories (optional)	Reference
Set of 10 triangel carbide inserts	495001



ELECTRIC BEVELER 45 / 10.6

BEVELLING AND DEBURRING MACHINE



- Excellent for following curved shapes and forms as well as for working on round and flat surfaces.
- Beveling and deburring starts at 30 mm inner diameter
- Variable speed for working with a variety of materials
- Complete with 45° toolholder with 6 carbide inserts
- Uses four sided carbide inserts
- Change of inserts quick & easy without special tools
- Bevel depth adjustment without tools, directly on the machine
- Overload protection



Tool-free adjustable bevel height and scale



With 45° toolholder



Beveling and deburring starts at 30 mm inner diameter

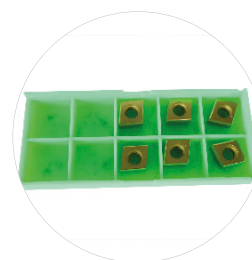

Optional:
Set of 6 carbide inserts
Ref.: 495011

Technical specifications	
Power input	1.800 W
Voltage	230 V / 50 Hz
Speeds	2.300, 2.600, 3.700, 4.800, 5.800, 6.500 min ⁻¹
Bevel angle	45° (30° & 37,5° optional)
Max. bevel height 45°	10,6 mm
Smallest inner diameter	30 mm
Net weight	6,5 kg

Description	Reference
Delivery in carry case with 45° toolholder with 6 carbide inserts and maintenance tools	495010
Accessories (optional)	Reference
Set of 6 carbide inserts	495011
Toolholder 37,5° for carbide inserts	495016
Toolholder 30° for carbide inserts	495015



ELECTRIC BEVELER 0/15-60/TUBE BEVELLING & DEBURRING MACHINE

- High torque AC induction motor offers long life and quiet running
- Adjustable milling angle from 0° and 15° to 60°
- Maximum land width 21 mm
- Tube beveling Ø 150 - 350 mm, with optional table plate Ø 300 up to Ø 600 mm
- Delivery with 12 carbide inserts and tool holder, table plate for beveling tubes Ø 150 - 350 mm and tools
- Change of inserts quick & easy - tool-free
- Precise bevel depth adjustment

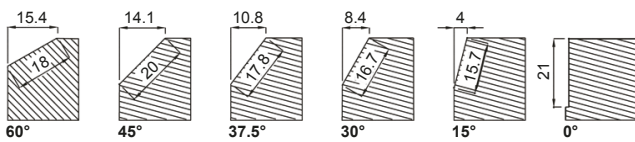

Ideal for weld seam preparation



Precise adjustment of bevel angle and height

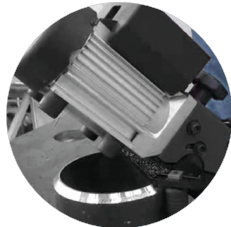

Tube beveling Ø 150 - 350 mm, with optional table plate Ø 300 up to Ø 600 mm



Delivery in carry case



12 carbide inserts and tool holder included, heavy duty construction



Optional: 12 carbide inserts Ref. 495030

Technical specifications	
Power input	1.100 W
Voltage	230 V / 50 Hz
Speeds	3.000 min ⁻¹
Beveling	60°: 18 mm, 45°: 20 mm 37,5°: 17,8 mm, 30°: 16,7 mm 15°: 15,7 mm, 0°: 21 mm
Dimensions	503 x 350 x 248 mm
Net weight	20,3 kg

Description	Reference
Delivery in carry case with 12 carbide inserts, tool holder, table plate for tube beveling Ø 150 - 350 mm and tools	495020N
Accessories (optional)	Reference
Base plate for tube beveling Ø 300 up to Ø 600 mm	495040
12 carbide inserts	495030



WRAPAROUND TUBE SANDER POLISHER 760/40



- Applicable for rough grinding up to mirror polishing
- High efficiency motor with variable fullwave feedback
- Electronic speed control with soft start
- High stable pulleys allow precise control of abrasive belts
- Tool-free change of abrasives
- The large wraparound angle allows easy and fast preparing and finishing of tube constructions (e.g. railings)



Perfect for the finishing of pipe constructions



Fits perfectly with up to 270 ° contact for all curves



Starter Pack
Ref. 495050

Accessories included

- 1: Carry case (572 x 362 x 238 mm)
- 2: Sandpaper belts
 - 80 (40 x 760 mm) 1 piece each
 - 100 (40 x 760 mm) 1 piece each
 - 120 (20 x 760 mm) 1 piece each
- 3: Surface conditioning belt (40 x 760 mm)

Technical Specifications

Power input	1.200 W
Voltage	230 V / 50 Hz
No load speed	1.600 - 3.200 min ⁻¹
Surface speed	3 - 12 m/s
Max. belt length	760 mm
Max. belt width	40 mm
Net weight	3,4 kg

Description

Delivery in hard carry case with accessories

Reference

495050

ACCESSORIES FOR

WRAPAROUND TUBE SANDER / POLISHER 760/40

HIGH PERFORMANCE ZIRCON ABRASIVE BELTS

Description

- Cotton/polyester backing with additive, aluminium oxide grain, double resin, close coat.

Main features and benefits

- Extremely long life and highly efficient removal. Coarser grits are suitable for heavy scrubbing of steel and cast iron. It is also suitable for wet applications.

Recommended applications

- grinding and cleaning, deburring, removing small protruding welded surfaces or welding spots.

Work surfaces

- Standard steel, stainless steel, non ferrous metals, cast iron, alloys.



Description as above	Packaging	Reference
Abrasive belts 40 x 760 mm - P080	10 pcs	495WS080
Abrasive belts 40 x 760 mm - P100	10 pcs	495WS100
Abrasive belts 40 x 760 mm - P120	10 pcs	495WS120

SURFACE CONDITIONING BELTS X-FLEX

This material is unique in the market . Its particular structure makes it very flexible and it prevents delamination. Ideal to work in narrow belts form and it is easy to fit on very compact machinery.

Description as above	Packaging	Reference
X-Flex - Brown 40 x 760 mm - coarse	20 pcs	495WS103
X-Flex - Red 40 x 760 mm - medium	20 pcs	495WS104
X-Flex - Blue 40 x 760 mm - very fine	20 pcs	495WS105



DRUM SANDER / POLISHER 100



- Applicable for rough grinding up to mirror polishing
- High efficiency motor with full-wave feedback
- Electronic speed control
- Inflatable rubber sanding drum conforms to the surface (pump included)

Can fit:

- Sanding sleeves in various grits
- Fine sanding sponge sleeves
- Surface conditioning (fleece) sleeves
- Tool-free arbor

Technical specifications

Power input	1.200 W
Voltage	230 V / 50 Hz
No load speed	1000 - 2.400 min ⁻¹
Max. wheel diameter	100 mm
Max. wheel width	100 mm
Arbor	Ø 19 mm x 100 mm mit Spindelarreterung
Net weight	4,8 kg

Description

Delivery in hard carry case with accessories

Reference

495080



Old metal surfaces look shiny and new



Starter Pack Ref. 495080



Surface conditioning flap wheel



Drive pulley for belts



Surface conditioning belts



Sandpaper belt

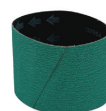

Sandpaper sleeves grit 80,100, 180 one piece each



Air pump



Inflatable rubber sanding drum



Hook & loop belt closing strap



Surface conditioning belts

ACCESSORIES FOR DRUM SANDER / POLISHER 100



SURFACE CONDITIONING SLEEVES FOR SATIN FINISH MACHINES

Recommended applications: Satin finishing and cleaning, finishing small and large surfaces. Removing scale or marks left by previous operations.

Work surfaces: stainless steel, standard or alloyed steel, non ferrous metals and alloys, aluminium, cast iron, titanium, plastic, wood.

Description	Packaging	Reference
SB 100 x 314 - coarse	5 pcs	495DP100
SB 100 x 314 - medium	5 pcs	495DP101
SB 100 x 314 - very fine	5 pcs	495DP102



HIGH PERFORMANCE ZIRCON SLEEVES FOR SATIN FINISHING MACHINES

Main features and benefits: Thanks to their wide abrasive area, they allow operators to rapidly and efficiently work on a wide range of surfaces. **Recommended applications:** light deburring, cleaning, finishing small and large surfaces. Removing scale or marks left by previous operations. **Work surfaces:** stainless steel, standard or alloyed steel, nonferrous metals and alloys, aluminium, cast iron, titanium, plastic, wood.

Description	Packaging	Reference
SB 100 x 314 - P080	10 pcs	495DP103
SB 100 x 314 - P100	10 pcs	495DP104
SB 100 x 314 - P120	10 pcs	495DP105



NONWOVEN WHEELS FOR SATIN FINISH MACHINES

Main features and benefits: These nonwoven wheels with a hole offer consistent finishing quality, highly efficient ventilation, flexibility, excellent user friendliness, low-noise levels and resistance to clogging. They can be cleaned using compressed air or water. The abrasive tool is efficiently driven by means of a unique 4-split-pin system and can be quickly fit. **Recommended applications:** Light deburring and cleaning. Satin finishing small and large surfaces. Removing scale. Removing marks left by previous operations and re-finishing after bending, welding or satin coil mounding. **Work surfaces:** Stainless steel, standard or alloyed steel, nonferrous metals and alloys, aluminium, cast iron, titanium, plastic.

Description	Packaging	Reference
SB 100 - coarse	4 pcs	495DP106
SB 100 - medium	4 pcs	495DP107
SB 100 - very fine	4 pcs	495DP108



INTERLEAF WHEELS FOR SATIN FINISH MACHINES

Main features and benefits: These wheels offer better cutting performances than nonwoven wheels whilst ensuring high finishing quality and excellent user friendliness combined with highly efficient ventilation and low-noise levels typical of nonwoven products. Thanks to a unique 4-split-spin, the abrasive tool can be efficiently driven and quickly fit. **Recommended applications:** Light deburring and cleaning. Satin finishing small and large surfaces. Removing scale. Removing marks left by previous operations. **Work surfaces:** Stainless steel, standard or alloyed steel, nonferrous metals and alloys, aluminium, cast iron, titanium.

Description	Packaging	Reference
SB 100 - coarse	4 pcs	495DP109
SB 100 - medium	4 pcs	495DP110
SB 100 - very fine	4 pcs	495DP111



Jepson Power GmbH
Ernst-Abbe-Straße 5
52249 Eschweiler
Germany

Phone
E-Mail
Website

+49 2403 64 55 0
info@jepson.de
www.drycutter.com