

HOSE REELS AND CABLE REELS

No. 223-AV



**ADVANCED FLUID
MANAGEMENT SOLUTIONS**





HELP THE ENVIRONMENT

Depending on the item, the packaging may contain one or more of the following materials - to be recycled according to local municipal or state regulations.

cardboard • polyethylene bag • polystyrene
paper • wood • nails • plastic straps
cellophane • paper clips • gummed paper

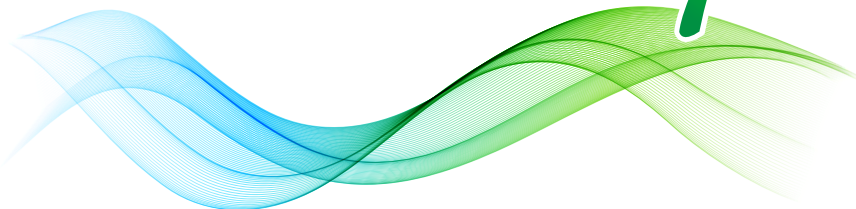



**ADVANCED FLUID
MANAGEMENT SOLUTIONS**



DESIGN IS

Art





founded in 1975



*the human side
of Quality*



CONCEPT, RESEARCH AND DESIGN

The real strength of a company lies in the ability of its concept and research departments to continuously find the solutions that best meet market demands.



ASSEMBLY LINES

Special equipment, expressly designed to facilitate assembly operations and which, at the same time, allows for effective, automatic quality control.

PACKAGING

The product is carefully packed with special cover to protect it from risks during transport.



COMPONENT STORAGE

Our vertical warehouses enable quick, precise preparation of components and spare parts for assembly and sale.



TECHNOLOGY
INNOVATION
QUALITY
SAFETY
RELIABILITY



**ADVANCED FLUID
MANAGEMENT SOLUTIONS**

TECHNICAL ASSISTANCE

RAASM has the most complete range of products for lubrication and fluid distribution. The goal is to always provide a comprehensive response to customer demands and fully meet their every need.





TO PREVENT:

✘ BREAKAGE

The hose reel protects the hose against wear and possible breakage.

✘ CLUTTER

With the hose reel, rewinding the hose is fast and safe, letting you keep the workplace tidy.

✘ ACCIDENTS

The hose reel allows workers to operate in full safety, the equipment always ready for use.

THE HOSE REEL



TO IMPROVE:

✓ EFFICIENCY

The hose reel cuts down on wasted time, letting you set the equipment where and when you need it, organising the workplace to meet your needs and keeping it clean and functional.

✓ FLEXIBILITY

Thanks to slotted holes and quick coupling supports, the hose reel assembly is safe and easy. Designed to be mounted on the wall - with narrow or wide arm - on the workbench, ceiling or HEA beam.

✓ HOSE LIFE

All components in the hose reel have been tested to last for decades, thus guaranteeing long-term savings and compliance with a conscious, farsseeing environmental protection policy.



HOW TO CHOOSE THE HOSE REEL

To choose the right hose reel, it is important to consider the following 4 characteristics. These must be stated when telephoning in your request to our sales-technical office.

1 What fluid will be used?

RAASM hose reels are compatible with any type of fluid. First check density, corrosiveness and flammability: we have hose reels that can handle any operating condition.

Below is a list of the main fluids that can be used.

Air	AdBlue®
Hot water	Oil-Water
High pressure water	Oil-Paints
Oil and similar	Welding
Grease	LPG
Diesel	Methane

2 What is the required operating pressure?

Knowing the operating pressure is a key element in choosing the correct model hose reel. Our product range can operate at pressures from 10 to 700 bar. Identify the pressure that best suits your needs depending on the type of fluid, application and size of the system used.

10 bar
20 bar
50 bar
70 bar
100 bar
150 bar
200 bar
400 bar
700 bar

3 What is the maximum hose length needed?

The wide range of models available lets you choose from lengths ranging from just a few metres to hundreds of metres long. This parameter is to be integrated with the choice of hose diameter.

4 What flow rate is required?

The diameter is very important as it determines the flow rate and the flow throughput. Together with length, this parameter limits the choice of the series of hose reel and determines the type of power supply.



HOW TO CUSTOMIZE THE HOSE REEL

The arms can easily be repositioned as needed to adapt the hose reel to the workplace. This operation is very simple and can be performed by the end user.

Standard installation

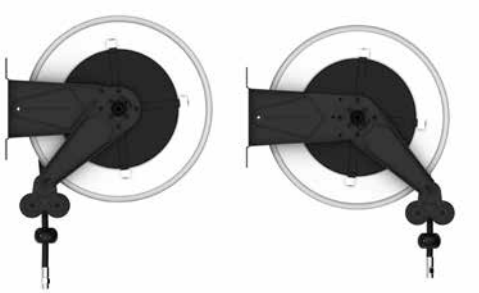

Floor or bench
installation

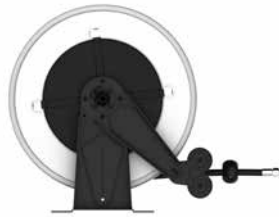

Ceiling installation



Depending on the material (ABS or painted steel), the drum can be customized with the following 4 colours. The brackets and arms will remain in the standard colour. To order an article in a colour other than the standard, the suffix indicated in the image below must be added to the code.

RAL 7035

RAL 1004

RAL 3020

RAL 5002

RAL 9005



standard



/C2



/C4



/C5



/R9005

The spring force can be customized according to the specific requirements of the application (ceiling installation, particularly heavy utilities etc.). By intervening on the bushing on the side of the drum and following the safety instructions given in the manual, the hose spring force can be easily increased or decreased.

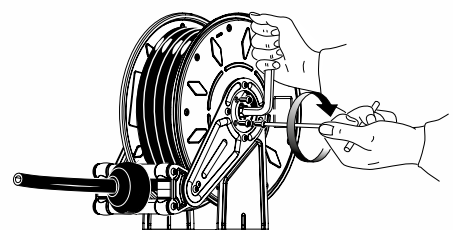
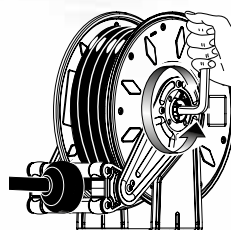
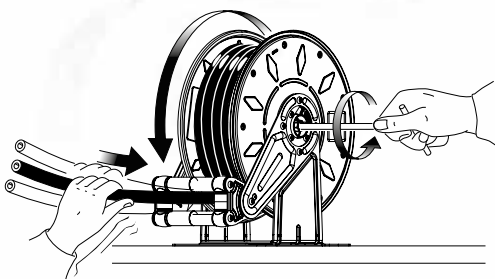

PRODUCT FAMILIES INDEX

page	painted		s. steel 304 - 316	
	page	ABS page	page	ABS page

SPRING OPERATED OPEN HOSE REELS

ADVANTAGES AND TECHNICAL CHARACTERISTICS	14	-	-	-	-
AIR-WATER 10-20 bar	-	18		20	
HOT WATER 50-100 bar	-	22		24	
HOT WATER 200 bar	-	26		28	
HOT WATER 400-700 bar	-	30	-	32	-
HOT WATER 100-200-400 bar in AISI 316	-	-	-	34	
OIL AND SIMILAR 50-100-150 bar	-	36		38	
GREASE 400-600 bar	-	40		42	
DIESEL 10-20 bar	-	44		46	-
ADBLUE® 10-100 bar	-	48		48	
LPG-METHANE 20 bar	-	50	-	-	-
WELDING 20 bar	-	52	-	-	-
DOUBLE INLET-OUTLET	-	54	-	-	-
ACCESSORIES	78	-	-	-	-



SPRING OPERATED ENCLOSED HOSE REELS

ADVANTAGES AND TECHNICAL CHARACTERISTICS	56	-	-	-	-
AIR-WATER 20 bar	-	60		-	-
OIL AND SIMILAR 150 bar	-	60		-	-
GREASE 400 - 600 bar	-	60		-	-
FOR SUCTION OF OIL AND SIMILAR	-	60	-	-	-
ACCESSORIES	78				



SPRING OPERATED HOSE REELS WITH POLYURETHANE HOSE

ADVANTAGES	62	-	-	-	-
TECHNICAL CHARACTERISTICS S. 250-288-328-378-438	64	-	-	-	-
AIR-WATER 20 bar	-	66		-	-
TECHNICAL CHARACTERISTICS CASING S. 260-280	68	-	-	-	-
AIR-WATER 20 bar	-	-	70	-	-
TECHNICAL CHARACTERISTICS CASING S. 250-300	72	-	-	-	-
AIR-WATER 20 bar	-	74	-	74	-
ACCESSORIES	78	-	-	-	-



page	painted		s. steel 304 - 316	
	page	ABS page	page	ABS page



MANUAL HOSE REELS

ADVANTAGES AND TECHNICAL CHARACTERISTICS	84	-	-	-	-
AIR-WATER 20 bar	-	92		94	
HOT WATER 70-100-200-400 bar	-	96		98	
OIL AND SIMILAR 150 bar	-	100		102	
GREASE 600 bar	-	104		106	
DIESEL 20 bar	-	108		110	
ACCESSORIES	120	-	-	-	-



MANUAL TROLLEY-MOUNTED HOSE REEL

ADVANTAGES AND TECHNICAL CHARACTERISTICS	112	-	-	-	-
AIR-WATER 20 bar	-	116	-	120	-
HOT WATER 100 bar	-	116	-	120	-
HOT WATER 200 bar	-	116	-	120	-
HOT WATER 400 bar	-	116	-	120	-
ACCESSORIES	120	-	-	-	-



MOTORIZED HOSE REELS

ADVANTAGES AND TECHNICAL CHARACTERISTICS	122	-	-	-	-
AIR-WATER 20 bar	-	126	-	-	-
HOT WATER 70-100 bar	-	128	-	130	-
OIL AND SIMILAR 70-150 bar	-	132	-	-	-
GREASE 400 bar	-	134	-	-	-
DIESEL 20 bar	-	136	-	-	-
ACCESSORIES	138	-	-	-	-

HOSES, STOPS AND FITTINGS

	139	-	-	-	-
--	-----	---	---	---	---

SPRING OPERATED ELECTRIC CABLE REELS



ADVANTAGES AND TECHNICAL CHARACTERISTICS	146	-	-	-	-
S. 280 EXTENSION CORD - 230 V SINGLE PHASE	150	-	-	-	-
S. 280 EXTENSION CORD - 400 V THREE PHASE	152	-	-	-	-
S. 280 EXTENSION CORD WITH SCHUKO PLUG AND SOCKET - 230 V SINGLE PHASE	154	-	-	-	-
S. 280 EXTENSION CORD WITHOUT TRANSFORMER FLUORESCENT LAMP - 230 V SINGLE PHASE	158	-	-	-	-
S. 280 EXTENSION CORD WITHOUT TRANSFORMER LED LAMP - FROM 12 V TO 24 V AC/DC	160	-	-	-	-
S. 280 EXTENSION CORD WITH LED LAMP WITH TRANSFORMER - 230 V AC/DC	162	-	-	-	-
FLUORESCENT AND LED LAMP	164	-	-	-	-
EARTHING CABLE REELS	166	-	-	-	-

ARTICLES INDEX

	170
--	-----



**ADVANCED FLUID
MANAGEMENT SOLUTIONS**

SPRING OPERATED OPEN HOSE REELS



EXAMPLES OF **USE**

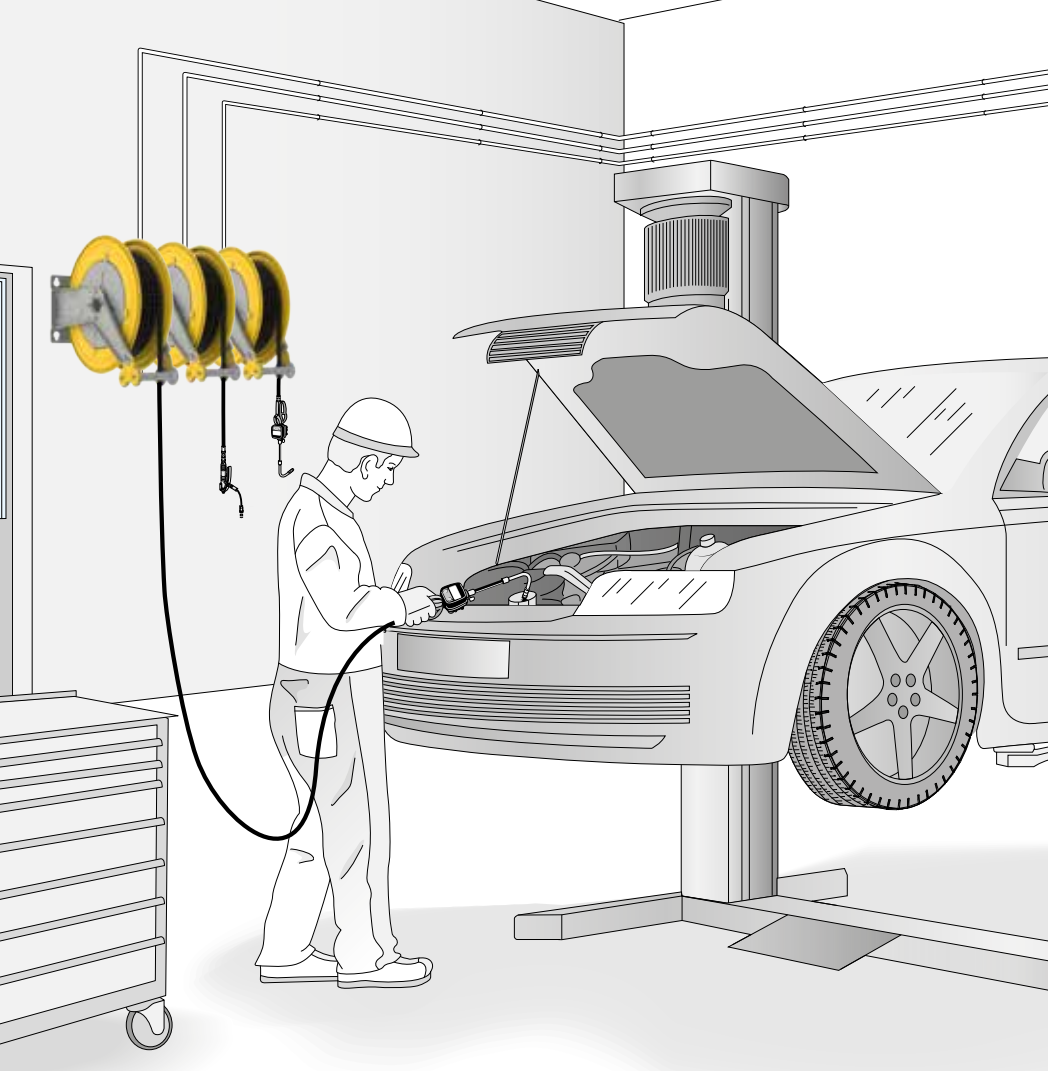

IN-SHOP MAINTENANCE OPERATION

HYGIENIC AND SANITARY WASHING OPERATIONS



AUTOMOTIVE

LUBE
TRUCKS AND
INDUSTRIAL
VEHICLES

CLEANING

CHEMICAL
INDUSTRY

BUILDING
AND ROAD
CONSTRUCTION

...and much more



**ADVANCED FLUID
MANAGEMENT SOLUTIONS**

SPRING OPERATED OPEN HOSE REELS



STRENGTH POINTS

- Repeated spring stress-tests guarantees decades of life and efficiency.
- All models comply with the ATEX directive for use in environments with potentially explosive atmospheres.
- Hose stop available for all standard models, even those supplied without hose.
- The spring force is both constant and adjustable. Thus use can be fine-tuned to the specific needs of each application.
- All sliding parts, such as bushing and the rack, are made of special technopolymers tested for long-term use.
- Compatible with many types of fluids, even highly corrosive fluids.

TECHNICAL CHARACTERISTICS

Visit our
website



FIXING BRACKET

Has 4 slotted holes for safe, easy installation.

PAWL

Easy to remove for maintenance or when the work requires free sliding.

STOP RACK

Makes it possible to lock the hose around every 0,5 m.

SPRING

Tested to withstand over 20000 work cycles.

MULTI POSITION ARMS

Hose outlet position can be changed manually by modifying installation of the arms.

HOSE GUIDE

Designed with ample width and roller arrangement to reduce wear on the hose.

SWIVEL JOINT

Designed to minimise load losses. Available in different materials to ensure maximum chemical compatibility with a wide range of fluids.

CENTRAL PIN

Designed to minimise load losses. Available in different materials to ensure maximum chemical compatibility with a wide range of fluids.

DRUM SUPPORT BUSHING

Made of self-lubricating technopolymer with excellent wear and corrosion resistance.

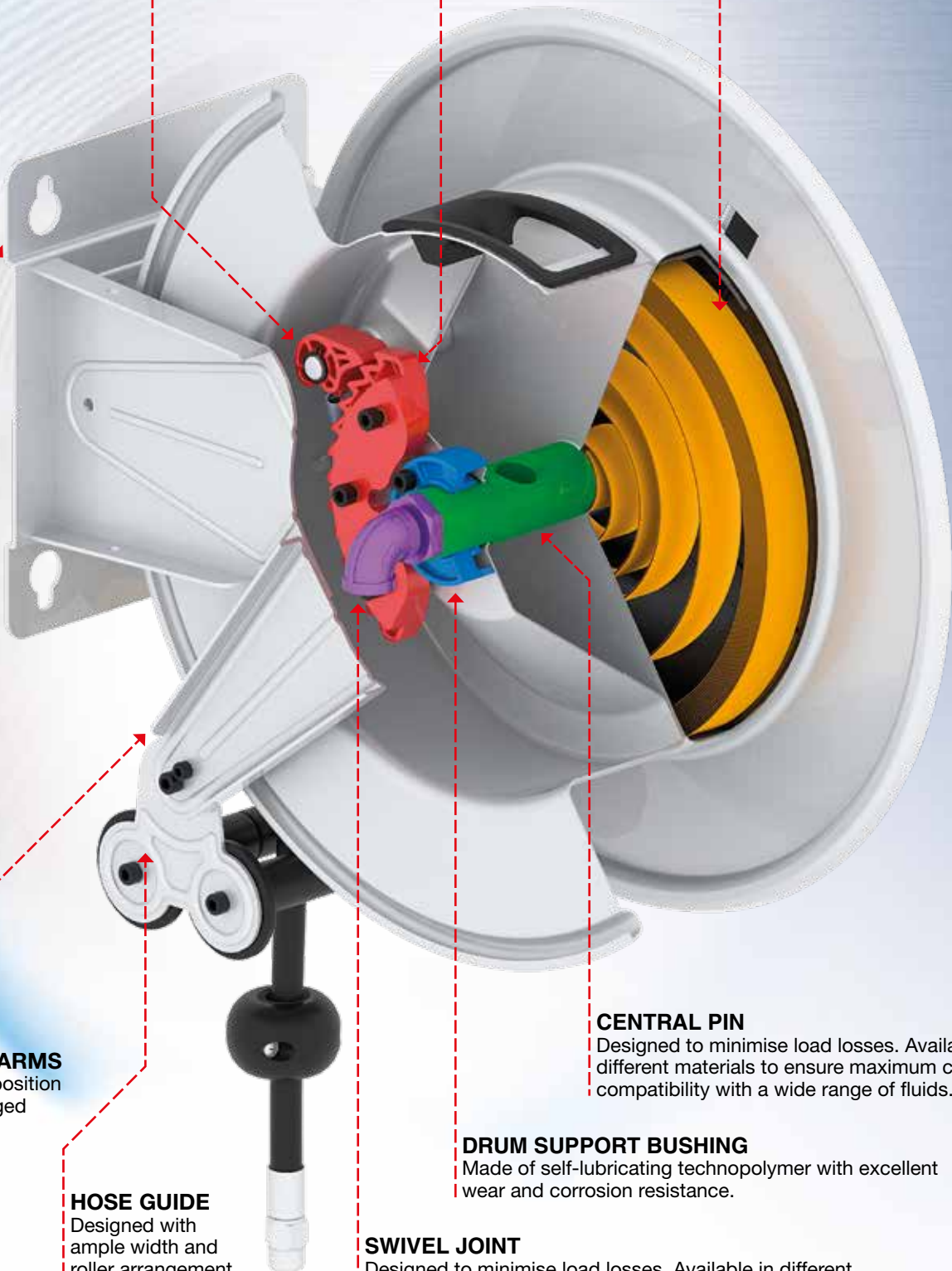



Type of fluid
AIR-WATER

Pressure
20 bar

Material
- PAINTED STEEL
- ABS

WITH SPRING



FIXED*



SWIVELLING

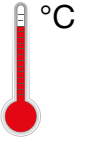

- with hose, see page 139
- without hose, max. 100 °C



In accordance with directive







* can be rendered swivelling by using the special bracket, see page 81.

DRUM COLOURS

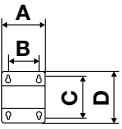
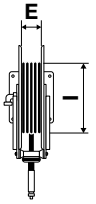
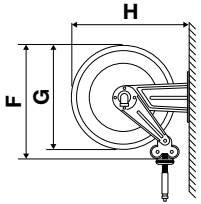
Painted
ABS

Hoses	Connections	Seals	Swivel joint	Central pin
black rubber	galvanized steel	Viton®	brass	galvanized steel
				

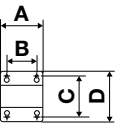
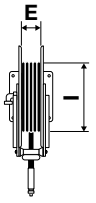
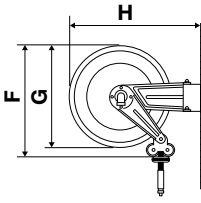
Overall dimensions FIXED (mm)			Series	A	B	C	D	E	F	G	H	I	Packaging (mm) W x D x H	
			290	186	140	196	226	98	330	300	339	135		
			330	186	140	196	226	98	390	350	365	155		470 x 260 x 490
			390	186	140	196	226	98	410	390	410	155		510 x 260 x 520
			430	186	140	197	226	97	450	415	456	264		580 x 280 x 590
			430 ABS	186	140	197	226	110	450	425	461	259		580 x 280 x 590
			530	203	153	221	258	104	535	510	558	315		650 x 290 x 700
			540	300	218	227	268	165	535	510	572	315		660 x 390 x 690
			560	488	399	238	272	348	535	510	578	315		670 x 610 x 760

Overall dimensions SWIVELLING (mm)			Series	A	B	C	D	E	F	G	H	I	Packaging (mm) W x D x H	
			390	184	146	106	144	98	410	390	482	155		
			430	208	162	118	164	97	450	415	540	264		580 x 280 x 590
			530	228	182	154	200	104	535	510	642	315		650 x 290 x 700
			540	300	218	227	268	165	535	510	700	315		660 x 390 x 690

(W: width - D: depth - H: height)



	P/N		Hose supplied	Connection		Weight	
	fixed	swivelling		inlet	outlet	fixed	swivelling
s. 290	8290.100	-	without hose *	G 3/8" (f)	G 3/8" (f)	10,0 kg	-
	8290.101	-	10 m - 3/8" (995.210)	G 3/8" (f)	G 3/8" (m)	12,0 kg	-
	8290.104	-	15 m - 1/4" (993.215)	G 3/8" (f)	G 1/4" (m)	12,0 kg	-
* Hose reel capacity		inner hose Ø max. length	1/4" 16 m	5/16" 14 m	3/8" 10 m		
s. 330	8330.100	-	without hose *	G 3/8" (f)	G 3/8" (f)	11,2 kg	-
	8330.101	-	12 m - 3/8" (995.211)	G 3/8" (f)	G 3/8" (m)	13,5 kg	-
* Hose reel capacity		inner hose Ø max. length	1/4" 18 m	5/16" 16 m	3/8" 14 m	1/2" 12 m	
s. 390	8390.100	8380.100	without hose *	G 3/8" (f)	G 3/8" (f)	13,0 kg	13,5 kg
	8390.102	8380.102	18 m - 3/8" (995.217)	G 3/8" (f)	G 3/8" (m)	16,0 kg	16,5 kg
* Hose reel capacity		inner hose Ø max. length	1/4" 20 m	5/16" 20 m	3/8" 18 m	1/2" 15 m	
s. 430	8430.100	8420.100	without hose *	G 1/2" (f)	G 1/2" (f)	16,0 kg	16,5 kg
	8430.101	8420.101	12 m - 3/8" (995.212)	G 1/2" (f)	G 3/8" (m)	18,7 kg	19,2 kg
	8430.102	8420.102	18 m - 3/8" (995.218)	G 1/2" (f)	G 3/8" (m)	19,5 kg	20,0 kg
	8430.103	8420.103	10 m - 1/2" (996.210)	G 1/2" (f)	G 1/2" (m)	19,2 kg	19,7 kg
	8430.104	8420.104	15 m - 1/2" (996.215)	G 1/2" (f)	G 1/2" (m)	20,2 kg	20,7 kg
	8430.150	-	without hose **	G 1" (f)	G 3/4" (f)	17,0 kg	-
Hose reel capacity		inner hose Ø max. length	* 5/16" 20 m	3/8" 20 m	1/2" 16 m	** 5/8" 14 m	3/4" 8 m
s. 430 ABS	9430.100	-	without hose *	G 1/2" (f)	G 1/2" (f)	12,5 kg	-
	9430.101	-	12 m - 3/8" (995.212)	G 1/2" (f)	G 3/8" (m)	15,2 kg	-
	9430.102	-	18 m - 3/8" (995.218)	G 1/2" (f)	G 3/8" (m)	16,0 kg	-
	9430.103	-	10 m - 1/2" (996.210)	G 1/2" (f)	G 1/2" (m)	15,7 kg	-
	9430.104	-	15 m - 1/2" (996.215)	G 1/2" (f)	G 1/2" (m)	16,7 kg	-
* Hose reel capacity		inner hose Ø max. length	5/16" 20 m	3/8" 20 m	1/2" 15 m	5/8" 14 m	
s. 530	8530.100	8520.100	without hose *	G 1/2" (f)	G 1/2" (f)	21,0 kg	22,0 kg
	8530.101	8520.101	20 m - 1/2" (996.220)	G 1/2" (f)	G 1/2" (m)	26,5 kg	27,5 kg
	8530.102	8520.102	25 m - 1/2" (996.225)	G 1/2" (f)	G 1/2" (m)	27,3 kg	28,3 kg
	8530.150	-	without hose **	G 1" (f)	G 1" (f)	22,0 kg	-
Hose reel capacity		inner hose Ø max. length	* 3/8" 25 m	1/2" 25 m	5/8" 22 m	** 3/4" 12 m	1" 8 m
s. 540	8540.100	8550.100	without hose *	G 1" (f)	G 1" (f)	28,0 kg	33,5 kg
	8540.101	8550.101	15 m - 3/4" (997.215)	G 1" (f)	G 3/4" (m)	35,0 kg	40,5 kg
	8540.102	8550.102	20 m - 3/4" (997.220)	G 1" (f)	G 3/4" (m)	36,5 kg	42,0 kg
	8540.103	8550.103	15 m - 1" (998.215)	G 1" (f)	G 1" (m)	38,6 kg	44,1 kg
	8540.105	8550.105	without hose **	G 1/2" (f)	G 1/2" (f)	28,5 kg	34,0 kg
	8540.106	8550.106	30 m - 1/2" (996.230)	G 1/2" (f)	G 1/2" (m)	36,4 kg	41,9 kg
Hose reel capacity		inner hose Ø max. length	* 5/8" 20 m	3/4" 20 m	1" 15 m	** 3/8" 30 m	1/2" 30 m
s. 560	8560.100	-	without hose *	G 1" (f)	G 1" (f)	48,0 kg	-
	8560.101	-	30 m - 3/4" (997.230)	G 1" (f)	G 3/4" (m)	60,0 kg	-
	8560.103	-	40 m - 3/4" (997.240)	G 1" (f)	G 3/4" (m)	63,0 kg	-
	8560.104	-	20 m - 1" (998.220)	G 1" (f)	G 1" (m)	60,6 kg	-
	8560.105	-	30 m - 1" (998.230)	G 1" (f)	G 1" (m)	64,0 kg	-
	8560.106	-	without hose **	G 1/2" (f)	G 1/2" (f)	47,5 kg	-
Hose reel capacity		inner hose Ø max. length	* 5/8" 50 m	3/4" 40 m	1" 30 m	** 3/8" 60 m	1/2" 60 m
						5/8" 60 m	



Type of fluid
AIR-WATER

Pressure
10-20 bar

Material
**- AISI 304 S. STEEL
- ABS**

WITH SPRING



FIXED*

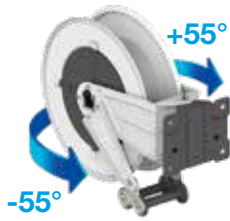

SWIVELLING

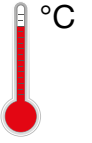

- with hose, see page 139
- without hose, max. 100 °C

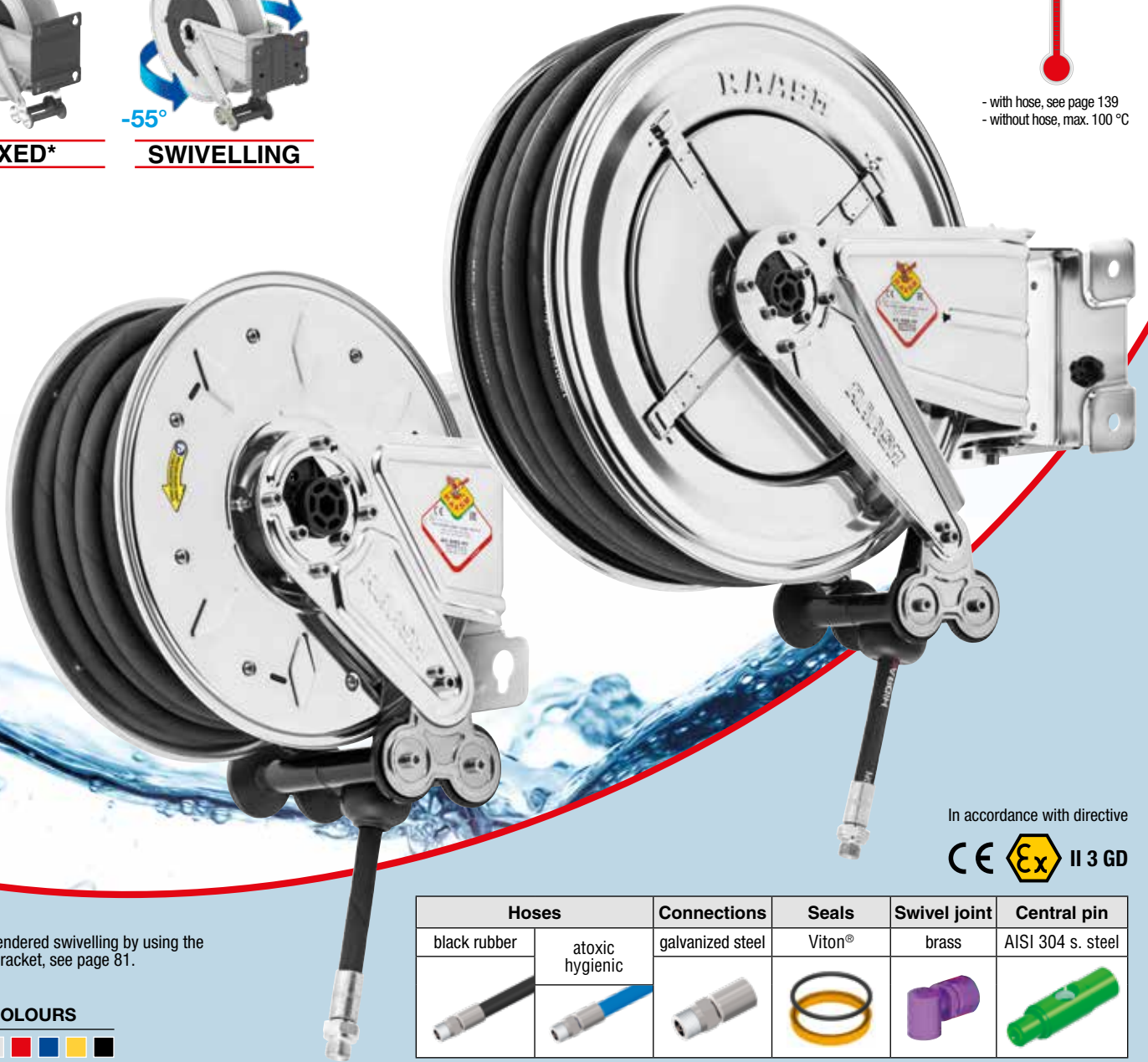

In accordance with directive







* can be rendered swivelling by using the special bracket, see page 81.

DRUM COLOURS

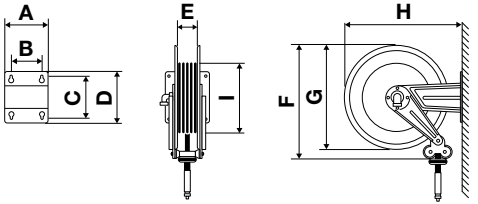
ABS

Hoses		Connections	Seals	Swivel joint	Central pin
black rubber	atoxic hygienic	galvanized steel	Viton®	brass	AISI 304 s. steel
					

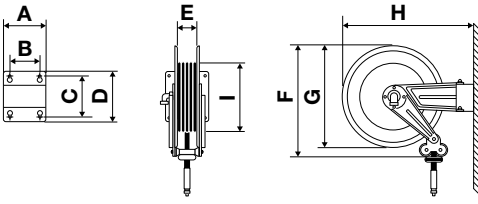
Overall dimensions FIXED (mm)		Series	A	B	C	D	E	F	G	H	I	Packaging (mm) W x D x H
		290	186	140	196	226	98	330	300	339	135	 470 x 260 x 490 510 x 260 x 520 580 x 280 x 590 580 x 280 x 590 580 x 280 x 590 650 x 290 x 700 660 x 390 x 690 670 x 610 x 760
		330	186	140	196	226	98	390	350	365	155	
		390	186	140	196	226	98	410	390	410	155	
		430	186	140	197	226	97	450	415	456	264	
		430 ABS	186	140	197	226	110	450	425	461	259	
		530	203	153	221	258	104	535	510	558	315	
		540	300	218	227	268	165	535	510	572	315	
	560	488	399	238	272	348	535	510	578	315		

Overall dimensions SWIVELLING (mm)		Series	A	B	C	D	E	F	G	H	I	Packaging (mm) W x D x H
		390	184	146	106	144	98	410	390	482	155	 580 x 280 x 590 580 x 280 x 590 650 x 290 x 700 660 x 390 x 690
		430	208	162	118	164	97	450	415	540	264	
		530	228	182	154	200	104	535	510	642	315	
		540	300	218	227	268	165	535	510	700	315	

(W: width - D: depth - H: height)



	P/N		Hose supplied	Connection		Weight		
	fixed	swivelling		inlet	outlet	fixed	swivelling	
s. 290 20 bar	8292.100	-	without hose *	G 3/8" (f)	G 3/8" (f)	10,0 kg	-	
	8292.101	-	10 m - 3/8" (995.210)	G 3/8" (f)	G 3/8" (m)	12,0 kg	-	
	8292.104	-	15 m - 1/4" (993.215)	G 3/8" (f)	G 1/4" (m)	12,0 kg	-	
* Hose reel capacity		inner hose Ø max. length	1/4" 5/16" 3/8"	16 m 14 m 10 m				
s. 330 20 bar	8332.100	-	without hose *	G 3/8" (f)	G 3/8" (f)	11,2 kg	-	
	8332.101	-	12 m - 3/8" (995.211)	G 3/8" (f)	G 3/8" (m)	13,5 kg	-	
	8333.101	-	12 m - 3/8" (995.112)	G 3/8" (f)	G 3/8" (m)	13,4 kg	-	
* Hose reel capacity		inner hose Ø max. length	1/4" 5/16" 3/8" 1/2"	18 m 16 m 14 m 12 m				
s. 390 20 bar	8392.100	8382.100	without hose *	G 3/8" (f)	G 3/8" (f)	13,0 kg	13,5 kg	
	8392.102	8382.102	18 m - 3/8" (995.217)	G 3/8" (f)	G 3/8" (m)	16,0 kg	16,5 kg	
* Hose reel capacity		inner hose Ø max. length	1/4" 5/16" 3/8" 1/2"	20 m 20 m 18 m 15 m				
s. 430 20 bar	8432.100	8422.100	without hose *	G 1/2" (f)	G 1/2" (f)	16,0 kg	16,5 kg	
	8432.101	8422.101	12 m - 3/8" (995.212)	G 1/2" (f)	G 3/8" (m)	18,7 kg	19,2 kg	
	8432.102	8422.102	18 m - 3/8" (995.218)	G 1/2" (f)	G 3/8" (m)	19,5 kg	20,0 kg	
	8432.103	8422.103	10 m - 1/2" (996.210)	G 1/2" (f)	G 1/2" (m)	19,2 kg	19,7 kg	
	8432.104	8422.104	15 m - 1/2" (996.215)	G 1/2" (f)	G 1/2" (m)	20,2 kg	20,7 kg	
	8432.150	-	without hose **	G 1" (f)	G 3/4" (f)	17,0 kg	-	
10 bar	8433.102	-	15 m - 1/2" (996.116)	G 1/2" (f)	G 1/2" (m)	19,2 kg	-	
Hose reel capacity		inner hose Ø max. length	* 5/16" 3/8" 1/2"	20 m 20 m 16 m	** 5/8" 3/4"	14 m 8 m		
s. 430 20 bar ABS	9432.100	-	without hose *	G 1/2" (f)	G 1/2" (f)	12,5 kg	-	
	9432.101	-	12 m - 3/8" (995.212)	G 1/2" (f)	G 3/8" (m)	15,2 kg	-	
	9432.102	-	18 m - 3/8" (995.218)	G 1/2" (f)	G 3/8" (m)	16,0 kg	-	
	9432.103	-	10 m - 1/2" (996.210)	G 1/2" (f)	G 1/2" (m)	15,7 kg	-	
	9432.104	-	15 m - 1/2" (996.215)	G 1/2" (f)	G 1/2" (m)	16,7 kg	-	
10 bar	9433.102	-	15 m - 1/2" (996.116)	G 1/2" (f)	G 1/2" (m)	15,5 kg	-	
* Hose reel capacity		inner hose Ø max. length	5/16" 3/8" 1/2"	20 m 20 m 16 m				
s. 530 20 bar	8532.100	8522.100	without hose *	G 1/2" (f)	G 1/2" (f)	21,0 kg	22,0 kg	
	8532.101	8522.101	20 m - 1/2" (996.220)	G 1/2" (f)	G 1/2" (m)	26,5 kg	27,5 kg	
	8532.102	8522.102	25 m - 1/2" (996.225)	G 1/2" (f)	G 1/2" (m)	27,3 kg	28,3 kg	
	8532.150	-	without hose **	G 1" (f)	G 1" (f)	22,0 kg	-	
10 bar	8533.102	-	25 m - 1/2" (996.125)	G 1/2" (f)	G 1/2" (m)	27,1 kg	-	
Hose reel capacity		inner hose Ø max. length	* 3/8" 1/2" 5/8"	25 m 25 m 22 m	** 3/4" 1"	12 m 8 m		
s. 540 20 bar	8542.100	8552.100	without hose *	G 1" (f)	G 1" (f)	28,0 kg	33,5 kg	
	8542.101	8552.101	15 m - 3/4" (997.215)	G 1" (f)	G 3/4" (m)	35,0 kg	40,5 kg	
	8542.102	8552.102	20 m - 3/4" (997.220)	G 1" (f)	G 3/4" (m)	36,5 kg	42,0 kg	
	8542.103	8552.103	15 m - 1" (998.215)	G 1" (f)	G 1" (m)	38,6 kg	44,1 kg	
	8542.105	8552.105	without hose **	G 1/2" (f)	G 1/2" (f)	28,5 kg	34,0 kg	
	8542.106	8552.106	30 m - 1/2" (996.230)	G 1/2" (f)	G 1/2" (m)	36,4 kg	41,9 kg	
s. 540 10 bar	8543.102	-	20 m - 3/4" (997.120)	G 1" (f)	G 3/4" (m)	36,5 kg	-	
	8543.103	-	15 m - 1" (998.115)	G 1" (f)	G 1" (m)	38,0 kg	-	
	8543.106	-	30 m - 1/2" (996.130)	G 1/2" (f)	G 1/2" (m)	36,5 kg	-	
Hose reel capacity		inner hose Ø max. length	* 5/8" 3/4" 1"	20 m 22 m 15 m	** 3/8" 1/2" 5/8"	30 m 30 m 30 m		
s. 560 20 bar	8562.100	-	without hose *	G 1" (f)	G 1" (f)	48,0 kg	-	
	8562.101	-	30 m - 3/4" (997.230)	G 1" (f)	G 3/4" (m)	60,0 kg	-	
	8562.103	-	40 m - 3/4" (997.240)	G 1" (f)	G 3/4" (m)	63,0 kg	-	
	8562.104	-	20 m - 1" (998.220)	G 1" (f)	G 1" (m)	60,6 kg	-	
	8562.105	-	30 m - 1" (998.230)	G 1" (f)	G 1" (m)	64,0 kg	-	
	8562.106	-	without hose **	G 1/2" (f)	G 1/2" (f)	47,5 kg	-	
10 bar	8563.103	-	40 m - 3/4" (997.140)	G 1" (f)	G 3/4" (m)	63,5 kg	-	
	8563.105	-	30 m - 1" (998.130)	G 1" (f)	G 1" (m)	64,5 kg	-	
Hose reel capacity		inner hose Ø max. length	* 5/8" 3/4" 1"	50 m 40 m 30 m	** 3/8" 1/2" 5/8"	60 m 60 m 60 m		

Atoxic hygienic hose

Black rubber hose



Type of fluid
HOT WATER

Pressure
50-100 bar

Material
- PAINTED STEEL
- ABS

WITH SPRING



FIXED*



SWIVELLING

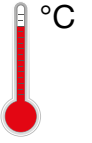

- with hose, see page 139
- without hose, max. 130 °C



In accordance with directive



for ABS versions

* can be rendered swivelling by using the special bracket, see page 81.

DRUM COLOURS

Painted ABS

Hoses		Connections	Seals	Swivel joint	Central pin
black rubber	hygienic	galvanized steel	Viton®	AISI 304 s. steel	galvanized steel

Overall dimensions FIXED (mm)											Series	A	B	C	D	E	F	G	H	I	Packaging (mm) W x D x H		
						W		D x H															
											330	186	140	196	226	98	390	350	365	155		510 x 260 x 520	
											390	186	140	196	226	98	410	390	410	155		580 x 280 x 590	
											430	186	140	197	226	97	450	415	456	264		580 x 280 x 590	
											430 ABS	186	140	197	226	110	450	425	461	259		580 x 280 x 590	
											530	203	153	221	258	104	535	510	558	315		650 x 290 x 700	
											540	300	218	227	268	165	535	510	572	315		660 x 390 x 690	
											560	488	399	238	272	348	535	510	578	315	670 x 610 x 760		

Overall dimensions SWIVELLING (mm)											Series	A	B	C	D	E	F	G	H	I	Packaging (mm) W x D x H		
						W		D x H															
											390	184	146	106	144	98	410	390	482	155		580 x 280 x 590	
											430	208	162	118	164	97	450	415	540	264		580 x 280 x 590	
											530	228	182	154	200	104	535	510	642	315		650 x 290 x 700	
											540	300	218	227	268	165	535	510	700	315		660 x 390 x 690	

(W: width - D: depth - H: height)



P/N		Hose supplied	Connection		Weight	
fixed	swivelling		inlet	outlet	fixed	swivelling

s. 330 100 bar	8330.200	-	without hose *		G 1/2" (f)	G 3/8"(f) G 1/2"(f)	11,2 kg	-
	8330.201	-	12 m - 3/8" (995.313)		G 1/2" (f)	G 3/8" (m)	15,7 kg	-

* Hose reel capacity	inner hose Ø	1/4"	5/16"	3/8"	1/2"
	max. length	12 m	12 m	12 m	8 m

s. 390 100 bar	8390.200	8380.200	without hose *		G 1/2" (f)	G 3/8"(f) G 1/2"(f)	13,0 kg	14,0 kg
	8390.202	8380.202	17 m - 3/8" (995.318)		G 1/2" (f)	G 3/8" (m)	19,0 kg	20,0 kg

* Hose reel capacity	inner hose Ø	1/4"	5/16"	3/8"	1/2"
	max. length	15 m	16 m	17 m	12 m

s. 430 100 bar	8430.200	8420.200	without hose *		G 1/2" (f)	G 1/2" (f)	16,0 kg	17,2 kg
	8430.201	8420.201	10 m - 1/2" (996.311)		G 1/2" (f)	G 1/2" (m)	20,7 kg	22,2 kg
	8430.202	8420.202	15 m - 1/2" (996.316)		G 1/2" (f)	G 1/2" (m)	22,1 kg	23,5 kg
	8430.250	-	without hose **		G 1" (f)	G 3/4" (f)	17,0 kg	-

Hose reel capacity	inner hose Ø	* 5/16"		3/8"	1/2"	** 5/8"		3/4"
	max. length	20 m		20 m	16 m	14 m		8 m

s. 430 ABS 100 bar	9430.200	-	without hose *		G 1/2" (f)	G 1/2" (f)	12,5 kg	-
	9430.201	-	10 m - 1/2" (996.311)		G 1/2" (f)	G 1/2" (m)	17,3 kg	-
	9430.202	-	15 m - 1/2" (996.316)		G 1/2" (f)	G 1/2" (m)	18,7 kg	-
	9431.202	-	15 m - 1/2" (996.415)		G 1/2" (f)	G 1/2" (m)	20,0 kg	-

* Hose reel capacity	inner hose Ø	5/16"	3/8"	1/2"
	max. length	20 m	20 m	16 m

s. 530 100 bar	8530.200	8520.200	without hose *		G 1/2" (f)	G 1/2" (f)	21,0 kg	22,0 kg
	8530.201	8520.201	20 m - 1/2" (996.321)		G 1/2" (f)	G 1/2" (m)	30,0 kg	31,0 kg

* Hose reel capacity	inner hose Ø	3/8"	1/2"	5/8"
	max. length	25 m	25 m	22 m

s. 540 100 bar	8540.200	8550.200	without hose *		G 1" (f)	G 1" (f)	28,0 kg	33,5 kg
	8540.202	8550.202	20 m - 3/4" (997.320)		G 1" (f)	G 3/4" (m)	40,7 kg	46,2 kg

s. 540 50 bar	8540.203	8550.203	15 m - 1" (998.315)		G 1" (f)	G 1" (m)	42,0 kg	47,5 kg
-------------------------	-----------------	-----------------	---------------------	--	----------	----------	---------	---------

* Hose reel capacity	inner hose Ø	5/8"	3/4"	1"
	max. length	20 m	22 m	15 m

s. 560 100 bar	8560.200	-	without hose *		G 1" (f)	G 1" (f)	48,0 kg	-
--------------------------	-----------------	---	----------------	--	----------	----------	---------	---

s. 560 50 bar	8560.205	-	30 m - 1" (998.330)		G 1" (f)	G 1" (m)	78,2 kg	-
-------------------------	-----------------	---	---------------------	--	----------	----------	---------	---

* Hose reel capacity	inner hose Ø	5/8"	3/4"	1"
	max. length	50 m	40 m	30 m

 Hygienic hose

 Black rubber hose



Type of fluid
HOT WATER

Pressure
50-100 bar

Material
- AISI 304 S. STEEL
- ABS

WITH SPRING



FIXED*

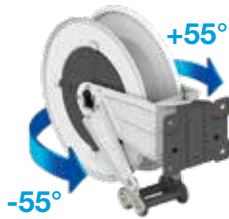

SWIVELLING

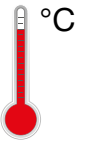

- with hose, see page 139
- without hose, max. 130 °C



In accordance with directive



for ABS versions

* can be rendered swivelling by using the special bracket, see page 81.

DRUM COLOURS

ABS

Hoses		Connections	Seals	Swivel joint	Central pin
black rubber	hygienic	galvanized steel	Viton®	AISI304 s. steel	AISI 304 s. steel

Overall dimensions FIXED (mm)		Series	A	B	C	D	E	F	G	H	I	Packaging (mm) W x D x H	
		330	186	140	196	226	98	390	350	365	155		510 x 260 x 520
		390	186	140	196	226	98	410	390	410	155		580 x 280 x 590
		430	186	140	197	226	97	450	415	456	264		580 x 280 x 590
		430 ABS	186	140	197	226	110	450	425	461	259		580 x 280 x 590
		530	203	153	221	258	104	535	510	558	315		650 x 290 x 700
		540	300	218	227	268	165	535	510	572	315		660 x 390 x 690
		560	488	399	238	272	348	535	510	578	315		670 x 610 x 760

Overall dimensions SWIVELLING (mm)		Series	A	B	C	D	E	F	G	H	I	Packaging (mm) W x D x H	
		390	184	146	106	144	98	410	390	482	155		580 x 280 x 590
		430	208	162	118	164	97	450	415	540	264		580 x 280 x 590
		530	228	182	154	200	104	535	510	642	315		650 x 290 x 700
		540	300	218	227	268	165	535	510	700	315		660 x 390 x 690

(W: width - D: depth - H: height)



	P/N		Hose supplied	Connection		Weight	
	fixed	swivelling		inlet	outlet	fixed	swivelling
s. 330 100 bar	8332.400	-	without hose *	G 1/2" (f)	G 3/8"(f) G 1/2"(f)	11,2 kg	-
	8332.201	-	12 m - 3/8" (995.313)	G 1/2" (f)	G 3/8" (m)	15,7 kg	-
	8333.202	-	12 m - 3/8" (995.412)	G 1/2" (f)	G 3/8" (m)	15,7 kg	-

* Hose reel capacity	inner hose Ø	1/4"	5/16"	3/8"	1/2"		
	max. length	12 m	12 m	12 m	11 m		



s. 390 100 bar	8392.200	8382.200	without hose *	G 1/2" (f)	G 3/8"(f) G 1/2"(f)	13,0 kg	13,5 kg
	8392.202	8382.202	17 m - 3/8" (995.318)	G 1/2" (f)	G 3/8" (m)	19,0 kg	19,5 kg
	8393.201	8383.201	12 m - 3/8" (995.412)	G 1/2" (f)	G 3/8" (m)	17,5 kg	18,0 kg

* Hose reel capacity	inner hose Ø	1/4"	5/16"	3/8"	1/2"		
	max. length	15 m	16 m	17 m	12 m		



s. 430 100 bar	8434.200	8424.200	without hose *	G 1/2" (f)	G 1/2" (f)	16,0 kg	16,5 kg
	8434.250	-	without hose **	G 1" (f)	G 3/4" (f)	17,0 kg	-
	8432.201	8422.201	10 m - 1/2" (996.311)	G 1/2" (f)	G 1/2" (m)	20,7 kg	21,2 kg
	8432.202	8422.202	15 m - 1/2" (996.316)	G 1/2" (f)	G 1/2" (m)	22,1 kg	22,6 kg
	8433.202	8423.202	15 m - 1/2" (996.415)	G 1/2" (f)	G 1/2" (m)	22,1 kg	22,6 kg

Hose reel capacity	inner hose Ø	* 5/16"	3/8"	1/2"	** 5/8"	3/4"	
	max. length	20 m	20 m	16 m	14 m	8 m	



s. 430 ABS 100 bar	9434.200	-	without hose *	G 1/2" (f)	G 1/2" (f)	12,5 kg	-
	9432.201	-	10 m - 1/2" (996.311)	G 1/2" (f)	G 1/2" (m)	17,3 kg	-
	9432.202	-	15 m - 1/2" (996.316)	G 1/2" (f)	G 1/2" (m)	18,7 kg	-
	9433.202	-	15 m - 1/2" (996.415)	G 1/2" (f)	G 1/2" (m)	20,0 kg	-

* Hose reel capacity	inner hose Ø	5/16"	3/8"	1/2"			
	max. length	20 m	20 m	16 m			



s. 530 100 bar	8534.200	8524.200	without hose *	G 1/2" (f)	G 1/2" (f)	21,0 kg	22,0 kg
	8532.201	8522.201	20 m - 1/2" (996.321)	G 1/2" (f)	G 1/2" (m)	30,0 kg	31,0 kg
	8534.250	-	without hose **	G 1" (f)	G 1" (f)	22,5 kg	-
	8533.202	8523.202	25 m - 1/2" (996.425)	G 1/2" (f)	G 1/2" (m)	32,0 kg	33,0 kg

Hose reel capacity	inner hose Ø	* 3/8"	1/2"	5/8"	** 3/4"	1"	
	max. length	25 m	25 m	22 m	12 m	8 m	



s. 540 100 bar	8544.200	8554.200	without hose *	G 1" (f)	G 1" (f)	28,0 kg	33,5 kg
	8542.202	8552.202	20 m - 3/4" (997.320)	G 1" (f)	G 3/4" (m)	40,7 kg	46,2 kg
	8544.205	8554.205	without hose **	G 1/2" (f)	G 1/2" (f)	28,5 kg	34,0 kg
	8543.202	8553.202	20 m - 3/4" (997.420)	G 1" (f)	G 3/4" (m)	40,7 kg	46,2 kg

s. 540 50 bar	8542.203	8552.203	15 m - 1" (998.315)	G 1" (f)	G 1" (m)	42,0 kg	47,5 kg
-------------------------	-----------------	-----------------	---------------------	----------	----------	---------	---------

Hose reel capacity	inner hose Ø	* 5/8"	3/4"	1"	** 3/8"	1/2"	5/8"
	max. length	20 m	22 m	15 m	30 m	30 m	30 m



s. 560 100 bar	8564.200	-	without hose *	G 1" (f)	G 1" (f)	48,0 kg	-
	8564.206	-	without hose **	G 1/2" (f)	G 1/2" (f)	47,5 kg	-
s. 560 50 bar	8562.205	-	30 m - 1" (998.330)	G 1" (f)	G 1" (m)	78,2 kg	-

Hose reel capacity	inner hose Ø	* 5/8"	3/4"	1"	** 3/8"	1/2"	5/8"
	max. length	50 m	40 m	30 m	60 m	60 m	60 m

 Hygienic hose

 Black rubber hose



Type of fluid
HOT WATER

Pressure
200 bar

Material
- PAINTED STEEL
- ABS

WITH SPRING



FIXED*



SWIVELLING

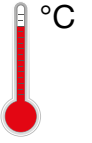

- with hose, see page 139
- without hose, max. 130 °C

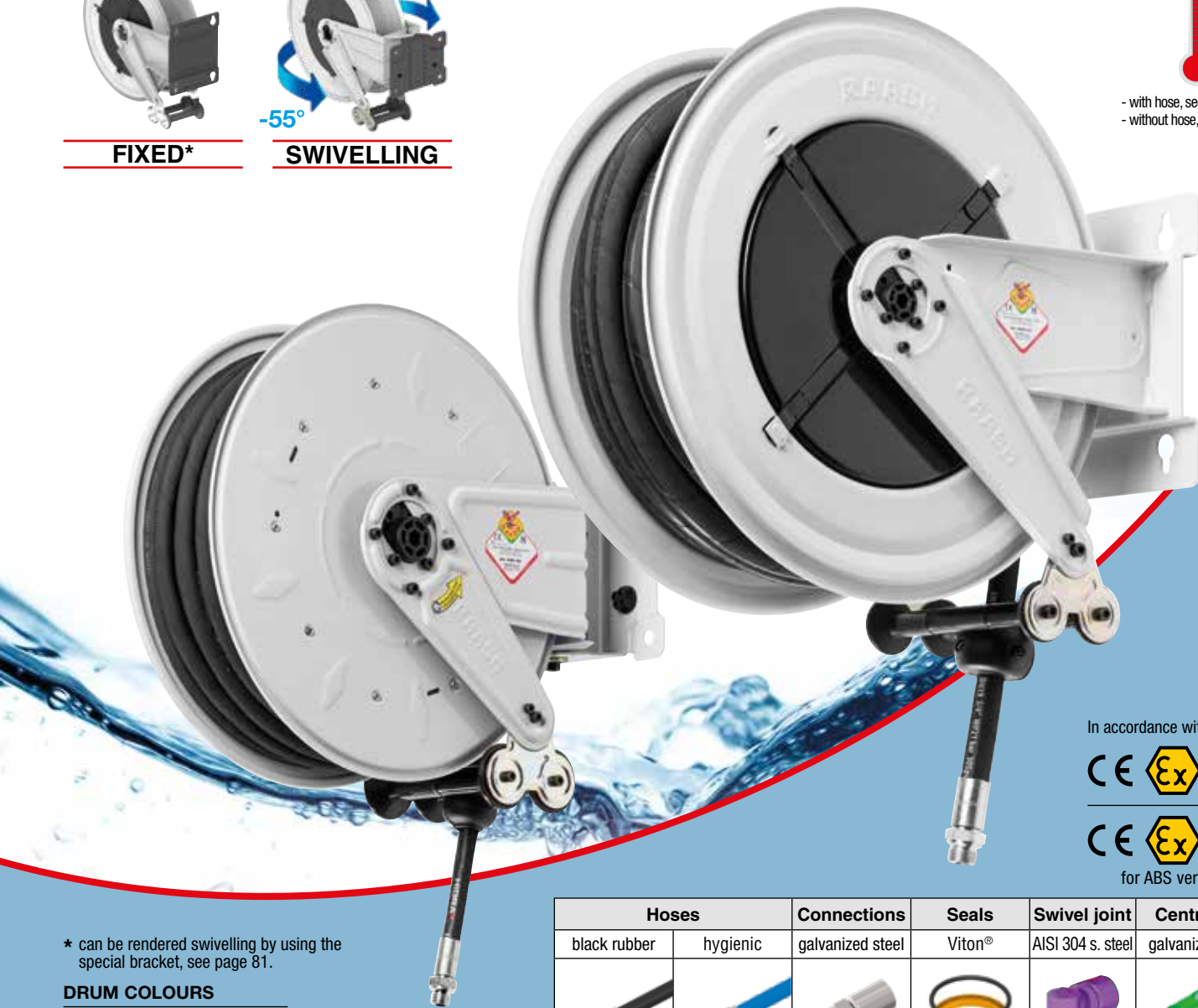

In accordance with directive



for ABS versions

* can be rendered swivelling by using the special bracket, see page 81.

DRUM COLOURS

Painted ABS

Hoses		Connections	Seals	Swivel joint	Central pin
black rubber	hygienic	galvanized steel	Viton®	AISI 304 s. steel	galvanized steel

Overall dimensions FIXED (mm)											Series	A	B	C	D	E	F	G	H	I	Packaging (mm) W x D x H				
330	186	140	196	226	98	390	350	365	155																510 x 260 x 520
390	186	140	196	226	98	410	390	410	155																580 x 280 x 590
430	186	140	197	226	97	450	415	456	264																580 x 280 x 590
430 ABS	186	140	197	226	110	450	425	461	259																580 x 280 x 590
530	203	153	221	258	104	535	510	558	315																650 x 290 x 700
540	300	218	227	268	165	535	510	572	315																660 x 390 x 690
560	488	399	238	272	348	535	510	578	315																670 x 610 x 760

Overall dimensions SWIVELLING (mm)											Series	A	B	C	D	E	F	G	H	I	Packaging (mm) W x D x H				
390	184	146	106	144	98	410	390	482	155																580 x 280 x 590
430	208	162	118	164	97	450	415	540	264																580 x 280 x 590
530	228	182	154	200	104	535	510	642	315																650 x 290 x 700
540	300	218	227	268	165	535	510	700	315																660 x 390 x 690

(W: width - D: depth - H: height)



P/N		Hose supplied	Connection		Weight	
fixed	swivelling		inlet	outlet	fixed	swivelling

s. 330	8330.300	-	without hose *	G 3/8" (f)	G 3/8" (f)	11,2 kg	-
	8330.301	-	12 m - 5/16" (994.512)	G 3/8" (f)	G 3/8" (f)	14,8 kg	-

* Hose reel capacity	inner hose Ø	1/4"	5/16"	3/8"	1/2"
	max. length	12 m	12 m	12 m	8 m

s. 390	8390.300	8380.300	without hose *	G 3/8" (f)	G 3/8" (f)	13,0 kg	13,5 kg
	8390.302	8380.302	17 m - 5/16" (994.517)	G 3/8" (f)	G 3/8" (f)	17,0 kg	17,5 kg

* Hose reel capacity	inner hose Ø	1/4"	5/16"	3/8"	1/2"
	max. length	15 m	16 m	17 m	12 m

s. 430	8430.300	8420.300	without hose *	G 3/8" (f)	G 1/2" (f)	16,0 kg	16,5 kg
	8430.301	8420.301	12 m - 3/8" (995.512)	G 3/8" (f)	G 3/8" (f)	20,3 kg	20,8 kg
	8430.302	8420.302	18 m - 3/8" (995.518)	G 3/8" (f)	G 3/8" (f)	22,4 kg	22,9 kg

* Hose reel capacity	inner hose Ø	5/16"	3/8"	1/2"
	max. length	20 m	20 m	16 m

s. 430 ABS	9430.300	-	without hose *	G 3/8" (f)	G 1/2" (f)	12,5 kg	-
	9430.301	-	12 m - 3/8" (995.512)	G 3/8" (f)	G 3/8" (f)	16,8 kg	-
	9430.302	-	18 m - 3/8" (995.518)	G 3/8" (f)	G 3/8" (f)	18,8 kg	-
	9431.302	-	18 m - 3/8" (995.618)	G 3/8" (f)	G 3/8" (f)	19,0 kg	-

* Hose reel capacity	inner hose Ø	5/16"	3/8"	1/2"
	max. length	20 m	20 m	16 m

s. 530	8530.300	8520.300	without hose *	G 3/8" (f)	G 1/2" (f)	21,0 kg	22,0 kg
	8530.301	8520.301	20 m - 3/8" (995.520)	G 3/8" (f)	G 3/8" (f)	27,0 kg	28,0 kg
	8530.302	8520.302	25 m - 3/8" (995.525)	G 3/8" (f)	G 3/8" (f)	28,5 kg	29,5 kg

* Hose reel capacity	inner hose Ø	3/8"	1/2"	5/8"
	max. length	25 m	25 m	22 m

s. 540	8540.300	8550.300	without hose *	G 3/8" (f)	G 1/2" (f)	28,0 kg	33,5 kg
	8540.301	8550.301	30 m - 3/8" (995.530)	G 3/8" (f)	G 3/8" (f)	36,8 kg	42,3 kg

* Hose reel capacity	inner hose Ø	3/8"	1/2"	5/8"
	max. length	30 m	30 m	30 m

s. 560	8560.300	-	without hose *	G 3/8" (f)	G 1/2" (f)	48,0 kg	-
	8560.301	-	40 m - 3/8" (995.540)	G 3/8" (f)	G 3/8" (f)	59,0 kg	-
	8560.302	-	50 m - 3/8" (995.550)	G 3/8" (f)	G 3/8" (f)	64,8 kg	-

* Hose reel capacity	inner hose Ø	3/8"	1/2"	5/8"
	max. length	60 m	60 m	60 m

 Hygienic hose

 Black rubber hose



Type of fluid
HOT WATER

Pressure
200 bar

Material
- AISI 304 S. STEEL
- ABS

WITH SPRING



FIXED*



SWIVELLING

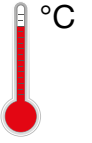

- with hose, see page 139
- without hose, max. 130 °C

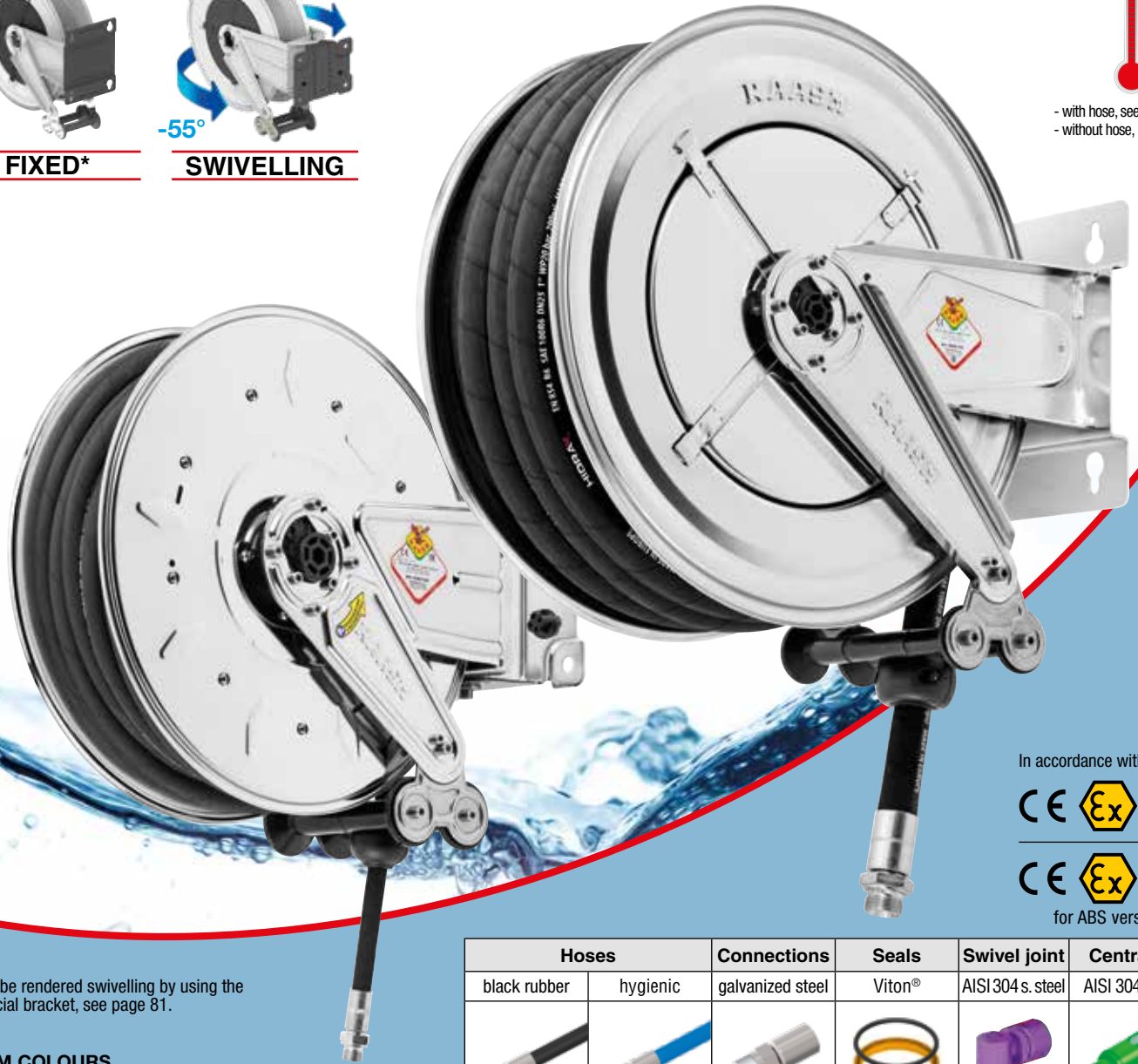

In accordance with directive





for ABS versions



* can be rendered swivelling by using the special bracket, see page 81.

DRUM COLOURS

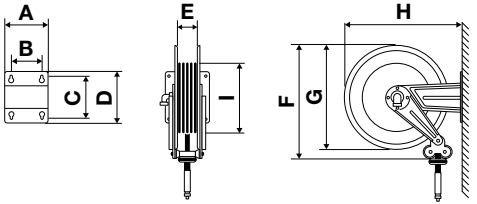
ABS

Hoses		Connections	Seals	Swivel joint	Central pin
black rubber	hygienic	galvanized steel	Viton®	AISI 304 s. steel	AISI 304 s. steel
					

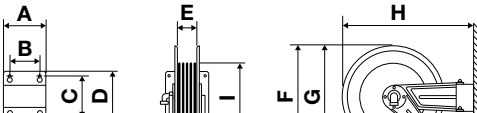
Overall dimensions FIXED (mm)		Series	A	B	C	D	E	F	G	H	I	Packaging (mm) W x D x H	
		330	186	140	196	226	98	390	350	365	155		510 x 260 x 520
		390	186	140	196	226	98	410	390	410	155		580 x 280 x 590
		430	186	140	197	226	97	450	415	456	264		580 x 280 x 590
		430 ABS	186	140	197	226	110	450	425	461	259		580 x 280 x 590
		530	203	153	221	258	104	535	510	558	315		650 x 290 x 700
		540	300	218	227	268	165	535	510	572	315		660 x 390 x 690
		560	488	399	238	272	348	535	510	578	315		670 x 610 x 760

Overall dimensions SWIVELLING (mm)		Series	A	B	C	D	E	F	G	H	I	Packaging (mm) W x D x H	
		390	184	146	106	144	98	410	390	482	155		580 x 280 x 590
		430	208	162	118	164	97	450	415	540	264		580 x 280 x 590
		530	228	182	154	200	104	535	510	642	315		650 x 290 x 700
		540	300	218	227	268	165	535	510	700	315		660 x 390 x 690

(W: width - D: depth - H: height)



	P/N		Hose supplied	Connection		Weight	
	fixed	swivelling		inlet	outlet	fixed	swivelling
s. 330	8332.300	-	without hose *	G 3/8" (f)	G 3/8" (f)	11,2 kg	-
	8332.301	-	12 m - 5/16" (994.512)	G 3/8" (f)	G 3/8" (f)	14,8 kg	-
	8333.301	-	12 m - 5/16" (994.612)	G 3/8" (f)	G 3/8" (f)	14,8 kg	-

* Hose reel capacity	inner hose Ø	1/4"	5/16"	3/8"	1/2"		
	max. length	12 m	12 m	12 m	8 m		



s. 390	8392.300	8382.300	without hose *	G 3/8" (f)	G 3/8" (f)	13,0 kg	13,5 kg
	8392.302	8382.302	17 m - 5/16" (994.517)	G 3/8" (f)	G 3/8" (f)	17,0 kg	17,5 kg
	8393.301	8383.301	12 m - 5/16" (994.612)	G 3/8" (f)	G 3/8" (f)	16,6 kg	17,1 kg

* Hose reel capacity	inner hose Ø	1/4"	5/16"	3/8"	1/2"		
	max. length	15 m	16 m	17 m	12 m		



s. 430	8434.300	8424.300	without hose *	G 3/8" (f)	G 1/2" (f)	16,0 kg	16,5 kg
	8432.301	8422.301	12 m - 3/8" (995.512)	G 3/8" (f)	G 3/8" (f)	20,3 kg	20,8 kg
	8432.302	8422.302	18 m - 3/8" (995.518)	G 3/8" (f)	G 3/8" (f)	22,4 kg	22,9 kg
	8433.302	8423.302	18 m - 3/8" (995.618)	G 3/8" (f)	G 3/8" (f)	22,4 kg	22,9 kg

* Hose reel capacity	inner hose Ø	5/16"	3/8"	1/2"			
	max. length	20 m	20 m	16 m			



s. 430 ABS	9434.300	-	without hose *	G 3/8" (f)	G 1/2" (f)	12,5 kg	-
	9432.301	-	12 m - 3/8" (995.512)	G 3/8" (f)	G 3/8" (f)	16,8 kg	-
	9432.302	-	18 m - 3/8" (995.518)	G 3/8" (f)	G 3/8" (f)	18,8 kg	-
	9433.302	-	18 m - 3/8" (995.618)	G 3/8" (f)	G 3/8" (f)	19,0 kg	-

* Hose reel capacity	inner hose Ø	5/16"	3/8"	1/2"			
	max. length	20 m	20 m	16 m			



s. 530	8534.300	8524.300	without hose *	G 3/8" (f)	G 1/2" (f)	21,0 kg	22,0 kg
	8532.301	8522.301	20 m - 3/8" (995.520)	G 3/8" (f)	G 3/8" (f)	27,0 kg	28,0 kg
	8532.302	8522.302	25 m - 3/8" (995.525)	G 3/8" (f)	G 3/8" (f)	28,5 kg	29,5 kg
	8533.302	8523.302	25 m - 3/8" (995.625)	G 3/8" (f)	G 3/8" (f)	28,5 kg	29,5 kg

* Hose reel capacity	inner hose Ø	3/8"	1/2"	5/8"			
	max. length	25 m	25 m	22 m			



s. 540	8544.300	8554.300	without hose *	G 3/8" (f)	G 1/2" (f)	28,5 kg	34,0 kg
	8542.301	8552.301	30 m - 3/8" (995.530)	G 3/8" (f)	G 3/8" (f)	36,8 kg	42,3 kg
	8543.301	8553.301	30 m - 3/8" (995.630)	G 3/8" (f)	G 3/8" (f)	36,8 kg	42,3 kg

* Hose reel capacity	inner hose Ø	3/8"	1/2"	5/8"			
	max. length	30 m	30 m	30 m			



s. 560	8564.300	-	without hose *	G 3/8" (f)	G 1/2" (f)	47,5 kg	-
	8562.301	-	40 m - 3/8" (995.540)	G 3/8" (f)	G 3/8" (f)	59,0 kg	-
	8562.302	-	50 m - 3/8" (995.550)	G 3/8" (f)	G 3/8" (f)	64,8 kg	-

* Hose reel capacity	inner hose Ø	3/8"	1/2"	5/8"			
	max. length	60 m	60 m	60 m			

Hygienic hose

Black rubber hose



Type of fluid
HOT WATER

Pressure
400 bar

Material
PAINTED STEEL

WITH SPRING



FIXED*

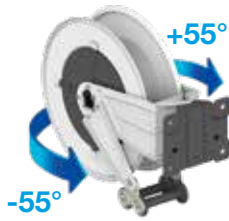

SWIVELLING

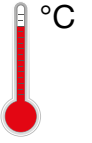

- with hose, see page 139
- without hose, max. 130 °C



In accordance with directive





* can be rendered swivelling by using the special bracket, see page 81.

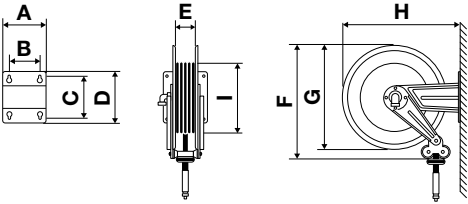

DRUM COLOURS

Painted

Hoses	Connections	Seals	Swivel joint	Central pin
black rubber	galvanized steel	Viton® - Teflon®	AISI 304 s. steel	galvanized steel
				

Overall dimensions FIXED (mm)			Series	A	B	C	D	E	F	G	H	I	Packaging (mm) W x D x H	
	330	186	140	196	226	98	390	350	365	155		510 x 260 x 520		
	390	186	140	196	226	98	410	390	410	155		580 x 280 x 590		
	430	186	140	197	226	97	450	415	456	264		580 x 280 x 590		
	530	203	153	221	258	104	535	510	558	315		650 x 290 x 700		
	540	300	218	227	268	165	535	510	572	315		660 x 390 x 690		
	560	488	399	238	272	348	535	510	578	315		670 x 610 x 760		

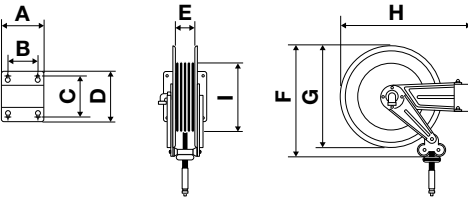
(W: width - D: depth - H: height)

Overall dimensions SWIVELLING (mm)			Series	A	B	C	D	E	F	G	H	I	Packaging (mm) W x D x H	
	390	184	146	106	144	98	410	390	482	155		580 x 280 x 590		
	430	208	162	118	164	97	450	415	540	264		580 x 280 x 590		
	530	228	182	154	200	104	535	510	642	315		650 x 290 x 700		
	540	300	218	227	268	165	535	510	700	315		660 x 390 x 690		

(W: width - D: depth - H: height)



	P/N		Hose supplied	Connection		Weight	
	fixed	swivelling		inlet	outlet	fixed	swivelling
s. 330	8330.350	-	without hose *	G 3/8" (f)	G 3/8" (f)	11,2 kg	-
* Hose reel capacity	inner hose Ø		1/4"	5/16"	3/8"	1/2"	
	max. length		12 m	12 m	12 m	8 m	
s. 390	8390.350	8380.350	without hose *	G 3/8" (f)	G 3/8" (f)	13,0 kg	13,5 kg
	8390.352	8380.352	17 m - 5/16" (994.717)	G 3/8" (f)	G 3/8" (f)	20,7 kg	21,2 kg
* Hose reel capacity	inner hose Ø		1/4"	5/16"	3/8"	1/2"	
	max. length		15 m	16 m	17 m	12 m	
s. 430	8430.350	8420.350	without hose *	G 3/8" (f)	G 1/2" (f)	16,0 kg	16,5 kg
	8430.354	8420.354	15 m - 3/8" (995.815)	G 3/8" (f)	G 3/8" (f)	23,1 kg	23,6 kg
* Hose reel capacity	inner hose Ø		5/16"	3/8"			
	max. length		12 m	15 m			
s. 530	8530.350	8520.350	without hose *	G 3/8" (f)	G 1/2" (f)	21,0 kg	22,0 kg
	8530.352	8520.352	25 m - 3/8" (995.825)	G 3/8" (f)	G 3/8" (f)	31,8 kg	32,8 kg
* Hose reel capacity	inner hose Ø		3/8"	1/2"			
	max. length		25 m	25 m			
s. 540	8540.350	8550.350	without hose *	G 3/8" (f)	G 1/2" (f)	28,0 kg	33,5 kg
* Hose reel capacity	inner hose Ø		3/8"	1/2"			
	max. length		30 m	30 m			
s. 560	8560.350	-	without hose *	G 3/8" (f)	G 1/2" (f)	48,0 kg	-
* Hose reel capacity	inner hose Ø		3/8"	1/2"			
	max. length		60 m	60 m			



Type of fluid
HOT WATER

Pressure
400-700 bar

Material
**- AISI 304 S. STEEL
- ABS**

WITH SPRING



FIXED*

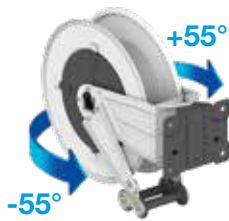

SWIVELLING

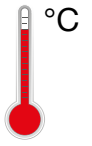

- with hose, see page 139
- without hose, max. 130 °C



In accordance with directive





for ABS versions



* can be rendered swivelling by using the special bracket, see page 81.

DRUM COLOURS

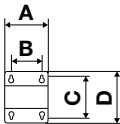
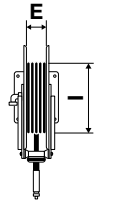
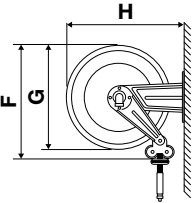
ABS

Hoses		Connections	Seals	Swivel joint	Central pin
black rubber	hygienic	galvanized steel	Viton® - Teflon®	AISI 304 s. steel	AISI 304 s. steel
					

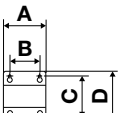
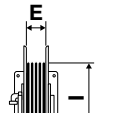
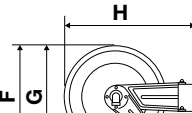
Overall dimensions FIXED (mm)			Series	A	B	C	D	E	F	G	H	I	Packaging (mm) W x D x H	
			330	186	140	196	226	98	390	350	365	155		510 x 260 x 520
			390	186	140	196	226	98	410	390	410	155		580 x 280 x 590
			430	186	140	197	226	97	450	415	456	264		580 x 280 x 590
			430 ABS	186	140	197	226	110	450	425	461	259		580 x 280 x 590
			530	203	153	221	258	104	535	510	558	315		650 x 290 x 700
			540	300	218	227	268	165	535	510	572	315		660 x 390 x 690
			560	488	399	238	272	348	535	510	578	315		670 x 610 x 760

Overall dimensions SWIVELLING (mm)			Series	A	B	C	D	E	F	G	H	I	Packaging (mm) W x D x H	
			390	184	146	106	144	98	410	390	482	155		580 x 280 x 590
			430	208	162	118	164	97	450	415	540	264		580 x 280 x 590
			530	228	182	154	200	104	535	510	642	315		650 x 290 x 700
			540	300	218	227	268	165	535	510	700	315		660 x 390 x 690

(W: width - D: depth - H: height)

P/N		Hose supplied	Connection		Weight	
fixed	swivelling		inlet	outlet	fixed	swivelling



s. 330 400 bar	8332.350	-	without hose *	G 3/8" (f)	G 3/8" (f)	11,2 kg	-
--------------------------	-----------------	---	----------------	------------	------------	---------	---

* Hose reel capacity	inner hose Ø	1/4"	5/16"	3/8"	1/2"
	max. length	12 m	12 m	12 m	8 m



s. 390 400 bar	8392.350	8382.350	without hose *	G 3/8" (f)	G 3/8" (f)	13,0 kg	13,5 kg
	8392.352	8382.352	17 m - 5/16" (994.717)	G 3/8" (f)	G 3/8" (f)	20,7 kg	21,2 kg

* Hose reel capacity	inner hose Ø	1/4"	5/16"	3/8"	1/2"
	max. length	15 m	16 m	17 m	12 m



s. 430 400 bar	8434.350	8424.350	without hose *	G 3/8" (f)	G 1/2" (f)	16,0 kg	16,5 kg
	8432.354	8422.354	15 m - 3/8" (995.815)	G 3/8" (f)	G 3/8" (f)	23,1 kg	23,6 kg
	8433.354	8423.354	15 m - 3/8" (995.915)	G 3/8" (f)	G 3/8" (f)	23,1 kg	23,6 kg

* Hose reel capacity	inner hose Ø	5/16"	3/8"
	max. length	12 m	15 m



s. 430 ABS 400 bar	9434.350	-	without hose *	G 3/8" (f)	G 1/2" (f)	12,5 kg	-
	9432.353	-	10 m - 3/8" (995.810)	G 3/8" (f)	G 3/8" (f)	18,4 kg	-
	9432.354	-	15 m - 3/8" (995.815)	G 3/8" (f)	G 3/8" (f)	20,8 kg	-

* Hose reel capacity	inner hose Ø	5/16"	3/8"
	max. length	12 m	15 m



s. 530 400 bar	8534.350	8524.350	without hose *	G 3/8" (f)	G 1/2" (f)	21,0 kg	22,0 kg
	8532.352	8522.352	25 m - 3/8" (995.825)	G 3/8" (f)	G 3/8" (f)	31,8 kg	32,8 kg
	8533.352	8523.352	25 m - 3/8" (995.925)	G 3/8" (f)	G 3/8" (f)	31,8 kg	32,8 kg

s. 530 700 bar	8534.550	-	without hose *	G 3/8" (f)	G 3/8" (f)	21,0 kg	-
--------------------------	-----------------	---	----------------	------------	------------	---------	---

* Hose reel capacity	inner hose Ø	3/8"	1/2"
	max. length	25 m	25 m



s. 540 400 bar	8544.350	8554.350	without hose *	G 3/8" (f)	G 1/2" (f)	28,0 kg	33,5 kg
s. 540 700 bar	8544.550	-	without hose *	G 3/8" (f)	G 3/8" (f)	28,5 kg	-

* Hose reel capacity	inner hose Ø	3/8"	1/2"
	max. length	30 m	30 m



s. 560 400 bar	8564.350	-	without hose *	G 3/8" (f)	G 1/2" (f)	48,0 kg	-
--------------------------	-----------------	---	----------------	------------	------------	---------	---

* Hose reel capacity	inner hose Ø	3/8"	1/2"
	max. length	60 m	60 m

 Hygienic hose  Black rubber hose



Type of fluid
HOT WATER

Pressure
**100-200
400 bar**

Material
AISI 316 S. STEEL

WITH SPRING



FIXED*

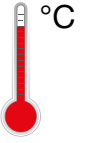

- with hose, see page 139
- without hose, max. 130 °C



* can be rendered swivelling by using the special bracket, see page 81.



In accordance with directive



The hose reels in AISI 316 stainless steel can also be used for the following fluids:

OIL AND SIMILAR GREASE DIESEL ADBLUE®

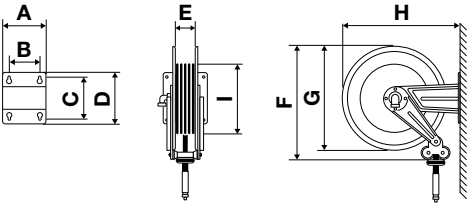
Seals	Swivel joint	Central pin
Viton®-Teflon®	AISI 316 s. steel	AISI 316 s. steel
		

Overall dimensions (mm)			Series	A	B	C	D	E	F	G	H	I	Packaging (mm) W x D x H
			430	186	140	197	226	97	450	415	456	264	 580 x 280 x 590
			530	203	153	221	258	104	535	510	558	315	650 x 290 x 700
			540	300	218	227	268	165	535	510	572	315	660 x 390 x 690
			560	488	399	238	272	348	535	510	578	315	670 x 610 x 760

(W: width - D: depth - H: height)

See specific catalogue



P/N	Hose supplied	Connection		Weight
		inlet	outlet	



s. 430 100 bar	8435.200	without hose *	G 1/2" (f)	G 1/2" (f)	16,0 kg
s. 430 200 bar	8435.300	without hose *	G 3/8" (f)	G 1/2" (f)	16,0 kg
s. 430 400 bar	8435.350	without hose **	G 3/8" (f)	G 1/2" (f)	16,0 kg

* Hose reel capacity	inner hose Ø	5/16"	3/8"	1/2"
	max. length	20 m	20 m	16 m
** Hose reel capacity	inner hose Ø	5/16"	3/8"	
	max. length	12 m	15 m	



s. 530 100 bar	8535.200	without hose *	G 1/2" (f)	G 1/2" (f)	21,0 kg
s. 530 200 bar	8535.300	without hose *	G 3/8" (f)	G 1/2" (f)	21,0 kg
s. 530 400 bar	8535.350	without hose **	G 3/8" (f)	G 1/2" (f)	21,0 kg

* Hose reel capacity	inner hose Ø	3/8"	1/2"	5/8"
	max. length	25 m	25 m	22 m
** Hose reel capacity	inner hose Ø	3/8"	1/2"	
	max. length	25 m	25 m	



s. 540 100 bar	8545.200	without hose *	G 1" (f)	G 1" (f)	28,0 kg
	8545.205	without hose **	G 1/2" (f)	G 1/2" (f)	28,5 kg

* Hose reel capacity	inner hose Ø	5/8"	3/4"	1"
	max. length	20 m	22 m	15 m
** Hose reel capacity	inner hose Ø	3/8"	1/2"	5/8"
	max. length	32 m	33 m	36 m



s. 560 100 bar	8565.200	without hose *	G 1" (f)	G 1" (f)	48,5 kg
	8565.206	without hose **	G 1/2" (f)	G 1/2" (m)	47,5 kg

* Hose reel capacity	inner hose Ø	5/8"	3/4"	1"
	max. length	50 m	40 m	30 m
** Hose reel capacity	inner hose Ø	3/8"	1/2"	5/8"
	max. length	60 m	60 m	60 m



Type of fluid
**OIL AND
SIMILAR**

Pressure
**50-100
150 bar**

Material
**- PAINTED STEEL
- ABS**

WITH SPRING



FIXED*

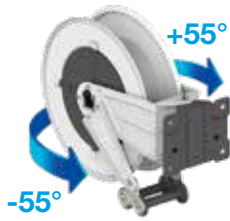

SWIVELLING

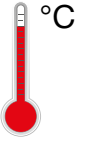

- with hose, see page 139
- without hose, max. 80 °C



In accordance with directive



for ABS versions

* can be rendered swivelling by using the special bracket, see page 81.

DRUM COLOURS

Painted
ABS

Hoses	Connections	Seals	Swivel joint	Central pin
black rubber	galvanized steel	polyurethane	galvanized steel	galvanized steel

Overall dimensions FIXED (mm)			Series	A	B	C	D	E	F	G	H	I	Packaging (mm) W x D x H	
			330	186	140	196	226	98	390	350	365	155		510 x 260 x 520
			390	186	140	196	226	98	410	390	410	155		580 x 280 x 590
			430	186	140	197	226	97	450	415	456	264		580 x 280 x 590
			430 ABS	186	140	197	226	110	450	425	461	259		580 x 280 x 590
			530	203	153	221	258	104	535	510	558	315		650 x 290 x 700
			540	300	218	227	268	165	535	510	572	315		660 x 390 x 690
			560	488	399	238	272	348	535	510	578	315		670 x 610 x 760

Overall dimensions SWIVELLING (mm)			Series	A	B	C	D	E	F	G	H	I	Packaging (mm) W x D x H	
			390	184	146	106	144	98	410	390	482	155		580 x 280 x 590
			430	208	162	118	164	97	450	415	540	264		580 x 280 x 590
			530	228	182	154	200	104	535	510	642	315		650 x 290 x 700
			540	300	218	227	268	165	535	510	700	315		660 x 390 x 690

(W: width - D: depth - H: height)



	P/N		Hose supplied	Connection		Weight		
	fixed	swivelling		inlet	outlet	fixed	swivelling	
s. 330 150 bar	8330.400	-	without hose *	G 1/2" (f)	G 3/8"(f) G 1/2"(f)	11,2 kg	-	
	8330.402	-	12 m - 3/8" (995.312)	G 1/2" (f)	G 1/2" (m)	15,0 kg	-	
* Hose reel capacity			inner hose Ø max. length	1/4" 12 m	5/16" 12 m	3/8" 12 m	1/2" 8 m	
s. 390 150 bar	8390.400	8380.400	without hose *	G 1/2" (f)	G 3/8"(f) G 1/2"(f)	13,0 kg	13,5 kg	
	8390.401	8380.401	12 m - 3/8" (995.312)	G 1/2" (f)	G 1/2" (m)	16,8 kg	17,3 kg	
	8390.402	8380.402	17 m - 3/8" (995.317)	G 1/2" (f)	G 1/2" (m)	18,3 kg	18,8 kg	
* Hose reel capacity			inner hose Ø max. length	1/4" 15 m	5/16" 16 m	3/8" 17 m	1/2" 12 m	
s. 430 150 bar	8430.400	8420.400	without hose *	G 1/2" (f)	G 1/2" (f)	16,0 kg	16,5 kg	
	8430.401	8420.401	10 m - 1/2" (996.310)	G 1/2" (f)	G 1/2" (m)	20,5 kg	21,0 kg	
	8430.402	8420.402	15 m - 1/2" (996.315)	G 1/2" (f)	G 1/2" (m)	12,5 kg	13,0 kg	
	8430.450	-	without hose **	G 1" (f)	G 3/4" (f)	16,8 kg	-	
s. 430 for suction	8430.400/AS	-	without hose *	G 1/2" (f)	G 1/2" (f)	16,0 kg	-	
	8430.401/AS	8420.401/AS	10 m - 1/2" (996.310)	G 1/2" (f)	G 1/2" (m)	20,5 kg	21,0 kg	
	8430.415/AS	-	without hose **	G 1/2" (f)	G 1/2" (m)	16,0 kg	-	
	8430.452/AS	-	8 m - 3/4" (997.3308)	G 1" (f)	G 3/4" (m)	22,0 kg	-	
s. 430 100 bar	8430.415	-	without hose **	G 1/2" (f)	G 1/2" (m)	16,0 kg	-	
	8430.416	-	10 m - 5/8" (999.3310)	G 3/4" (f)	G 3/4" (m)	21,5 kg	-	
	8430.417	-	8 m - 3/4" (997.3308)	G 3/4" (f)	G 3/4" (m)	22,0 kg	-	
s. 430 ABS 150 bar	9430.400	-	without hose *	G 1/2" (f)	G 1/2" (f)	12,5 kg	-	
	9430.401	-	10 m - 1/2" (996.310)	G 1/2" (f)	G 1/2" (m)	17,0 kg	-	
	9430.402	-	15 m - 1/2" (996.315)	G 1/2" (f)	G 1/2" (m)	19,0 kg	-	
s. 430 ABS for suction	9430.400/AS	-	without hose *	G 1/2" (f)	G 1/2" (f)	12,5 kg	-	
s. 430 ABS 100 bar	9430.415	-	without hose **	G 1/2" (f)	G 1/2" (m)	12,5 kg	-	
	9430.416	-	10 m - 5/8" (999.3310)	G 3/4" (f)	G 3/4" (m)	17,0 kg	-	
	9430.417	-	8 m - 3/4" (997.3308)	G 3/4" (f)	G 3/4" (m)	17,5 kg	-	
Hose reel capacity			inner hose Ø max. length	* 5/16" 20 m	3/8" 20 m	1/2" 16 m	** 5/8" 14 m	3/4" 8 m
s. 530 150 bar	8530.400	8520.400	without hose *	G 1/2" (f)	G 1/2" (f)	21,0 kg	22,0 kg	
	8530.401	8520.401	20 m - 1/2" (996.320)	G 1/2" (f)	G 1/2" (m)	29,2 kg	30,2 kg	
	8530.402	8520.402	25 m - 1/2" (996.325)	G 1/2" (f)	G 1/2" (m)	31,1 kg	32,1 kg	
s. 530 100 bar	8530.415	-	without hose **	G 1" (f)	G 1" (f)	21,0 kg	-	
	8530.416	-	12 m - 3/4" (997.3312)	G 1" (f)	G 3/4" (m)	28,8 kg	-	
Hose reel capacity			inner hose Ø max. length	* 3/8" 25 m	1/2" 25 m	5/8" 22 m	** 3/4" 12 m	1" 8 m
s. 540 150 bar	8540.400	8550.400	without hose *	G 1" (f)	G 1" (f)	28,0 kg	33,5 kg	
	8540.405	8550.405	without hose **	G 1/2" (f)	G 1/2" (f)	28,0 kg	33,5 kg	
	8540.406	8550.406	30 m - 1/2" (996.330)	G 1/2" (f)	G 1/2" (m)	40,3 kg	45,8 kg	
s. 540 100 bar	8540.411	8550.411	15 m - 3/4" (997.3315)	G 1" (f)	G 3/4" (m)	37,6 kg	43,1 kg	
	8540.412	8550.412	20 m - 3/4" (997.3320)	G 1" (f)	G 3/4" (m)	40,2 kg	45,7 kg	
s. 540 50 bar	8540.413	8550.413	15 m - 1" (998.3315)	G 1" (f)	G 1" (m)	42,6 kg	48,1 kg	
	8540.414	-	10 m - 1" (998.3310)	G 1" (f)	G 1" (m)	38,2 kg	-	
Hose reel capacity			inner hose Ø max. length	* 3/4" 22 m	1" 15 m	** 3/8" 30 m	1/2" 30 m	5/8" 30 m
s. 560 150 bar	8560.400	-	without hose *	G 1" (f)	G 1" (f)	48,0 kg	-	
* Hose reel capacity			inner hose Ø max. length	5/8" 50 m	3/4" 40 m	1" 30 m		

Prepared with outlet connection for Ø 3/4" hoses



Type of fluid
**OIL AND
SIMILAR**

Pressure
150 bar

Material
**- AISI 304 S. STEEL
- ABS**

WITH SPRING



FIXED*

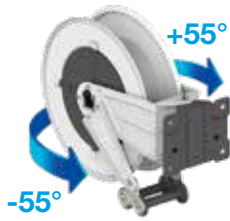

SWIVELLING

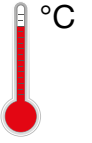

- with hose, see page 139
- without hose, max. 130 °C



In accordance with directive



for ABS versions

* can be rendered swivelling by using the special bracket, see page 81.

DRUM COLOURS

ABS

Seals	Swivel joint	Central pin
Viton®	AISI 304 s. steel	AISI 304 s. steel
		

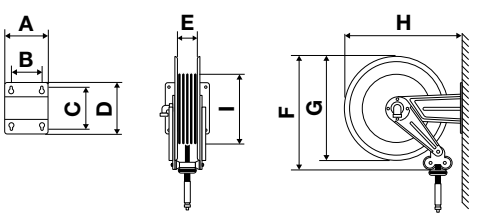
Overall dimensions FIXED (mm)	Series	A	B	C	D	E	F	G	H	I	Packaging (mm) W x D x H
		390	186	140	196	226	98	410	390	410	
	430	186	140	197	226	97	450	415	456	264	580 x 280 x 590
	430 ABS	186	140	197	226	110	450	425	461	259	580 x 280 x 590
	530	203	153	221	258	104	535	510	558	315	650 x 290 x 700
	540	300	218	227	268	165	535	510	572	315	660 x 390 x 690

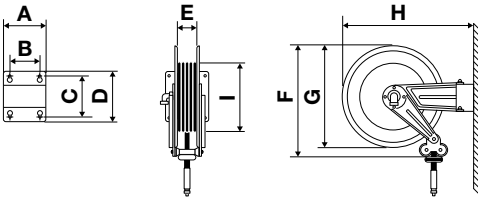
Overall dimensions SWIVELLING (mm)	Series	A	B	C	D	E	F	G	H	I	Packaging (mm) W x D x H
		390	184	146	106	144	98	410	390	482	
	430	208	162	118	164	97	450	415	540	264	580 x 280 x 590
	530	228	182	154	200	104	535	510	642	315	650 x 290 x 700
	540	300	218	227	268	165	535	510	700	315	660 x 390 x 690

(W: width - D: depth - H: height)



	P/N		Hose supplied	Connection		Weight	
	fixed	swivelling		inlet	outlet	fixed	swivelling
s. 390	8392.200	8382.200	without hose *	G 1/2" (f)	G 3/8"(f) G 1/2"(f)	13,0 kg	13,5 kg

* Hose reel capacity	inner hose Ø	1/4"	5/16"	3/8"	1/2"		
	max. length	15 m	16 m	17 m	12 m		



s. 430	8434.200	8424.200	without hose *	G 1/2" (f)	G 1/2" (f)	16,0 kg	16,5 kg
	8434.250	-	without hose **	G 1" (f)	G 3/4" (f)	17,0 kg	-

Hose reel capacity	inner hose Ø	* 5/16"	3/8"	1/2"	** 5/8"	3/4"	
	max. length	20 m	20 m	16 m	14 m	8 m	



s. 430 ABS	9434.200	-	without hose *	G 1/2" (f)	G 1/2" (f)	12,5 kg	-
	9432.401	-	10 m - 1/2" (996.310)	G 1/2" (f)	G 1/2" (m)	16,9 kg	-
	9432.402	-	15 m - 1/2" (996.315)	G 1/2" (f)	G 1/2" (m)	20,0 kg	-

* Hose reel capacity	inner hose Ø	5/16"	3/8"	1/2"			
	max. length	20 m	20 m	16 m			



s. 530	8534.200	8524.200	without hose *	G 1/2" (f)	G 1/2" (f)	21,0 kg	22,0 kg
	8534.250	-	without hose **	G 1" (f)	G 1" (f)	22,5 kg	-

Hose reel capacity	inner hose Ø	* 3/8"	1/2"	5/8"	** 3/4"	1"	
	max. length	25 m	25 m	22 m	12 m	8 m	



s. 540	8544.200	8554.200	without hose *	G 1" (f)	G 1" (f)	28,0 kg	33,5 kg
	8544.205	8554.205	without hose **	G 1/2" (f)	G 1/2" (f)	28,5 kg	34,0 kg

Hose reel capacity	inner hose Ø	* 3/4"	1"	** 3/8"	1/2"	5/8"	
	max. length	22 m	15 m	30 m	30 m	30 m	



Type of fluid
GREASE

Pressure
400-600 bar

Material
- PAINTED STEEL
- ABS

WITH SPRING



FIXED*



SWIVELLING

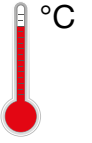

- with hose, see page 139
- without hose, max. 80 °C



In accordance with directive



for ABS versions

* can be rendered swivelling by using the special bracket, see page 81.

DRUM COLOURS

Painted
ABS

Hoses	Connections	Seals	Swivel joint	Central pin
black rubber	galvanized steel	polyurethane	galvanized steel	galvanized steel

Overall dimensions FIXED (mm)			Series	A	B	C	D	E	F	G	H	I	Packaging (mm) W x D x H	
			330	186	140	196	226	98	390	350	365	155		510 x 260 x 520
			390	186	140	196	226	98	410	390	410	155		580 x 280 x 590
			430	186	140	197	226	97	450	415	456	264		580 x 280 x 590
			430 ABS	186	140	197	226	110	450	425	461	259		580 x 280 x 590
			530	203	153	221	258	104	535	510	558	315		650 x 290 x 700
			540	300	218	227	268	165	535	510	572	315		660 x 390 x 690

Overall dimensions SWIVELLING (mm)			Series	A	B	C	D	E	F	G	H	I	Packaging (mm) W x D x H	
			390	184	146	106	144	98	410	390	482	155		580 x 280 x 590
			430	208	162	118	164	97	450	415	540	264		580 x 280 x 590
			530	228	182	154	200	104	535	510	642	315		650 x 290 x 700
			540	300	218	227	268	165	535	510	700	315		660 x 390 x 690

(W: width - D: depth - H: height)



	P/N		Hose supplied	Connection		Weight	
	fixed	swivelling		inlet	outlet	fixed	swivelling
s. 330 600 bar	8330.500	-	without hose *	G 3/8" (f)	G 3/8" (f)	11,2 kg	-
s. 330 400 bar	8330.501	-	12 m - 1/4" (993.511)	G 3/8" (f)	G 1/4" (m)	15,2 kg	-

* Hose reel capacity	inner hose Ø	1/4"	5/16"	3/8"	1/2"		
	max. length	12 m	12 m	12 m	8 m		



s. 390 600 bar	8390.500	8380.500	without hose *	G 3/8" (f)	G 3/8" (f)	13,0 kg	13,5 kg
s. 390 400 bar	8390.501	8380.501	12 m - 1/4" (993.511)	G 3/8" (f)	G 1/4" (m)	17,0 kg	17,5 kg
	8390.502	8380.502	16 m - 1/4" (993.516)	G 3/8" (f)	G 1/4" (m)	18,0 kg	18,5 kg

* Hose reel capacity	inner hose Ø	1/4"	5/16"	3/8"	1/2"		
	max. length	16 m	16 m	17 m	12 m		



s. 430 600 bar	8430.500	8420.500	without hose *	G 3/8" (f)	G 1/2" (f)	16,0 kg	16,5 kg
s. 430 400 bar	8430.501	8420.501	12 m - 1/4" (993.512)	G 3/8" (f)	G 1/4" (m)	20,0 kg	20,5 kg
	8430.502	8420.502	18 m - 1/4" (993.518)	G 3/8" (f)	G 1/4" (m)	21,7 kg	22,2 kg
	8430.505	8420.505	10 m - 3/8" (995.710)	G 3/8" (f)	G 1/4" (m)	20,8 kg	21,3 kg
	8430.506	8420.506	15 m - 3/8" (995.715)	G 3/8" (f)	G 1/4" (m)	22,7 kg	23,2 kg

* Hose reel capacity	inner hose Ø	5/16"	3/8"				
	max. length	12 m	15 m				



s. 430 ABS 600 bar	9430.500	-	without hose *	G 3/8" (f)	G 1/2" (f)	12,5 kg	-
s. 430 ABS 400 bar	9430.501	-	12 m - 1/4" (993.512)	G 3/8" (f)	G 1/4" (m)	16,5 kg	-
	9430.502	-	18 m - 1/4" (993.518)	G 3/8" (f)	G 1/4" (m)	18,2 kg	-
	9430.505	-	10 m - 3/8" (995.710)	G 3/8" (f)	G 1/4" (m)	17,3 kg	-
	9430.506	-	15 m - 3/8" (995.715)	G 3/8" (f)	G 1/4" (m)	19,2 kg	-

* Hose reel capacity	inner hose Ø	5/16"	3/8"				
	max. length	12 m	15 m				



s. 530 600 bar	8530.500	8520.500	without hose *	G 3/8" (f)	G 1/2" (f)	21,0 kg	22,0 kg
s. 530 400 bar	8530.501	8520.501	20 m - 3/8" (995.720)	G 3/8" (f)	G 1/4" (m)	29,6 kg	30,6 kg
	8530.502	8520.502	25 m - 3/8" (995.725)	G 3/8" (f)	G 1/4" (m)	31,6 kg	32,6 kg

* Hose reel capacity	inner hose Ø	3/8"	1/2"				
	max. length	25 m	25 m				



s. 540 600 bar	8540.500	8550.500	without hose *	G 3/8" (f)	G 1/2" (f)	28,0 kg	33,5 kg
s. 540 400 bar	8540.501	8550.501	30 m - 3/8" (995.730)	G 3/8" (f)	G 1/4" (m)	41,0 kg	46,5 kg

* Hose reel capacity	inner hose Ø	3/8"	1/2"	5/8"			
	max. length	30 m	30 m	30 m			



Type of fluid
GREASE

Pressure
400-600 bar

Material
- AISI 304 S. STEEL
- ABS

WITH SPRING



FIXED*

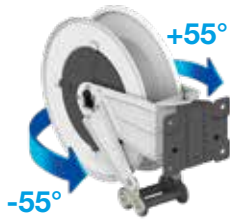

SWIVELLING

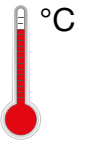

- with hose, see page 139
- without hose, max. 80 °C



In accordance with directive





for ABS versions



* can be rendered swivelling by using the special bracket, see page 81.

DRUM COLOURS

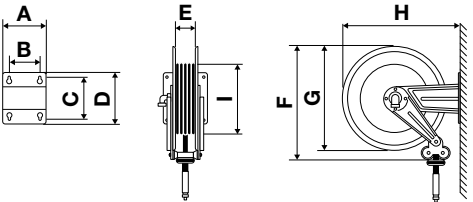
ABS

Hoses	Connections	Seals	Swivel joint	Central pin
black rubber	galvanized steel	polyurethane	galvanized steel	AISI 304 s. steel
				

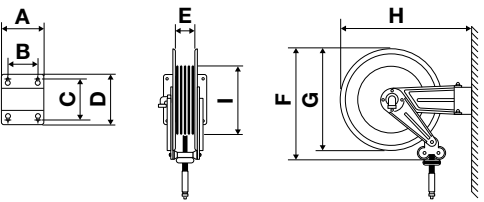
Overall dimensions FIXED (mm)			Series	A	B	C	D	E	F	G	H	I	Packaging (mm) W x D x H
	390	186	140	196	226	98	410	390	410	155		580 x 280 x 590	
	430	186	140	197	226	97	450	415	456	264		580 x 280 x 590	
	430 ABS	186	140	197	226	110	450	425	461	259	580 x 280 x 590		
	530	203	153	221	258	104	535	510	558	315	650 x 290 x 700		

Overall dimensions SWIVELLING (mm)			Series	A	B	C	D	E	F	G	H	I	Packaging (mm) W x D x H
	390	184	146	106	144	98	410	390	482	155		580 x 280 x 590	
	430	208	162	118	164	97	450	415	540	264		580 x 280 x 590	
	530	228	182	154	200	104	535	510	642	315		650 x 290 x 700	

(W: width - D: depth - H: height)



P/N		Hose supplied	Connection		Weight	
fixed	swivelling		inlet	outlet	fixed	swivelling

s. 390 600 bar	8392.500	8382.500	without hose *	G 3/8" (f)	G 3/8" (f)	13,0 kg	13,5 kg
--------------------------	-----------------	-----------------	----------------	------------	------------	---------	---------

* Hose reel capacity	inner hose Ø	1/4"	5/16"	3/8"	1/2"
	max. length	15 m	16 m	17 m	12 m

s. 430 600 bar	8432.500	8422.500	without hose *	G 3/8" (f)	G 1/2" (f)	16,0 kg	16,5 kg
--------------------------	-----------------	-----------------	----------------	------------	------------	---------	---------

* Hose reel capacity	inner hose Ø	5/16"	3/8"
	max. length	12 m	15 m

s. 430 ABS 600 bar	9432.500	-	without hose *	G 3/8" (f)	G 1/2" (f)	12,5 kg	-
------------------------------	-----------------	---	----------------	------------	------------	---------	---

s. 430 ABS 400 bar	9432.501	-	12 m - 1/4" (993.512)	G 3/8" (f)	G 1/4" (m)	16,5 kg	-
	9432.502	-	18 m - 1/4" (993.518)	G 3/8" (f)	G 1/4" (m)	18,2 kg	-
	9432.505	-	10 m - 3/8" (995.710)	G 3/8" (f)	G 1/4" (m)	17,3 kg	-
	9432.506	-	15 m - 3/8" (995.715)	G 3/8" (f)	G 1/4" (m)	19,2 kg	-

* Hose reel capacity	inner hose Ø	5/16"	3/8"
	max. length	12 m	15 m

s. 530 600 bar	8532.500	8522.500	without hose *	G 3/8" (f)	G 1/2" (m)	21,0 kg	22,0 kg
--------------------------	-----------------	-----------------	----------------	------------	------------	---------	---------

* Hose reel capacity	inner hose Ø	3/8"	1/2"
	max. length	25 m	25 m



Type of fluid
DIESEL

Pressure
10-20 bar

Material
- PAINTED STEEL
- ABS

WITH SPRING



FIXED*

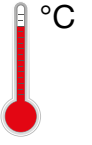

- with hose, see page 139
- without hose, max. 100 °C

In accordance with directive



for ABS versions

* can be rendered swivelling by using the special bracket, see page 81.

DRUM COLOURS

Painted
ABS

Hoses	Connections	Seals	Swivel joint	Central pin
black antistatic rubber	galvanized steel	Viton®	brass	galvanized steel

Overall dimensions (mm)		Series	A	B	C	D	E	F	G	H	I	Packaging (mm) W x D x H
		430	186	140	197	226	97	450	415	456	264	580 x 280 x 590
		430 ABS	186	140	197	226	110	450	425	461	259	580 x 280 x 590
		530	203	153	221	258	104	535	510	558	315	650 x 290 x 700
		540	300	218	227	268	165	535	510	572	315	660 x 390 x 690
		560	488	399	238	272	348	535	510	578	315	670 x 610 x 760



P/N	Hose supplied	Connection		Weight	
		inlet	outlet		
s. 430 20 bar	8430.150	without hose *	G 1" (f)	G 3/4" (f)	17,0 kg
	8430.600	without hose *	G 1/2" (f)	G 1/2" (m)	16,0 kg
s. 430 10 bar	8430.601	10 m - 5/8" (999.810)	G 3/4" (f)	G 3/4" (m)	20,4 kg
	8430.602	8 m - 3/4" (997.808)	G 3/4" (f)	G 3/4" (m)	22,5 kg
* Hose reel capacity		inner hose Ø max. length	1/2" 5/8" 3/4" 16 m 14 m 8 m		
s. 430 20 bar	9430.600	without hose *	G 1/2" (f)	G 1/2" (m)	12,5 kg
s. 430 10 bar	9430.601	10 m - 5/8" (999.810)	G 3/4" (f)	G 3/4" (m)	16,9 kg
	9430.602	8 m - 3/4" (997.808)	G 3/4" (f)	G 3/4" (m)	19,0 kg
* Hose reel capacity		inner hose Ø max. length	1/2" 5/8" 3/4" 16 m 14 m 8 m		
s. 530 20 bar	8530.150	without hose *	G 1" (f)	G 1" (f)	21,0 kg
s. 530 10 bar	8530.603	12 m - 3/4" (997.812)	G 1" (f)	G 3/4" (m)	26,6 kg
	8530.604	8 m - 1" (998.808)	G 1" (f)	G 1" (m)	28,0 kg
* Hose reel capacity		inner hose Ø max. length	5/8" 3/4" 1" 22 m 12 m 8 m		
s. 540 20 bar	8540.100	without hose *	G 1" (f)	G 1" (f)	28,0 kg
s. 540 10 bar	8540.601	15 m - 3/4" (997.815)	G 1" (f)	G 3/4" (m)	35,2 kg
	8540.602	20 m - 3/4" (997.820)	G 1" (f)	G 3/4" (m)	37,9 kg
	8540.603	15 m - 1" (998.815)	G 1" (f)	G 1" (m)	39,3 kg
* Hose reel capacity		inner hose Ø max. length	3/4" 1" 22 m 15 m		
s. 560 20 bar	8560.100	without hose *	G 1" (f)	G 1" (f)	48,0 kg
s. 560 10 bar	8560.603	40 m - 3/4" (997.840)	G 1" (f)	G 3/4" (m)	66,4 kg
	8560.604	20 m - 1" (998.820)	G 1" (f)	G 1" (m)	62,6 kg
	8560.605	30 m - 1" (998.830)	G 1" (f)	G 1" (m)	70,4 kg
* Hose reel capacity		inner hose Ø max. length	3/4" 1" 40 m 30 m		

Prepared with outlet connection for Ø 3/4" hoses



Type of fluid
DIESEL

Pressure
10-20 bar

Material
AISI 304 S. STEEL

WITH SPRING



FIXED*

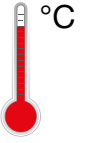

- with hose, see page 139
- without hose, max. 100 °C





In accordance with directive

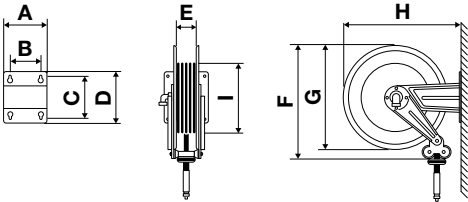

* can be rendered swivelling by using the special bracket, see page 81.

Hoses	Connections	Seals	Swivel joint	Central pin
black antistatic rubber	galvanized steel	Viton®	brass	AISI 304 s. steel
				

Overall dimensions (mm)		Series	A	B	C	D	E	F	G	H	I	Packaging (mm) W x D x H	
		530	203	153	221	258	104	535	510	558	315		650 x 290 x 700
		540	300	218	227	268	165	535	510	572	315		660 x 390 x 690
		560	488	399	238	272	348	535	510	578	315		670 x 610 x 760

(W: width - D: depth - H: height)



P/N	Hose supplied	Connection		Weight
		inlet	outlet	

s. 530 20 bar	8532.150	without hose *	G 1" (f)	G 1" (f)	21,0 kg
-------------------------	-----------------	----------------	----------	----------	---------

* Hose reel capacity	inner hose ø	5/8"	3/4"	1"
	max. length	22 m	12 m	8 m

s. 540 20 bar	8542.100	without hose *	G 1" (f)	G 1" (f)	28,0 kg
-------------------------	-----------------	----------------	----------	----------	---------

s. 540 10 bar	8542.601	15 m - 3/4" (997.815)	G 1" (f)	G 3/4" (m)	35,2 kg
-------------------------	-----------------	-----------------------	----------	------------	---------

	8542.602	20 m - 3/4" (997.820)	G 1" (f)	G 3/4" (m)	37,9 kg
--	-----------------	-----------------------	----------	------------	---------

	8542.603	15 m - 1" (998.815)	G 1" (f)	G 1" (m)	39,3 kg
--	-----------------	---------------------	----------	----------	---------

* Hose reel capacity	inner hose ø	3/4"	1"
	max. length	22 m	15 m

s. 560 20 bar	8562.100	without hose *	G 1" (f)	G 1" (f)	48,0 kg
-------------------------	-----------------	----------------	----------	----------	---------

s. 560 10 bar	8562.603	40 m - 3/4" (997.840)	G 1" (f)	G 3/4" (m)	66,4 kg
-------------------------	-----------------	-----------------------	----------	------------	---------

	8562.604	20 m - 1" (998.820)	G 1" (f)	G 1" (m)	62,6 kg
--	-----------------	---------------------	----------	----------	---------

	8562.605	30 m - 1" (998.830)	G 1" (f)	G 1" (m)	70,4 kg
--	-----------------	---------------------	----------	----------	---------

* Hose reel capacity	inner hose ø	3/4"	1"
	max. length	40 m	30 m



Type of fluid
AdBlue®

Pressure
10-100 bar

Material
- **PAINTED STEEL**
- **AISI 304 S. STEEL**
- **ABS**

WITH SPRING



FIXED*

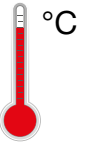

- with hose, see page 139
- without hose, max. 130 °C



In accordance with directive



for ABS versions

* can be rendered swivelling by using the special bracket, see page 81.

DRUM COLOURS



Hoses	Connections	Seals	Swivel joint	Central pin
Antistatic EPDM	AISI 304 stainless steel	Viton®	AISI 304 stainless steel	AISI 304 stainless steel
			AISI 316 stainless steel	AISI 316 stainless steel

Overall dimensions (mm)		Series	A	B	C	D	E	F	G	H	I	Packaging (mm) W x D x H
		436 painted	337	302	160	203	150	450	415	456	264	580 x 280 x 590
		436 ABS	186	140	197	226	110	450	425	461	259	580 x 280 x 590
		437 s. steel	186	140	197	226	97	450	415	456	264	580 x 280 x 590
		437 ABS	186	140	197	226	110	450	425	461	259	580 x 280 x 590
		537	203	153	221	258	104	535	510	558	315	650 x 290 x 700

(W: width - D: depth - H: height)

See specific catalogue



P/N	Central pin swivel joint	Hose supplied	Connection		Weight
			inlet	outlet	

PAINTED STEEL

 s. 436 painted 100 bar	8436.200	AISI 316 stainless steel	without hose *	G 1" (f)	G 3/4" (f)	20,0 kg
	8436.250	AISI 304 stainless steel	without hose *	G 1" (f)	G 3/4" (f)	22,0 kg
s. 436 painted 10 bar	8436.251	AISI 304 stainless steel	10 m - 19 x 27 mm (987.210)	G 3/4" (f)	G 3/4" (m)	29,4 kg
	8436.252	AISI 304 stainless steel	15 m - 19 x 27 mm (987.215)	G 3/4" (f)	G 3/4" (m)	32,4 kg

* Hose reel capacity	inner hose Ø	1/2"	5/8"	3/4"
	max. length	16 m	14 m	8 m

 s. 436 ABS 100 bar	9436.200	AISI 304 stainless steel	without hose *	G 1/2" (f)	G 1/2" (m)	15,8 kg
	9436.201	AISI 304 stainless steel	8 m - 19 x 27 mm (987.208)	G 3/4" (f)	G 3/4" (m)	20,7 kg

* Hose reel capacity	inner hose Ø	1/2"	5/8"	3/4"
	max. length	16 m	14 m	8 m

AISI 304 STAINLESS STEEL

 s. 437 s. steel 100 bar	8434.250	AISI 304 stainless steel	without hose *	G 1" (f)	G 3/4" (f)	17,0 kg
--	-----------------	--------------------------	----------------	----------	------------	---------

* Hose reel capacity	inner hose Ø	1/2"	5/8"	3/4"
	max. length	16 m	14 m	8 m

 s. 437 ABS 100 bar	9437.200	AISI 304 stainless steel	without hose *	G 1/2" (f)	G 1/2" (m)	15,8 kg
	9437.201	AISI 304 stainless steel	8 m - 19 x 27 mm (987.208)	G 3/4" (f)	G 3/4" (m)	20,7 kg

* Hose reel capacity	inner hose Ø	1/2"	5/8"	3/4"
	max. length	16 m	14 m	8 m

 s. 537 s. steel 100 bar	8537.200	AISI 316 stainless steel	without hose *	G 1" (f)	G 1" (f)	22,5 kg
	8534.250	AISI 304 stainless steel	without hose *	G 1" (f)	G 1" (f)	22,5 kg
s. 537 s. steel 10 bar	8537.251	AISI 304 stainless steel	10 m - 19 x 27 mm (987.210)	G 3/4" (f)	G 3/4" (m)	27,0 kg
	8537.252	AISI 304 stainless steel	15 m - 19 x 27 mm (987.215)	G 3/4" (f)	G 3/4" (m)	31,0 kg

* Hose reel capacity	inner hose Ø	5/8"	3/4"	1"
	max. length	22 m	12 m	8 m

 Prepared with outlet connection for Ø 3/4" hoses



Type of fluid
LPG-METHANE

Pressure
20 bar

Material
PAINTED STEEL

WITH SPRING



FIXED*

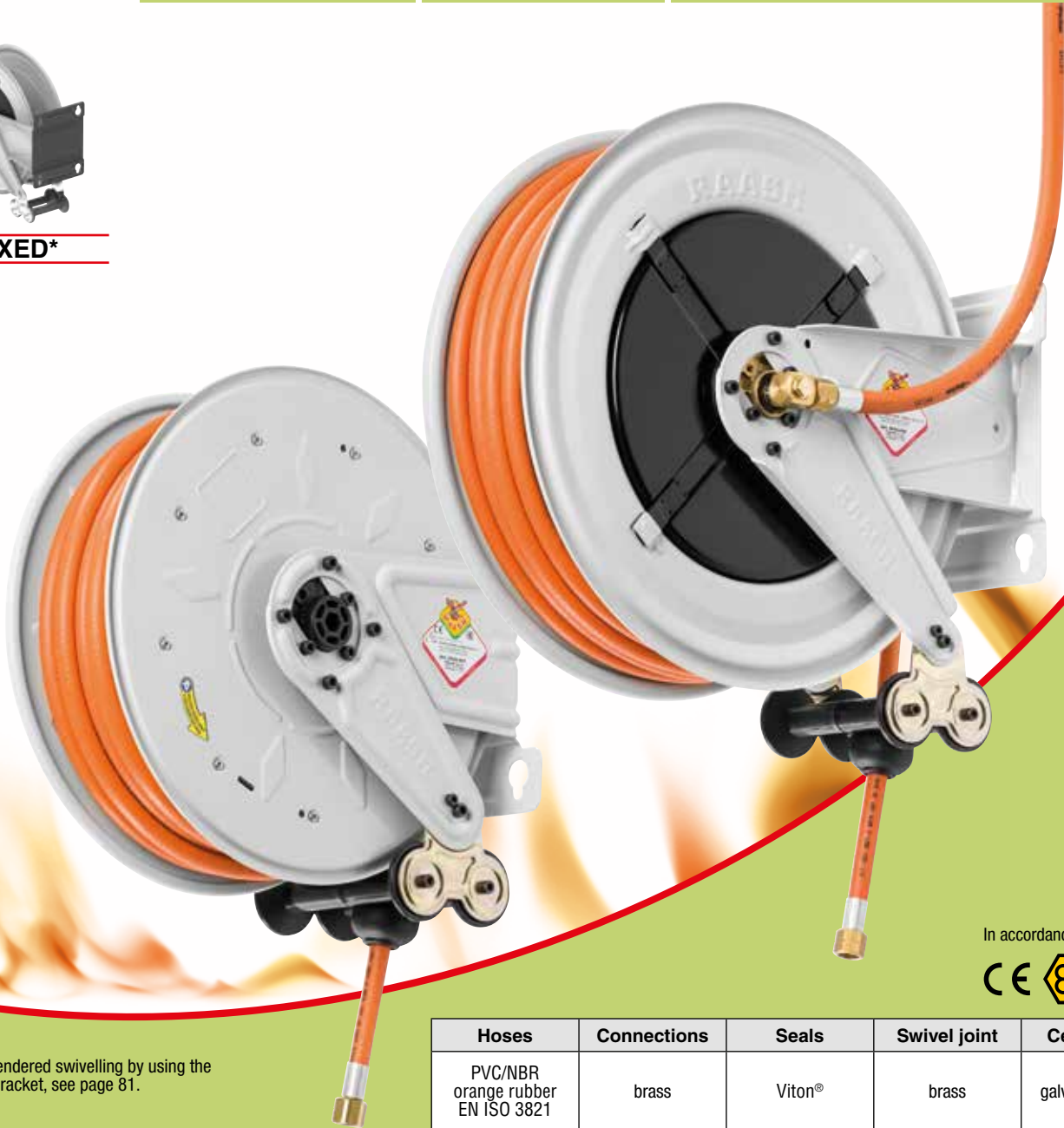

In accordance with directive





* can be rendered swivelling by using the special bracket, see page 81.

DRUM COLOURS

S. 330 - 390

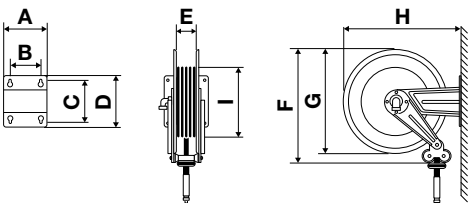
Hoses	Connections	Seals	Swivel joint	Central pin
PVC/NBR orange rubber EN ISO 3821	brass	Viton®	brass	galvanized steel
				

Overall dimensions (mm)											Series	A	B	C	D	E	F	G	H	I	Packaging (mm) W x D x H
																					
											330	186	140	196	226	98	390	350	365	155	510 x 260 x 520
											390	186	140	196	226	98	410	390	410	155	580 x 280 x 590
											430	186	140	197	226	97	450	415	456	264	580 x 280 x 590
											530	203	153	221	258	104	535	510	558	315	650 x 290 x 700
											540	300	218	227	268	165	535	510	572	315	660 x 390 x 690

(W: width - D: depth - H: height)



	P/N	Hose supplied	Connection		Weight	
			inlet	outlet		
s. 330	8330.800	without hose *	G 3/8" (m) LH	G 3/8" (m) LH	12,5 kg	
	8330.801	8 m - 8 x 15 mm (974.1008)	G 3/8" (f) LH	G 3/8" (f) LH	14,5 kg	
	8330.802	10 m - 10 x 17 mm (975.1010)	G 3/8" (f) LH	G 3/8" (f) LH	15,3 kg	
* Hose reel capacity		inner hose Ø	1/4"	5/16"	3/8"	1/2"
		max. length	20 m	20 m	18 m	15 m
s. 390	8390.800	without hose *	G 3/8" (m) LH	G 3/8" (m) LH	13,5 kg	
	8390.801	15 m - 8 x 15 mm (974.1015)	G 3/8" (f) LH	G 3/8" (f) LH	16,6 kg	
	8390.802	15 m - 10 x 17 mm (975.1015)	G 3/8" (f) LH	G 3/8" (f) LH	17,3 kg	
* Hose reel capacity		inner hose Ø	1/4"	5/16"	3/8"	1/2"
		max. length	20 m	20 m	18 m	15 m
s. 430	8430.800	without hose *	G 3/8" (m) LH	G 3/8" (m) LH	18,5 kg	
	8430.802	20 m - 8 x 15 mm (974.1020)	G 3/8" (f) LH	G 3/8" (f) LH	22,3 kg	
	8430.804	18 m - 10 x 17 mm (975.1018)	G 3/8" (f) LH	G 3/8" (f) LH	23,0 kg	
* Hose reel capacity		inner hose Ø	5/16"	3/8"	1/2"	5/8"
		max. length	20 m	20 m	16 m	14 m
s. 530	8530.800	without hose *	G 3/8" (m) LH	G 3/8" (m) LH	21,0 kg	
	8530.802	28 m - 8 x 15 mm (974.1028)	G 3/8" (f) LH	G 3/8" (f) LH	26,3 kg	
	8530.804	27 m - 10 x 17 mm (975.1027)	G 3/8" (f) LH	G 3/8" (f) LH	28,0 kg	
* Hose reel capacity		inner hose Ø	3/8"	1/2"	5/8"	
		max. length	25 m	25 m	22 m	
s. 540	8540.800	without hose *	G 3/8" (m) LH	G 3/8" (m) LH	28,0 kg	
	8540.802	30 m - 10 x 17 mm (975.1030)	G 3/8" (f) LH	G 3/8" (f) LH	35,0 kg	
* Hose reel capacity		inner hose Ø	3/8"	1/2"	5/8"	
		max. length	30 m	30 m	30 m	

LH (Left hand): counter-clockwise turning direction



Hose reel
WELDING

Pressure
20 bar

Material
PAINTED STEEL

WITH SPRING



FIXED*





In accordance with directive

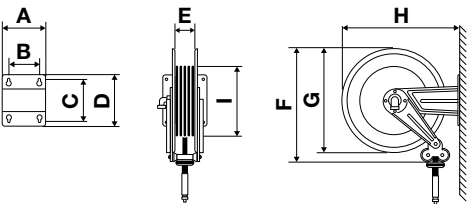

* can be rendered swivelling by using the special bracket, see page 81.

Hoses	Connections	Seals	Swivel joint	Central pin
SBR/EPDM for oxy-acetylene EN ISO 3821	brass	Viton®	brass	galvanized steel
				

Overall dimensions (mm)		Series	A	B	C	D	E	F	G	H	I	Packaging (mm) W x D x H
		430	186	140	197	226	97	450	415	456	264	 580 x 280 x 590
		530	203	153	221	258	104	535	510	558	315	650 x 290 x 700
		540	300	218	227	268	165	535	510	572	315	660 x 390 x 690

(W: width - D: depth - H: height)



	P/N	Hose supplied	Connection		Weight
			inlet	outlet	
s. 430	8430.700	without hose *	G 3/8" (m)	G 3/8" (m)	18,5 kg
	8430.701	13 m - 2 x 6 mm - (2 x 1/4") (973.913)	G 3/8" (f)	G 3/8" (f)	23,7 kg
	8430.702	12 m - 2 x 8 mm - (2 x 5/16") (974.912)	G 3/8" (f)	G 3/8" (f)	23,4 kg
* Hose reel capacity		inner hose Ø	2 x 1/4"	2 x 5/16"	2 x 3/8"
		max. length	13 m	12 m	10 m
s. 530	8530.700	without hose *	G 3/8" (m)	G 3/8" (m)	23,2 kg
	8530.701	17 m - 2 x 6 mm - (2 x 1/4") (973.917)	G 3/8" (f)	G 3/8" (f)	29,7 kg
	8530.702	20 m - 2 x 6 mm - (2 x 1/4") (973.920)	G 3/8" (f)	G 3/8" (f)	30,9 kg
	8530.703	15 m - 2 x 8 mm - (2 x 5/16") (974.915)	G 3/8" (f)	G 3/8" (f)	29,4 kg
	8530.704	20 m - 2 x 8 mm - (2 x 5/16") (974.920)	G 3/8" (f)	G 3/8" (f)	31,7 kg
	8530.705	15 m - 2 x 9 mm - (2 x 3/8") (975.915)	G 3/8" (f)	G 3/8" (f)	31,5 kg
* Hose reel capacity		inner hose Ø	2 x 1/4"	2 x 5/16"	2 x 3/8"
		max. length	22 m	20 m	15 m
s. 540	8540.700	without hose *	G 3/8" (m)	G 3/8" (m)	30,0 kg
	8540.701	25 m - 2 x 6 mm (2 x 1/4") (973.925)	G 3/8" (f)	G 3/8" (f)	38,8 kg
	8540.702	30 m - 2 x 6 mm (2x1/4") (973.930)	G 3/8" (f)	G 3/8" (f)	39,2 kg
	8540.704	25 m - 2 x 8 mm (2 x 5/16") (974.925)	G 3/8" (f)	G 3/8" (f)	40,2 kg
	8540.705	30 m - 2 x 8 mm (2 x 5/16") (974.930)	G 3/8" (f)	G 3/8" (f)	42,2 kg
	8540.707	20 m - 2 x 9 mm (2 x 3/8") (975.920)	G 3/8" (f)	G 3/8" (f)	40,0 kg
	8540.709	27 m - 2 x 9 mm (2 x 3/8") (975.927)	G 3/8" (f)	G 3/8" (f)	42,6 kg
* Hose reel capacity		inner hose Ø	2 x 1/4"	2 x 5/16"	2 x 3/8"
		max. length	37 m	35 m	27 m



Hose reel
**DOUBLE INLET AND
 DOUBLE OUTLET**

Pressure
**20-150-200
 400-700 bar**

Material
**PAINTED
 STEEL**

WITH SPRING



FIXED*



In accordance with directive



* can be rendered swivelling by using the special bracket, see page 81.

	Seals	Swivel joint	Central pin
AIR-WATER 20 bar	Viton®	brass	galvanized steel
OIL-WATER 200 bar	Viton®	AISI 304 s. steel	galvanized steel
OIL-PAINTS 150 bar	polyurethane	galvanized steel	galvanized steel
OIL 400 bar	polyurethane	galvanized steel	galvanized steel
OIL-WATER 700 bar	Viton® - Teflon®	AISI 304 s. steel	galvanized steel



Overall dimensions (mm)			Series	A	B	C	D	E	F	G	H	I	Packaging (mm) W x D x H	
			430	186	140	197	226	97	450	415	456	264		580 x 280 x 590
			530	203	153	221	258	104	535	510	558	315		650 x 290 x 700
			540	300	218	227	268	165	535	510	572	315		660 x 390 x 690

(W: width - D: depth - H: height)

Twin hose reels can be used for all applications that need to simultaneously supply two fluids or to recirculate a single fluid.



s. 430



s. 530



s. 540

P/N	Hose supplied	Connection		Weight
		inlet	outlet	

AIR-WATER 20 bar

s. 430	8430.1000	without hose *		G 1/2" (f)	G 3/8" (m)	18,0 kg
* Hose reel capacity		inner hose Ø	2 x 1/4"	2 x 5/16"	2 x 3/8"	
		max. length	13 m	12 m	10 m	
s. 530	8530.1000	without hose *		G 1/2" (f)	G 3/8" (m)	25,0 kg
* Hose reel capacity		inner hose Ø	2 x 1/4"	2 x 5/16"	2 x 3/8"	
		max. length	22 m	20 m	15 m	
s. 540	8540.1000	without hose *		G 1/2" (f)	G 3/8" (m)	30,0 kg
* Hose reel capacity		inner hose Ø	2 x 1/4"	2 x 5/16"	2 x 3/8"	
		max. length	37 m	35 m	25 m	

OIL-WATER 200 bar

s. 430	8430.3000	without hose *		G 3/8" (f)	G 3/8" (m)	18,0 kg
* Hose reel capacity		inner hose Ø	2 x 1/4"	2 x 5/16"	2 x 3/8"	
		max. length	13 m	12 m	10 m	
s. 530	8530.3000	without hose *		G 3/8" (f)	G 3/8" (m)	25,0 kg
* Hose reel capacity		inner hose Ø	2 x 1/4"	2 x 5/16"	2 x 3/8"	
		max. length	22 m	20 m	15 m	
s. 540	8540.3000	without hose *		G 3/8" (f)	G 3/8" (m)	30,0 kg
* Hose reel capacity		inner hose Ø	2 x 1/4"	2 x 5/16"	2 x 3/8"	
		max. length	37 m	35 m	27 m	

OIL-PAINTS 150 bar

s. 430	8430.4000	without hose *		G 1/2" (f)	G 3/8" (m)	18,0 kg
* Hose reel capacity		inner hose Ø	2 x 1/4"	2 x 5/16"	2 x 3/8"	
		max. length	13 m	12 m	10 m	
s. 530	8530.4000	without hose *		G 1/2" (f)	G 3/8" (m)	25,0 kg
* Hose reel capacity		inner hose Ø	2 x 1/4"	2 x 5/16"	2 x 3/8"	
		max. length	22 m	20 m	15 m	
s. 540	8540.4000	without hose *		G 1/2" (f)	G 3/8" (m)	30,0 kg
* Hose reel capacity		inner hose Ø	2 x 1/4"	2 x 5/16"	2 x 3/8"	
		max. length	37 m	35 m	27 m	

OIL 400 bar

s. 430	8430.5000	without hose *		G 3/8" (f)	G 3/8" (m)	18,0 kg
* Hose reel capacity		inner hose Ø	2 x 5/16"	2 x 3/8"		
		max. length	12 m	10 m		
s. 530	8530.5000	without hose *		G 3/8" (f)	G 3/8" (m)	25,0 kg
* Hose reel capacity		inner hose Ø	2 x 5/16"	2 x 3/8"		
		max. length	20 m	15 m		
s. 540	8540.5000	without hose *		G 3/8" (f)	G 3/8" (m)	30,0 kg
* Hose reel capacity		inner hose Ø	2 x 1/4"	2 x 5/16"	2 x 3/8"	
		max. length	37 m	35 m	27 m	

OIL-WATER 700 bar

s. 430	8430.5500	without hose *		G 3/8" (f)	G 3/8" (m)	18,0 kg
* Hose reel capacity		inner hose Ø	2 x 1/4"	2 x 5/16"	2 x 3/8"	
		max. length	13 m	12 m	10 m	
s. 530	8530.5500	without hose *		G 3/8" (f)	G 3/8" (m)	25,0 kg
* Hose reel capacity		inner hose Ø	2 x 1/4"	2 x 5/16"	2 x 3/8"	
		max. length	22 m	20 m	15 m	
s. 540	8540.5500	without hose *		G 3/8" (f)	G 3/8" (m)	30,0 kg
* Hose reel capacity		inner hose Ø	2 x 1/4"	2 x 5/16"	2 x 3/8"	
		max. length	37 m	35 m	27 m	



**ADVANCED FLUID
MANAGEMENT SOLUTIONS**

SPRING OPERATED ENCLOSED HOSE REELS



EXAMPLES OF USE

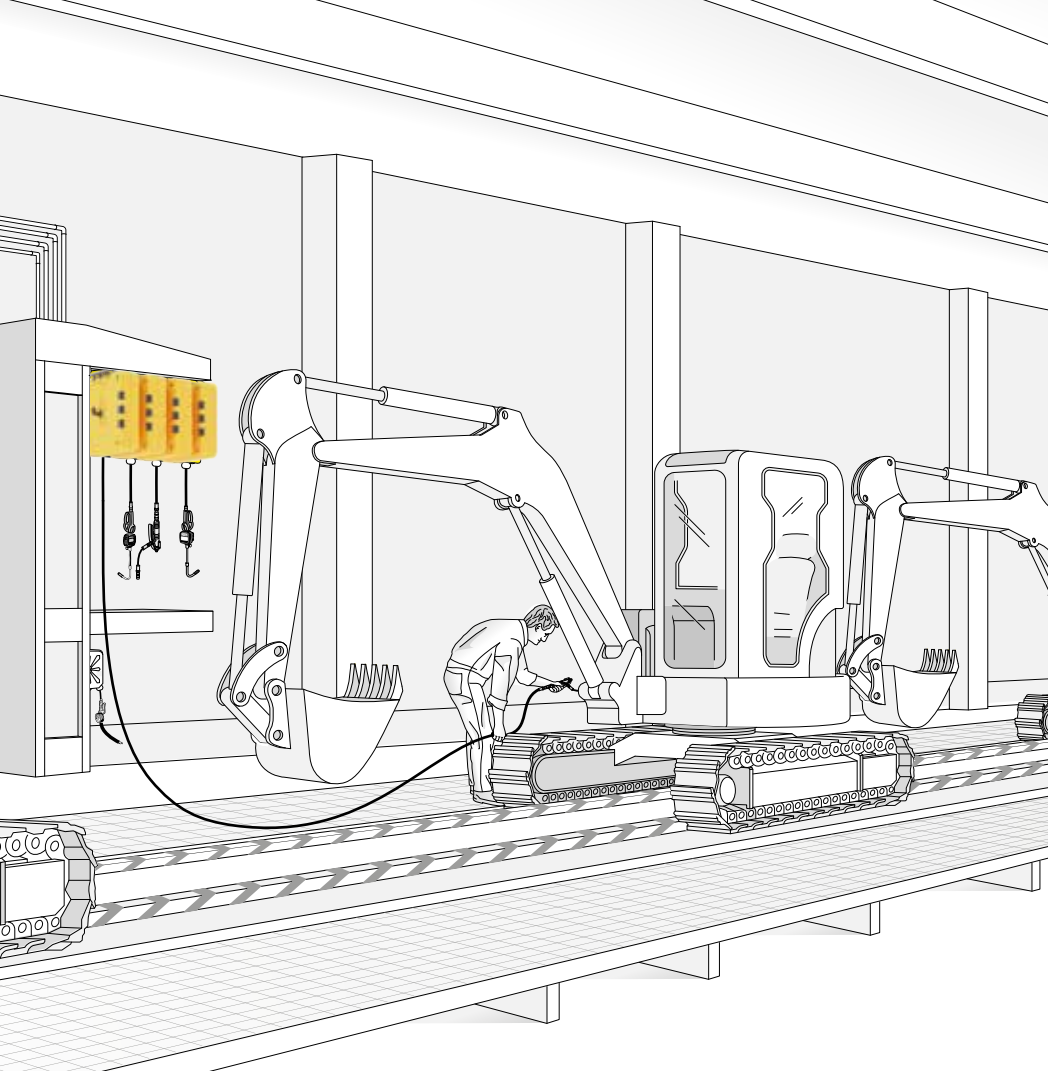

**GREASING EXCAVATORS ON ASSEMBLY LINES
IN-SHOP MAINTENANCE OPERATIONS**

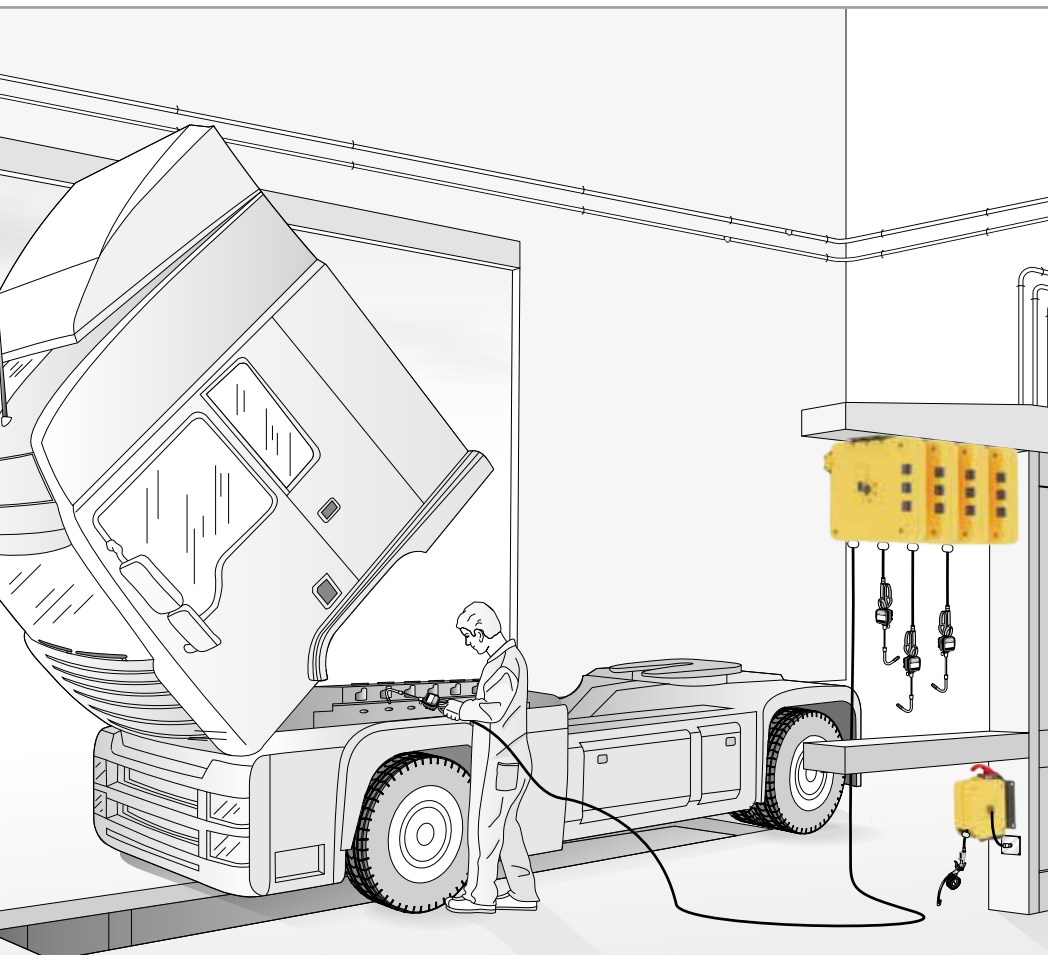

AUTOMOTIVE

LUBE TRUCKS
AND INDUSTRIAL
VEHICLES

MINING
INDUSTRY

BUILDING
AND ROAD
CONSTRUCTION

RAILWAY
TRANSPORT

...and much more



**ADVANCED FLUID
MANAGEMENT SOLUTIONS**

SPRING OPERATED --- **ENCLOSED HOSE REELS**

STRENGTH POINTS

- Repeated spring stress-tests guarantees decades of life and efficiency.
- All models comply with the ATEX directive for use in environments with potentially explosive atmospheres.
- Hose guide with rollers on 4 sides, horizontal and vertical, standard on all models, designed to extend average hose life.
- Hose stop available for all standard models, even those supplied without hose.
- The spring force is both constant and adjustable. Thus use can be fine-tuned to the specific needs of each application.
- All sliding parts, such as bushing and the rack, are made of special technopolymers tested for long-term use.

TECHNICAL CHARACTERISTICS

Visit our
website



FIXING BRACKET

Has 4 slotted holes for safe, easy installation.

PAWL

Easy to remove for maintenance or when the work requires free sliding.

STOP RACK

Makes it possible to lock the hose around every 0,5 m.

SPRING

Tested to withstand over 20000 work cycles.

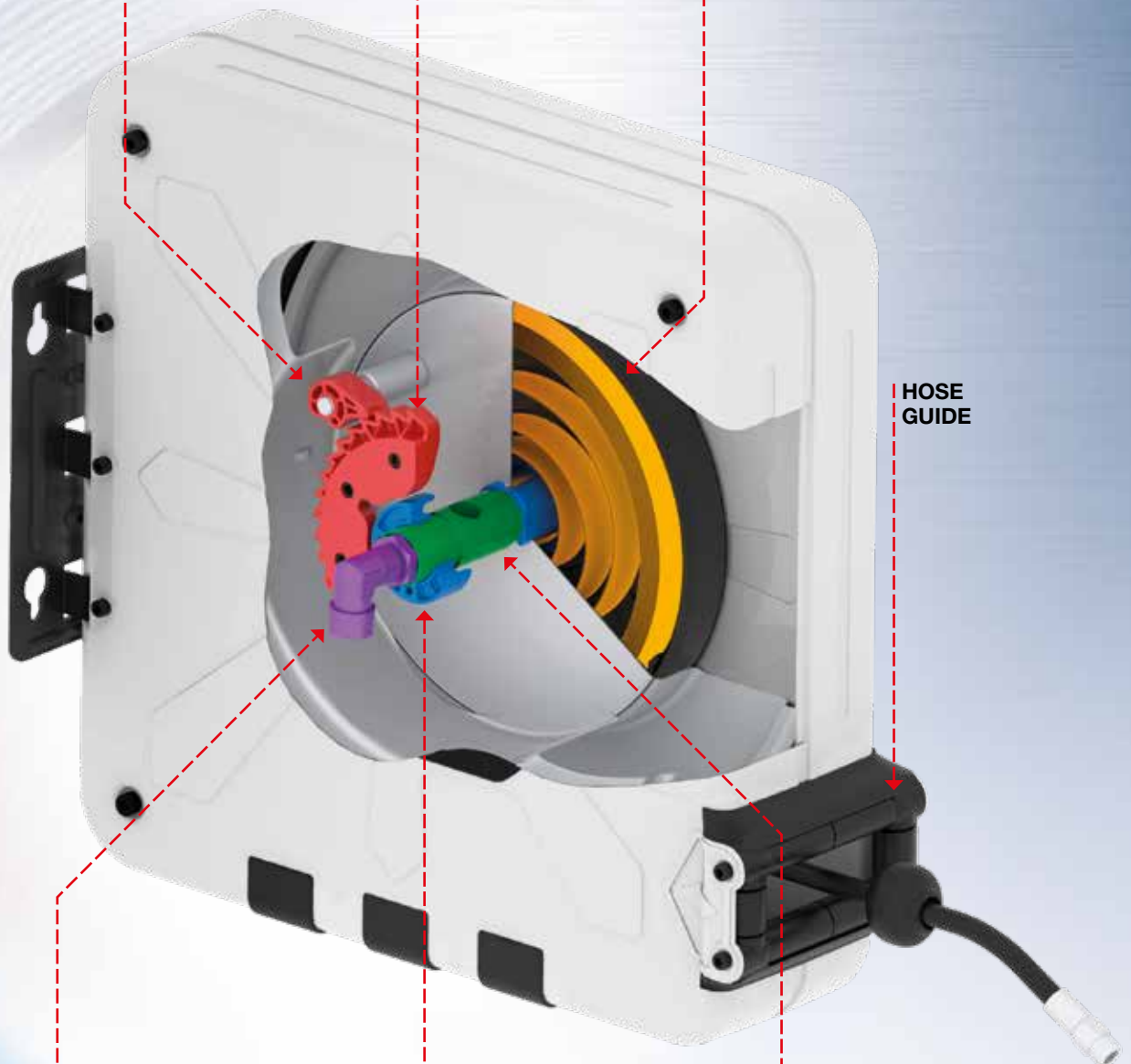

HOSE GUIDE

SWIVEL JOINT

Designed to minimise load losses. Available in different materials to ensure maximum chemical compatibility with a wide range of fluids.

DRUM SUPPORT BUSHING

Made of self-lubricating technopolymer with excellent corrosion resistance.

CENTRAL PIN

Designed to minimise load losses. Available in different materials to ensure maximum chemical compatibility with a wide range of fluids.



Hose reel
ENCLOSED

Pressure
**20-150
400-600 bar**

Material
**- PAINTED STEEL
- ABS**

WITH SPRING



FIXED*

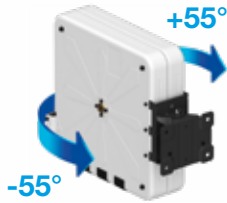

SWIVELLING

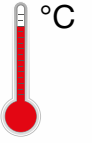

- with hose, see page 139
- without hose:
with brass swivel joint
max. 100 °C
with galvanized steel
swivel joint max. 80 °C



In accordance with directive







for ABS and enclosed
models 20 bar

* can be rendered swivelling by using the
special bracket, see page 81.

Enclosed hose reels are used for the following fluids:

	Hoses	Connections	Seals	Swivel joint	Central pin
AIR-WATER 20 bar	black rubber	galvanized steel	Viton®	brass	galvanized steel
OIL AND SIMILAR 150 bar	black rubber	galvanized steel	polyurethane	galvanized steel	galvanized steel
FOR SUCTION OF OIL AND SIMILAR	black rubber	galvanized steel	Viton®	brass	galvanized steel
GREASE 400-600 bar	black rubber	galvanized steel	polyurethane	galvanized steel	galvanized steel

COVER COLOURS

Painted

Overall dimensions (mm)		Series 450	A	B	C	D	E	F	G	H	I	Packaging (mm) W x D x H	
	FIXED	217	177	180	236	217	140	485	495	485		620 x 290 x 620	
	SWIVEL.	208	162	118	164	208	140	485	575	485		620 x 290 x 620	

(W: width - D: depth - H: height)

P/N		Hose supplied	Connection		Weight	
fixed	swivelling		inlet	outlet	fixed	swivelling

AIR-WATER 20 bar

s. 450	8450.100	8440.100	without hose *	G 1/2" (f)	G 1/2" (f)	22,2 kg	23,0 kg
	8450.101	8440.101	12 m - 3/8" (995.212)	G 1/2" (f)	G 3/8" (m)	24,7 kg	25,5 kg
	8450.102	8440.102	18 m - 3/8" (995.218)	G 1/2" (f)	G 3/8" (m)	25,4 kg	26,2 kg
	8450.103	8440.103	10 m - 1/2" (996.210)	G 1/2" (f)	G 1/2" (m)	25,2 kg	26,0 kg
	8450.104	8440.104	15 m - 1/2" (996.215)	G 1/2" (f)	G 1/2" (m)	26,1 kg	26,9 kg

* Hose reel capacity	inner hose Ø	5/16"	3/8"	1/2"
	max. length	20 m	20 m	16 m

s. 450 ABS drum	9450.100	-	without hose *	G 1/2" (f)	G 1/2" (f)	19,5 kg	-
	9450.101	-	12 m - 3/8" (995.212)	G 1/2" (f)	G 3/8" (m)	22,0 kg	-
	9450.102	-	18 m - 3/8" (995.218)	G 1/2" (f)	G 3/8" (m)	22,7 kg	-
	9450.103	-	10 m - 1/2" (996.210)	G 1/2" (f)	G 1/2" (m)	22,5 kg	-
	9450.104	-	15 m - 1/2" (996.215)	G 1/2" (f)	G 1/2" (m)	23,4 kg	-

* Hose reel capacity	inner hose Ø	5/16"	3/8"	1/2"
	max. length	20 m	20 m	16 m

OIL AND SIMILAR 150 bar

s. 450	8450.400	8440.400	without hose *	G 1/2" (f)	G 1/2" (f)	22,2 kg	23,0 kg
	8450.401	8440.401	10 m - 1/2" (996.310)	G 1/2" (f)	G 1/2" (m)	26,4 kg	27,2 kg
	8450.402	8440.402	15 m - 1/2" (996.315)	G 1/2" (f)	G 1/2" (m)	28,4 kg	29,2 kg

* Hose reel capacity	inner hose Ø	5/16"	3/8"	1/2"
	max. length	20 m	20 m	16 m

s. 450 ABS drum	9450.400	-	without hose *	G 1/2" (f)	G 1/2" (f)	19,5 kg	-
	9450.401	-	10 m - 1/2" (996.310)	G 1/2" (f)	G 1/2" (m)	23,7 kg	-
	9450.402	-	15 m - 1/2" (996.315)	G 1/2" (f)	G 1/2" (m)	25,7 kg	-

* Hose reel capacity	inner hose Ø	5/16"	3/8"	1/2"
	max. length	20 m	20 m	16 m

FOR SUCTION OF OIL AND SIMILAR

s. 450 for suction	8450.401/AS	8440.401/AS	10 m - 1/2" (996.310)	G 1/2" (f)	G 1/2" (m)	27,0 kg	27,8 kg
-------------------------------	--------------------	--------------------	-----------------------	------------	------------	---------	---------

* Hose reel capacity	inner hose Ø	5/16"	3/8"	1/2"
	max. length	10 m	10 m	10 m

GREASE 400-600 bar

s. 450 600 bar	8450.500	8440.500	without hose *	G 3/8" (f)	G 1/2" (f)	22,2 kg	23,0 kg
s. 450 400 bar	8450.501	8440.501	12 m - 1/4" (993.512)	G 3/8" (f)	G 1/4" (m)	25,9 kg	26,7 kg
	8450.502	8440.502	18 m - 1/4" (993.518)	G 3/8" (f)	G 1/4" (m)	27,6 kg	28,4 kg
	8450.505	8440.505	10 m - 3/8" (995.710)	G 3/8" (f)	G 1/4" (m)	26,8 kg	27,6 kg
	8450.506	8440.506	15 m - 3/8" (995.715)	G 3/8" (f)	G 1/4" (m)	28,6 kg	29,4 kg

* Hose reel capacity	inner hose Ø	5/16"	3/8"
	max. length	12 m	15 m

s. 450 ABS drum 600 bar	9450.500	-	without hose *	G 3/8" (f)	G 1/2" (f)	19,5 kg	-
s. 450 ABS drum 400 bar	9450.501	-	12 m - 1/4" (993.512)	G 3/8" (f)	G 1/4" (m)	23,2 kg	-
	9450.502	-	18 m - 1/4" (993.518)	G 3/8" (f)	G 1/4" (m)	24,9 kg	-
	9450.505	-	10 m - 3/8" (995.710)	G 3/8" (f)	G 1/4" (m)	24,1 kg	-
	9450.506	-	15 m - 3/8" (995.715)	G 3/8" (f)	G 1/4" (m)	25,9 kg	-

* Hose reel capacity	inner hose Ø	5/16"	3/8"	1/2"
	max. length	20 m	20 m	16 m





**ADVANCED FLUID
MANAGEMENT SOLUTIONS**

SPRING OPERATED --- HOSE REELS WITH POLYURETHANE HOSE



EXAMPLES OF USE

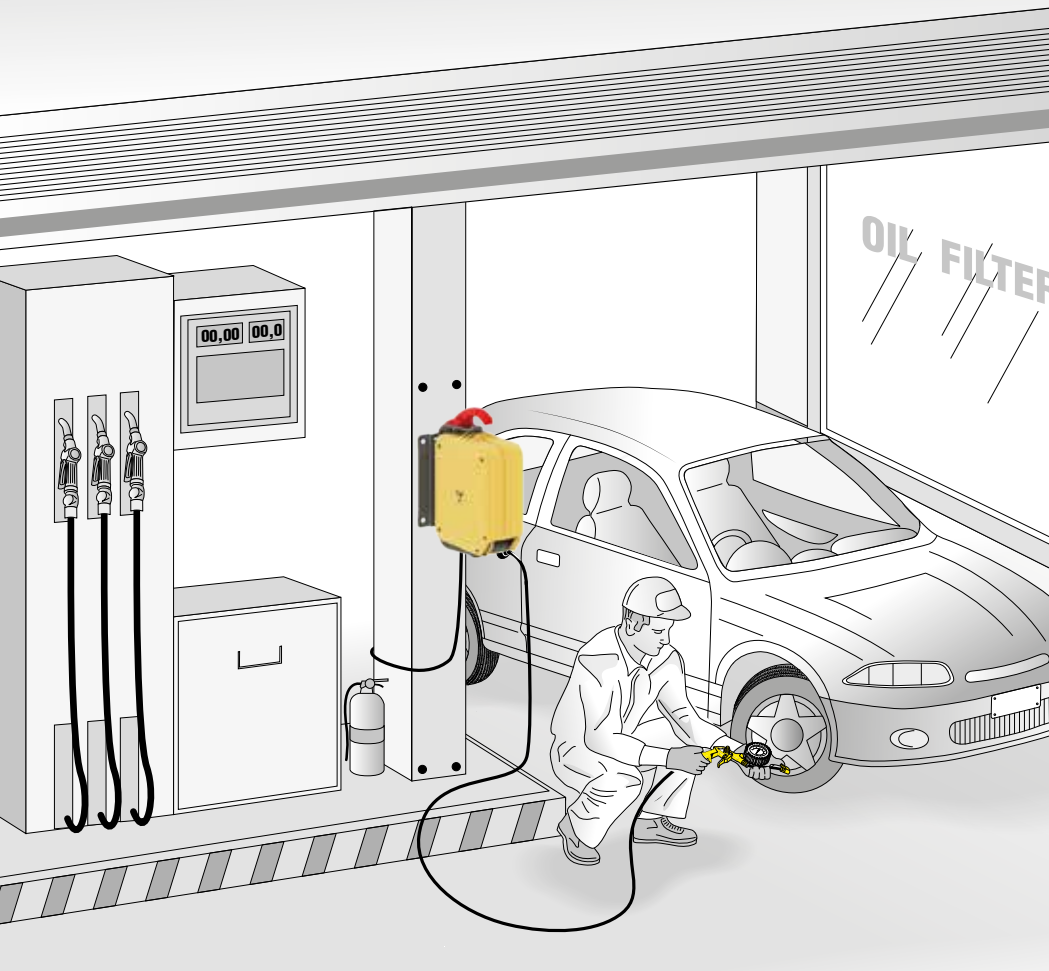

RESTORE OPERATING PRESSURE IN SERVICE STATIONS

**POWERING PNEUMATIC EQUIPMENT
AT MANUFACTURING SITES**

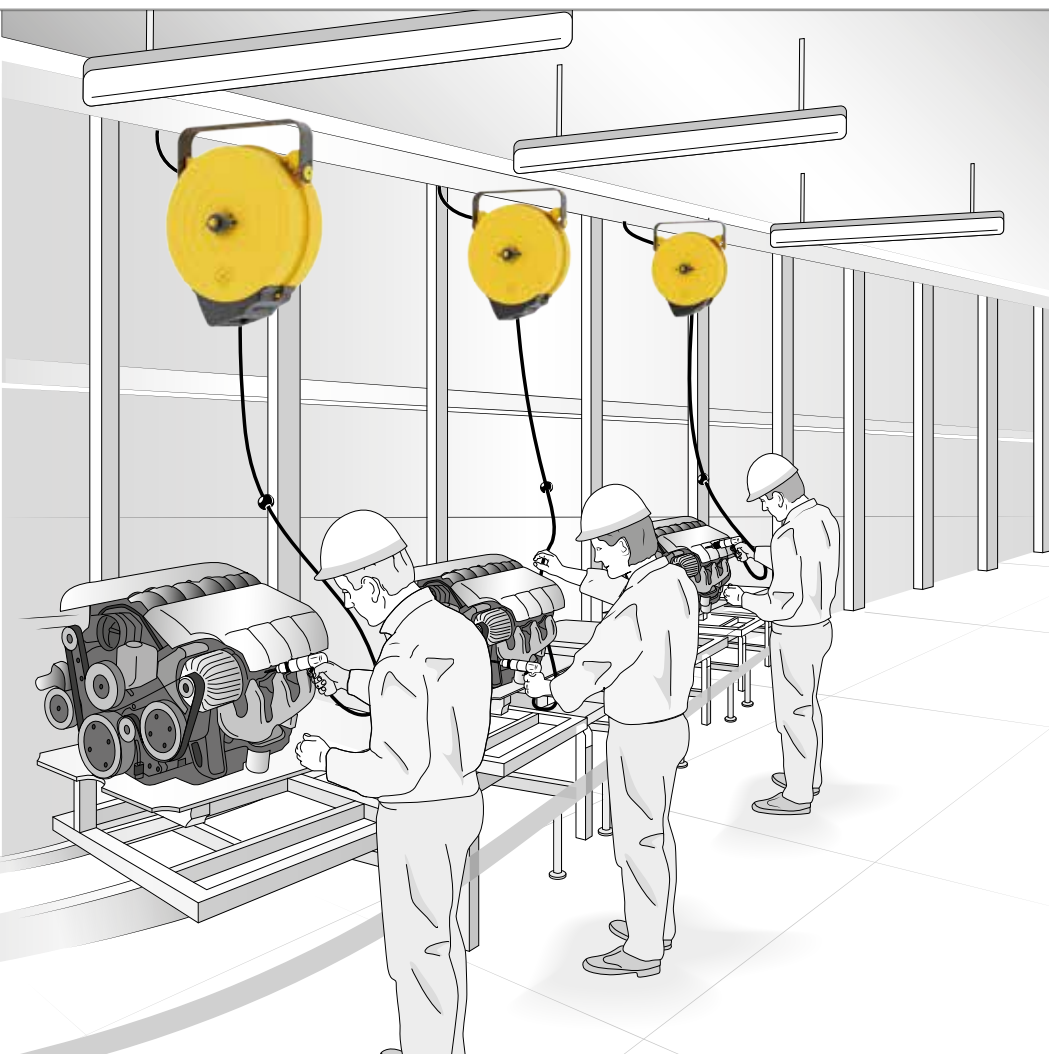

AUTOMOTIVE

CLEANING

SHIPPING AND
OFFSHORE

MANUFACTUR-
ING INDUSTRY

BUILDING
AND ROAD
CONSTRUCTION

...and much more



**ADVANCED FLUID
MANAGEMENT SOLUTIONS**

SPRING OPERATED HOSE REELS WITH POLYURETHANE HOSE

✓ STRENGTH POINTS

- Repeated spring stress-tests guarantees decades of life and efficiency.
- All models comply with the ATEX directive for use in environments with potentially explosive atmospheres.
- Hose stop available for all standard models, even those supplied without hose.
- The spring force is both constant and adjustable. Thus use can be fine-tuned to the specific needs of each application.
- All sliding parts, such as bushing and the rack, are made of special technopolymers tested for long-term use.
- Light, resistant polyurethane hose with metal spiral tips to safeguard durability and integrity.

TECHNICAL CHARACTERISTICS

Visit our
website



FIXING BRACKET

Has 4 slotted holes for safe, easy installation.

PAWL

Easy to remove for maintenance or when the work requires free sliding.

STOP RACK

Makes it possible to lock the hose around every 0,5 m.

SPRING

Tested to withstand over 20000 work cycles.

MULTI POSITION ARMS

Hose outlet position can be changed manually by modifying the installation of the arms.

HOSE GUIDE

Designed with ample width and roller arrangement to reduce wear on the hose.

DRUM SUPPORT BUSHING

Made of self-lubricating technopolymer with excellent wear and corrosion resistance.

CENTRAL PIN

Designed to minimise load losses.

SWIVEL JOINT

Designed to minimise load losses. Available in different materials to ensure maximum chemical compatibility with a wide range of fluids.

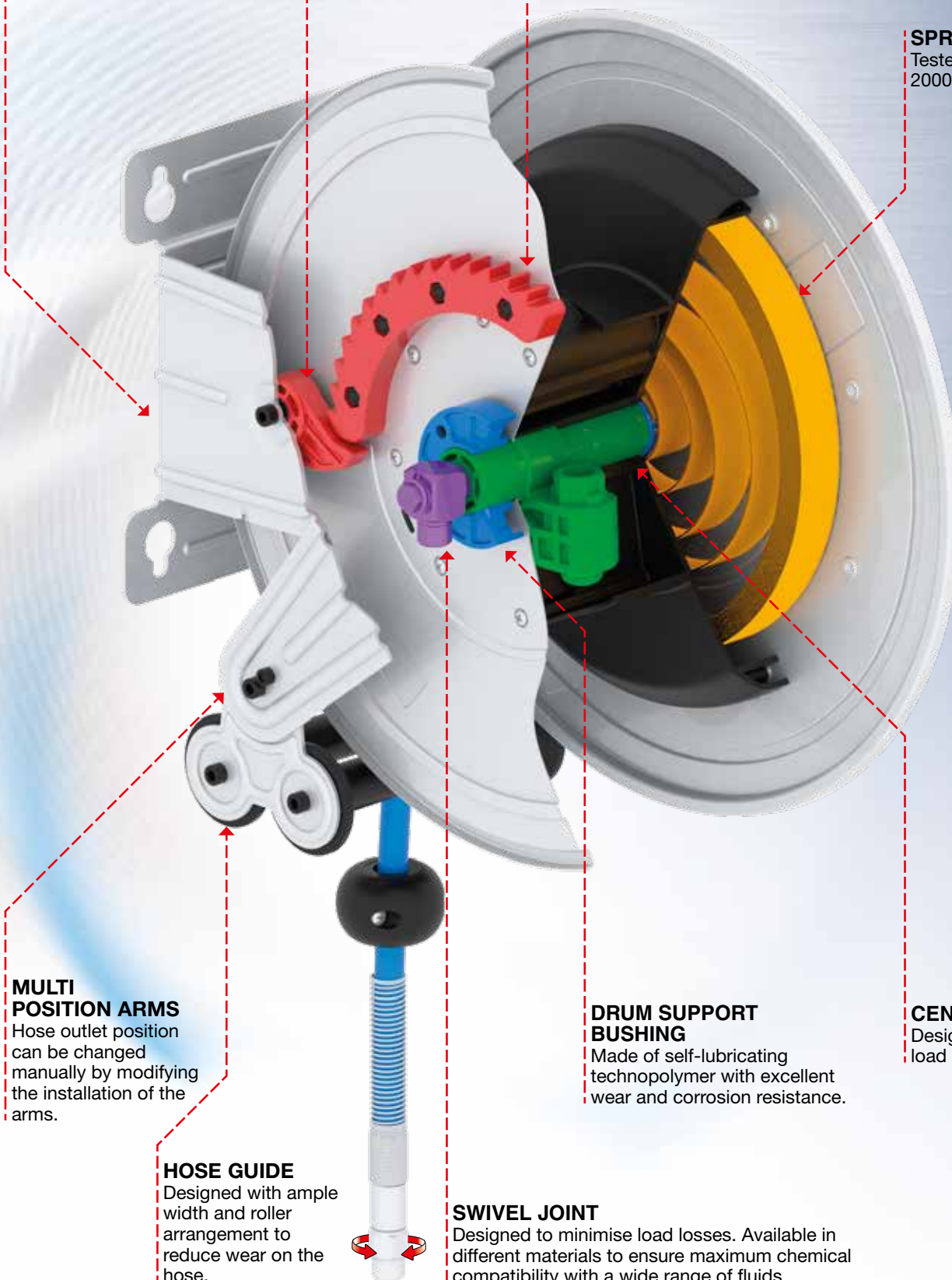



Type of fluid
AIR-WATER

Pressure
20 bar

Material
- PAINTED STEEL
- ABS

WITH SPRING



FIXED*

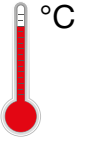





Max. temperature 70 °C



In accordance with directive





* can be rendered swivelling (except for s. 250) by using the special bracket, see page 81.

	Hoses	Connections	Seals	Swivel joint	Central pin
S. 250	Atoxic polyurethane	brass	Viton®	Delrin® - brass	Delrin®
S. 290-330-390				brass	nylon PA6
S. 430				brass	galvanized steel
					

DRUM COLOURS

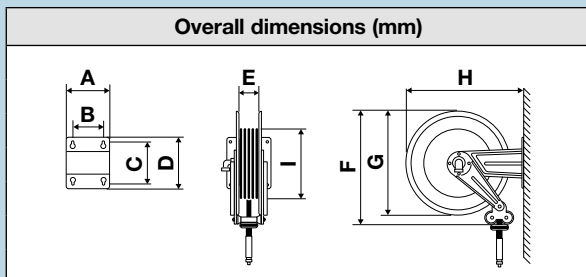
Painted    



Series	A	B	C	D	E	F	G	H	I	Packaging (mm) W x D x H
250	186	140	196	225	90	-	255	282	110	 330 x 200 x 300
290	186	140	196	226	98	330	300	339	135	470 x 260 x 490
330	186	140	196	226	98	390	350	365	155	510 x 260 x 520
390	186	140	196	226	98	410	390	410	155	580 x 280 x 590
430	186	140	196	226	115	450	420	460	261	580 x 280 x 590

(W: width - D: depth - H: height)

P/N	Hose supplied	Connection		Weight
		inlet	outlet	

s. 250 ABS	HOSE REEL FOR SERVICE COLUMNS WITH STEEL BRACKET AND ABS DRUM				
	92438.101	12 m - 8 x 12 mm (971.112)	G 3/8" (m)	G 1/4" (m)	7,6 kg
	92438.102	10 m - 10 x 14,5 mm (972.110)	G 3/8" (m)	G 3/8" (m)	7,8 kg

Hose guide available as accessory, see page 83

s. 290	8288.100	without hose *	G 3/8" (m)	G 3/8" (f)	9,5 kg
	8288.102	13 m - 10 x 14,5 mm (972.113)	G 3/8" (m)	G 3/8" (m)	11,3 kg
	8288.103	15 m - 8 x 12 mm (971.115)	G 3/8" (m)	G 1/4" (m)	11,0 kg
	8288.104	10 m - 6 x 10 mm (971.010)	G 3/8" (m)	G 1/4" (m)	10,5 kg
	8288.105	15 m - 6 x 10 mm (971.015)	G 3/8" (m)	G 1/4" (m)	10,9 kg

* Hose reel capacity	inner hose Ø	8 x 12	10 x 14,5
	max. length	16 m	14 m

s. 330	8328.100	without hose *	G 3/8" (m)	G 3/8" (f)	10,1 kg
	8328.102	15 m - 10 x 14,5 mm (972.115)	G 3/8" (m)	G 3/8" (m)	12,1 kg
	8328.103	18 m - 8 x 12 mm (971.118)	G 3/8" (m)	G 1/4" (m)	11,8 kg
	8328.104	8 m - 13 x 19 mm (976.108)	G 1/2" (m)	G 1/2" (m)	12,0 kg
	8328.105	12 m - 13 x 19 mm (976.112)	G 1/2" (m)	G 1/2" (m)	15,9 kg

* Hose reel capacity	inner hose Ø	8 x 12	10 x 14,5	13 x 19
	max. length	18 m	16 m	12 m

s. 390	8378.100	without hose *	G 3/8" (m)	G 3/8" (f)	13,5 kg
	8378.102	20 m - 10 x 14,5 mm (972.120)	G 3/8" (m)	G 3/8" (m)	18,2 kg
	8378.103	20 m - 8 x 12 mm (971.120)	G 3/8" (m)	G 1/4" (m)	15,4 kg
	8378.104	10 m - 13 x 19 mm (976.110)	G 1/2" (m)	G 1/2" (m)	16,6 kg
	8378.105	15 m - 13 x 19 mm (976.114)	G 1/2" (m)	G 1/2" (m)	17,0 kg

* Hose reel capacity	inner hose Ø	8 x 12	10 x 14,5	13 x 19
	max. length	18 m	16 m	12 m

s. 430	8430.100	without hose *	G 1/2" (f)	G 1/2" (f)	15,2 kg
	8438.101	10 m - 13 x 19 mm (976.111)	G 1/2" (f)	G 1/2" (m)	18,3 kg
	8438.102	15 m - 13 x 19 mm (976.115)	G 1/2" (f)	G 1/2" (m)	18,9 kg

* Hose reel capacity	inner hose Ø	10 x 14,5	13 x 19	16 x 27
	max. length	20 m	16 m	14 m





**ADVANCED FLUID
MANAGEMENT SOLUTIONS**

SPRING OPERATED HOSE REELS WITH TECHNOPOLYMER COVER AND POLYURETHANE HOSE

✓ STRENGTH POINTS

- Comes standard with polyurethane hose that can be used with aqueous or detergent solutions at up to 70 °C.
- Hose guide with rollers, horizontal and vertical, on 4 sides, designed to extend average hose life, as standard on all models.
- The hose reel comes with a 1,5 m section of hose for connection to the fixed system.
- The standard swivelling bracket, with slotted fixing holes, has special seals that act as a clutch. The bracket can also be locked in the upright position or rotated 90°.
- An optional rewind clutch is available, useful to protect against accidental, uncontrolled rewinding of the hose.
- An optional bayonet bracket, which lets you quickly move the hose reel around the various workstations, is also available.

TECHNICAL CHARACTERISTICS

Visit our website



PAWL

Easy to remove for maintenance or when the work requires free sliding.

REWINDING CLUTCH

Optional: lets you rewind the drum at a safe speed.

SPRING

Tested to withstand over 20000 work cycles.

SIDE CLUTCH

BAYONET BRACKET

Lets you quickly move the hose reel around the various workstations.

HOSE GUIDE

CONNECTIONS AND CENTRAL PIN

Designed to minimise load losses. Available in different materials to ensure maximum chemical compatibility with a wide range of fluids.

STOP RACK

Makes it possible to lock the hose every 0,5 m.

FIXING BRACKET

Can be rotated up to 90° per side and has 2 slotted holes for safe, easy installation.

ENTRY JOINT

Can be oriented in 8 different positions, evenly spaced by 45°, to facilitate connection to the fixed system.

HOSE

Fit with hose stop and metal spiral tips to reinforce the hose structure.

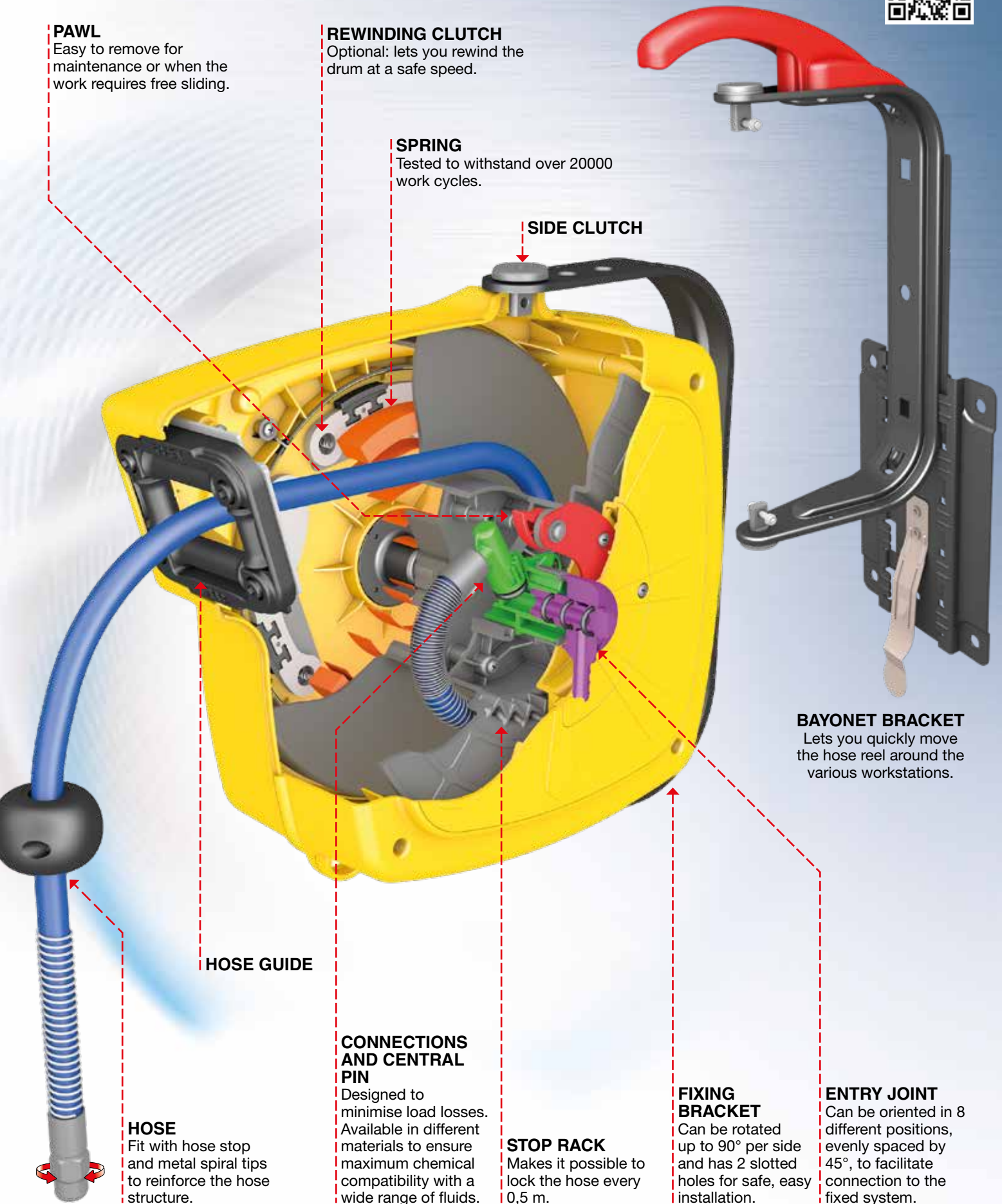



Type of fluid
AIR-WATER

Pressure
20 bar

Material
TECHNOPOLYMER

WITH SPRING

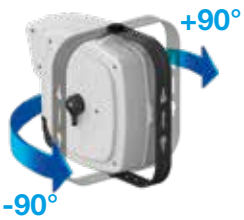

SWIVELLING

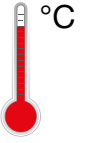

Max. temperature 70 °C



COVER COLOURS

ABS s. 260

Polypropylene s. 280



	Hoses	Connections	Seals	Swivel joint	Central pin
s. 260	Atoxic polyurethane	brass	Viton®	brass	galvanized steel
s. 280				brass	Delrin®

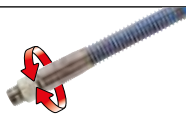

Overall dimensions (mm) with bayonet hooking s. 260

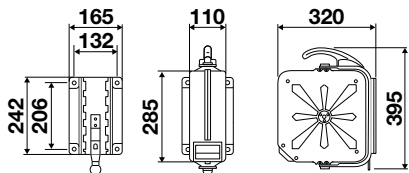

Packaging (mm)
W 470 x D 260 x H 490

Overall dimensions (mm) with bayonet hooking s. 280

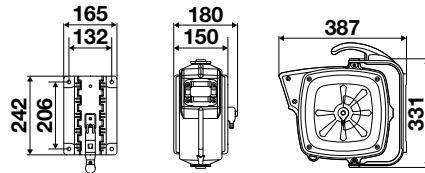

Packaging (mm)
W 470 x D 260 x H 490

Overall dimensions (mm) without bayonet hooking s. 260

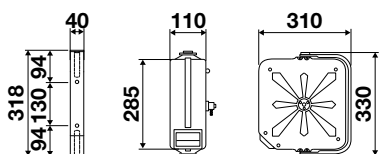

Packaging (mm)
W 470 x D 260 x H 490

Overall dimensions (mm) without bayonet hooking s. 280

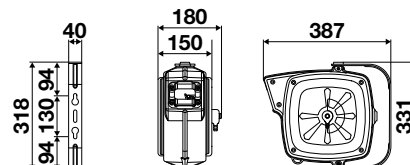

Packaging (mm)
L 470 x P 260 x H 490

(W: width - D: depth - H: height)



P/N	Hose supplied	Connection		Weight
		inlet	outlet	

WITH SWIVELLING WALL MOUNTED BRACKET WITH BAYONET HOOKING

s. 260	89010	11 m - 8 x 12 mm (971.111)	G 1/4" (m)	G 1/4" (m)	6,5 kg
	89011	11 m - 6 x 10 mm (971.011)	G 1/4" (m)	G 1/4" (m)	7,3 kg

WITH SWIVELLING WALL MOUNTED BRACKET

s. 260	89109	11 m - 8 x 12 mm (971.111)	G 1/4" (m)	G 1/4" (m)	5,8 kg
	89110	11 m - 6 x 10 mm (971.011)	G 1/4" (m)	G 1/4" (m)	5,6 kg

WITH SWIVELLING WALL MOUNTED BRACKET

s. 280	92808.101	10 m - 8 x 12 mm (971.110)	G 3/8" (m)	G 1/4" (m)	8,2 kg
	92808.102	14 m - 8 x 12 mm (971.114)	G 3/8" (m)	G 1/4" (m)	8,5 kg
	92808.105	8+1 m - 10 x 14,5 mm (972.109)	G 3/8" (m)	G 3/8" (m)	8,6 kg

WITH SWIVELLING WALL MOUNTED BRACKET AND SPEED CONTROL

s. 280	92848.101	10 m - 8 x 12 mm (971.110)	G 3/8" (m)	G 1/4" (m)	9,0 kg
	92848.102	14 m - 8 x 12 mm (971.114)	G 3/8" (m)	G 1/4" (m)	9,3 kg
	92848.105	8+1 m - 10 x 14,5 mm (972.109)	G 3/8" (m)	G 3/8" (m)	9,4 kg

WITH SWIVELLING WALL MOUNTED BRACKET WITH BAYONET HOOKING

s. 280	92818.101	10 m - 8 x 12 mm (971.110)	G 3/8" (m)	G 1/4" (m)	8,8 kg
	92818.102	14 m - 8 x 12 mm (971.114)	G 3/8" (m)	G 1/4" (m)	9,1 kg
	92818.105	8+1 m - 10 x 14,5 mm (972.109)	G 3/8" (m)	G 3/8" (m)	9,2 kg

WITH SWIVELLING WALL MOUNTED BRACKET WITH BAYONET AND SPEED CONTROL

s. 280	92858.101	10 m - 8 x 12 mm (971.110)	G 3/8" (m)	G 1/4" (m)	9,6 kg
	92858.102	14 m - 8 x 12 mm (971.114)	G 3/8" (m)	G 1/4" (m)	9,9 kg
	92858.105	8+1 m - 10 x 14,5 mm (972.109)	G 3/8" (m)	G 3/8" (m)	10,0 kg



**ADVANCED FLUID
MANAGEMENT SOLUTIONS**

SPRING OPERATED HOSE REELS IN STEEL WITH POLYURETHANE HOSE

✓ STRENGTH POINTS

- Comes standard with polyurethane hose that can be used with aqueous or detergent solutions at up to 70 °C.
- In the versions with stainless steel cover, the hose fittings, spiral protections and swivel joint are supplied as standard in AISI 304 stainless steel.
- All models comply with the ATEX directive for use in environments with potentially explosive atmospheres.
- Hose guide with rollers, horizontal and vertical, on 4 sides, designed to extend average hose life, as standard on all models.
- The hose reel comes with a 1,5 m section of hose for connection to the fixed system.
- The standard swivelling bracket, with slotted fixing holes, has special seals that act as a clutch. The bracket can also be locked in the upright position or rotated 90°.

TECHNICAL CHARACTERISTICS

Visit our website



SPRING

Tested to withstand over 20000 work cycles.

PAWL

ENTRY SWIVEL JOINT

Can be oriented in 8 different positions, evenly spaced by 45°, to facilitate connection to the fixed system.



BAYONET BRACKET

Lets you quickly move the hose reel around the various workstations.

HOSE GUIDE

HOSE

Fit with hose stop and metal spiral tips to reinforce the hose structure.

CENTRAL PIN

Designed to minimise load losses.

STOP RACK

Makes it possible to lock the hose around every 0,5 m.

FIXING BRACKET

Can be rotated up to 90° and has 2 slotted holes for safe, easy installation.

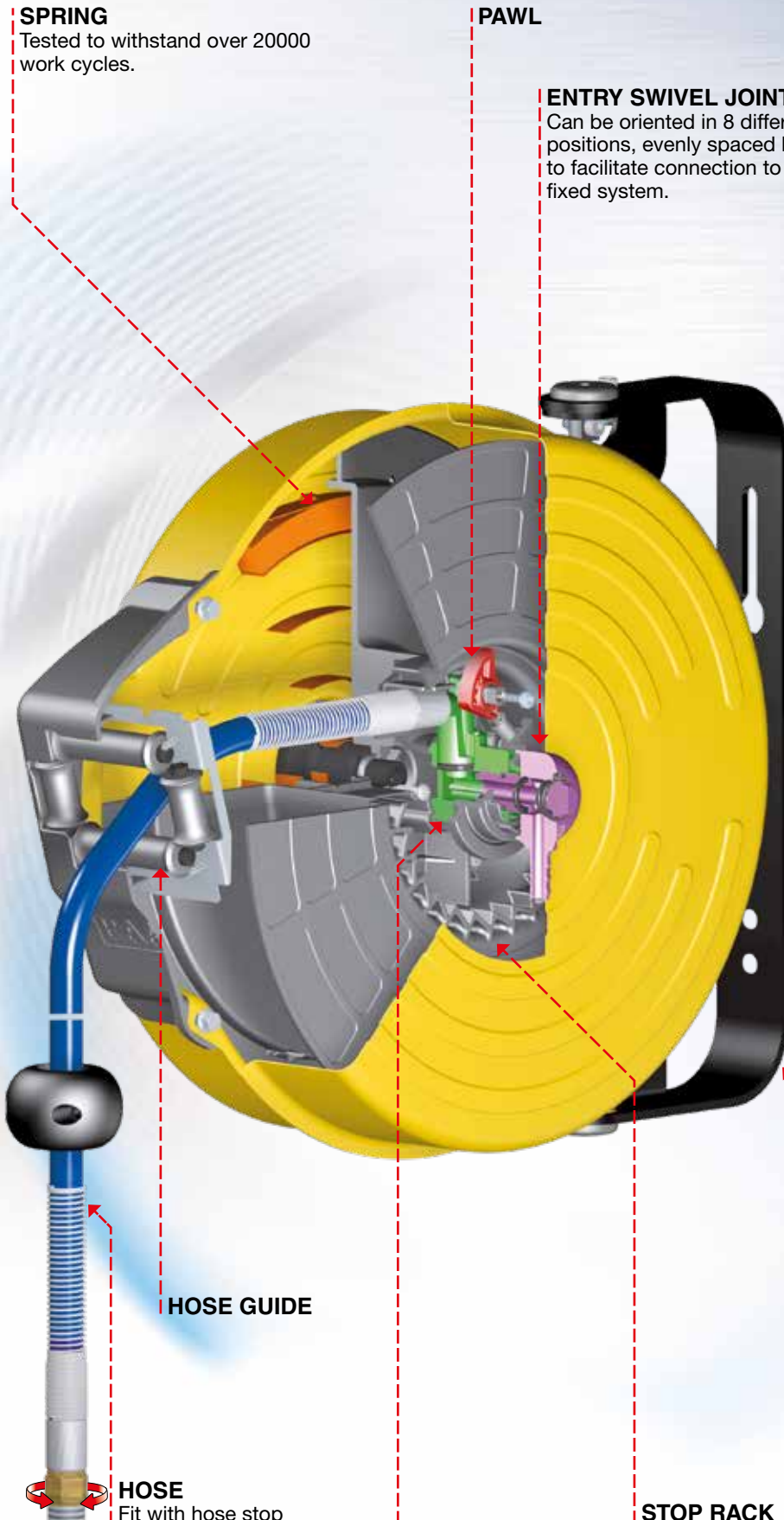



Type of fluid
AIR-WATER

Pressure
20 bar

Material
- PAINTED STEEL
- AISI 304 S. STEEL

WITH SPRING

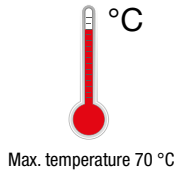

In accordance with directive



COVER COLOURS

Painted

	Hoses	Connections	Seals	Swivel joint	Central pin
Painted steel	Atoxic polyurethane	brass	Viton®	Delrin® - brass	Delrin®
AISI 304 stainless steel	Atoxic polyurethane	AISI 304 stainless steel	Viton®	Delrin® - AISI 304 stainless steel	Delrin®
					

Overall dimensions (mm)	Series	A	B	C	D	E	F	G	H	I	L	M	N	Packaging (mm) W x D x H
	250	40	319	210	130	20	20	173	124	62	281	338	230	
300	40	319	210	130	20	20	173	124	62	333	416	308	 385 x 200 x 415	

(W: width - D: depth - H: height)

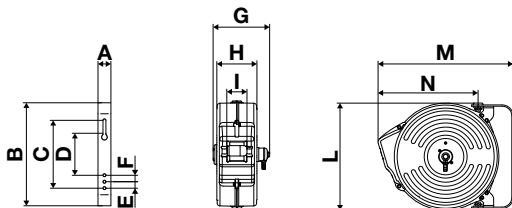



P/N	Hose supplied	Connection		Weight
		inlet	outlet	

PAINTED STEEL

s. 250	92608.101	12 m - 8 x 12 mm (971.112)	G 3/8" (m)	G 1/4" (m)	7,0 kg
	92608.102	10 m - 10 x 14,5 mm (972.110)	G 3/8" (m)	G 3/8" (m)	7,3 kg

s. 300	93108.102	12 m - 8 x 12 mm (971.112)	G 3/8" (m)	G 1/4" (m)	8,6 kg
	93108.103	15 m - 8 x 12 mm (971.116)	G 3/8" (m)	G 1/4" (m)	8,8 kg
	93108.104	20 m - 8 x 12 mm (971.121)	G 3/8" (m)	G 1/4" (m)	9,0 kg
	93108.105	12 m - 10 x 14,5 mm (972.112)	G 3/8" (m)	G 3/8" (m)	8,9 kg
	93108.106	15 m - 10 x 14,5 mm (972.116)	G 3/8" (m)	G 3/8" (m)	9,3 kg

AISI 304 STAINLESS STEEL

s. 250	92708.101	12 m - 8 x 12 mm (981.112)	G 3/8" (m)	G 1/4" (m)	7,0 kg
	92708.102	10 m - 10 x 14,5 mm (982.110)	G 3/8" (m)	G 3/8" (m)	7,3 kg

s. 300	93208.102	12 m - 8 x 12 mm (981.112)	G 3/8" (m)	G 1/4" (m)	8,6 kg
	93208.103	15 m - 8 x 12 mm (981.116)	G 3/8" (m)	G 1/4" (m)	8,8 kg
	93208.104	20 m - 8 x 12 mm (981.121)	G 3/8" (m)	G 1/4" (m)	9,0 kg
	93208.105	12 m - 10 x 14,5 mm (982.112)	G 3/8" (m)	G 3/8" (m)	8,9 kg
	93208.106	15 m - 10 x 14,5 mm (982.116)	G 3/8" (m)	G 3/8" (m)	9,3 kg



**ADVANCED FLUID
MANAGEMENT SOLUTIONS**

Automatic

rewinding





Discover the RAASM rewinding brake
for spring-loaded hose reels...
Contact our offices!



ACCESSORIES - AUTOMATIC HOSE GUIDE IN PAINTED STEEL

The new automatic hose guide guarantees correct arrangement of the hose on the drum, thus preventing haphazard rewinding.

✓ STRENGTH POINTS

- Designed to move independently while rewinding the hose.
- Equipped with rollers, horizontal and vertical, that can be adjusted to the hose being used.
- Easy to assemble on both new hose reels and on equipment already in use.



⚠ The hose reel equipped with automatic hose guide is not suitable for installation in potentially explosive atmosphere.

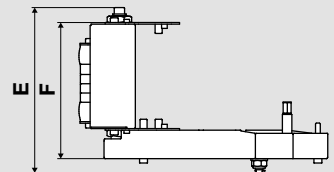
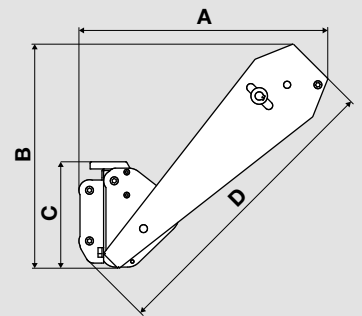

P/N 77/44312

Automatic hose guide in painted steel for hose reel s. 430, hoses up to 1/2".

P/N 77/44601

Automatic hose guide in painted steel for hose reel s. 436, hoses from 3/4" to 1".

P/N 77/44612

Automatic hose guide in painted steel for hose reel s. 436, hoses up to 1/2".

P/N 77/45301

Automatic hose guide in painted steel for hose reel s. 530, hoses up to 1".

P/N 77/45312

Automatic hose guide in painted steel for hose reel s. 530, hoses up to 1/2".

P/N 77/45401

Automatic hose guide in painted steel for hose reel s. 540, hoses up to 3/4".

P/N 77/45402

Automatic hose guide in painted steel for hose reel s. 540, 1" hoses.

P/N 77/45412

Automatic hose guide in painted steel for hose reel s. 540, hoses up to 1/2".

P/N 77/45601

Automatic hose guide in painted steel for hose reel s. 560, hoses up to 3/4".

P/N 77/45602

Automatic hose guide in painted steel for hose reel s. 560, 1" hoses.

P/N 77/45612

Automatic hose guide in painted steel for hose reel s. 560, hoses up to 1/2".

Series	A	B	C	D	E	F
430	314	283	134	377	209	172
530	371	341	136	448	223	187
540	371	341	136	448	288	252
560	371	341	136	448	472	436



ACCESSORIES - AUTOMATIC HOSE GUIDE IN AISI 316 STAINLESS STEEL

The new automatic hose guide guarantees correct arrangement of the hose on the drum, thus preventing haphazard rewinding.

✓ STRENGTH POINTS

- Designed to move independently while rewinding the hose.
- Equipped with rollers, horizontal and vertical, that can be adjusted to the hose being used.
- Easy to assemble on both new hose reels and on equipment already in use.



⚠ The hose reel equipped with automatic hose guide is not suitable for installation in potentially explosive atmosphere.

P/N 79/44312
Automatic hose guide in AISI 316 stainless steel for hose reel s. 430, hoses up to 1/2".

P/N 79/45301
Automatic hose guide in AISI 316 stainless steel for hose reel s. 530, hoses up to 1".

P/N 79/45312
Automatic hose guide in AISI 316 stainless steel for hose reel s. 530, hoses up to 1/2".

P/N 79/45401
Automatic hose guide in AISI 316 stainless steel for hose reel s. 540, hoses up to 3/4".

P/N 79/45402
Automatic hose guide in AISI 316 stainless steel for hose reel s. 540, 1" hoses.

P/N 79/45412
Automatic hose guide in AISI 316 stainless steel for hose reel s. 540, hoses up to 1/2".

P/N 79/45601
Automatic hose guide in AISI 316 stainless steel for hose reel s. 560, hoses up to 3/4".

P/N 79/45602
Automatic hose guide in AISI 316 stainless steel for hose reel s. 560, 1" hoses.

P/N 79/45612
Automatic hose guide in AISI 316 stainless steel for hose reel s. 560, hoses up to 1/2".

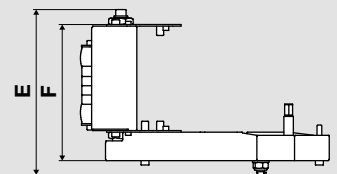
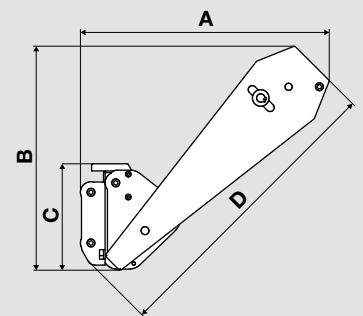

Series	A	B	C	D	E	F
430	314	283	134	377	209	172
530	371	341	136	448	223	187
540	371	341	136	448	288	252
560	371	341	136	448	472	436



ACCESSORIES FOR SPRING OPERATED HOSE REEL

A **quick coupling support**, which facilitates coupling of individual hose reels and optimises installation in series, i.e. several hose reels set side-by-side, is available upon request.

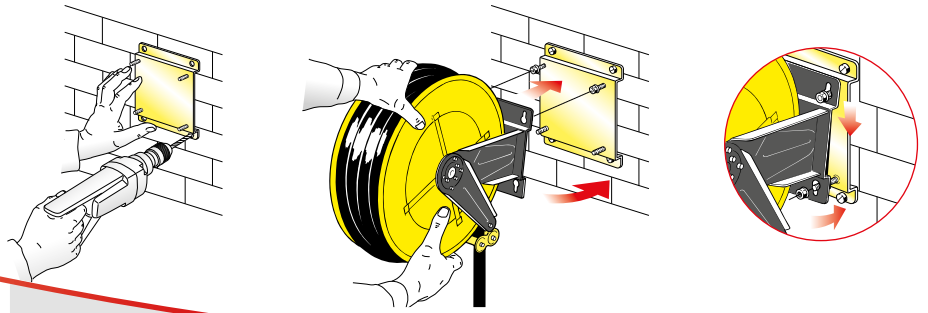

P/N 843001



P/N 843002

P/N 843001

Fixed support in steel

for fixed painted steel hose reels series 290 - 330 - 390 - 430.

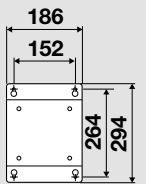

P/N 843002

Fixed support in AISI 304 stainless steel

for fixed hose reels in AISI 304 stainless steel series 290 - 330 - 390 - 430.



P/N 845001

P/N 845001

Fixed support in steel

for fixed enclosed painted steel hose reels series 450.

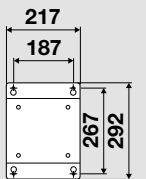

P/N 853001



P/N 853002

P/N 853001

Fixed support in steel

for fixed painted steel hose reels series 530.

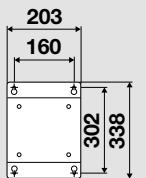

P/N 853002

Fixed support in AISI 304 stainless steel

for fixed hose reels in AISI 304 stainless steel series 530.



P/N 854001



P/N 854002

P/N 854001

Fixed support in steel

for fixed painted steel hose reels series 540.

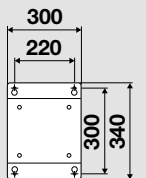

P/N 854002

Fixed support in AISI 304 stainless steel

for fixed hose reels in AISI 304 stainless steel series 540.



P/N 856001



P/N 856002

P/N 856001

Fixed support in steel

for fixed painted steel hose reels series 560.

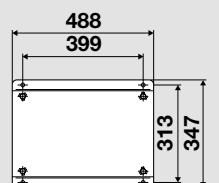

P/N 856002

Fixed support in AISI 304 stainless steel

for fixed hose reels in AISI 304 stainless steel series 560.

A swivelling bracket with quick coupling is available upon request to facilitate hose reel installation in various positions - turned 40° to the right or left, or in the fixed 0° position - by locking it with two screws.

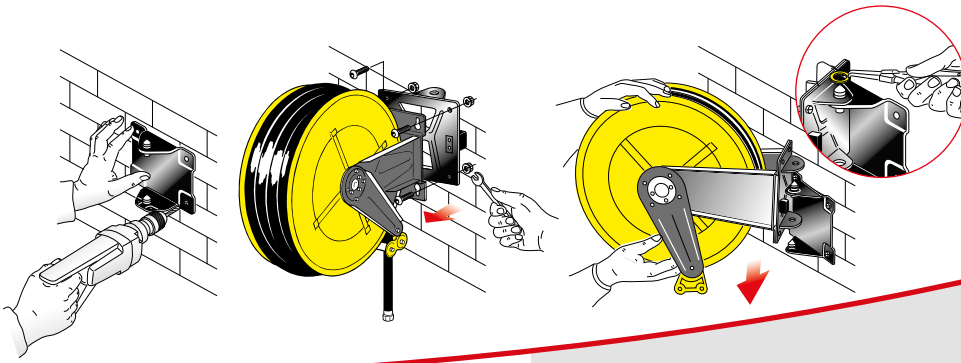

P/N 843005



P/N 843006
P/N 843007



P/N 845005



P/N 853005



P/N 853006
P/N 853007



P/N 854005
P/N 856005



P/N 854006
P/N 854007
P/N 856007

P/N 843005

Swivelling bracket in steel
for fixed hose reels in painted steel
series 290 - 330 - 390 - 430.

P/N 843006

Swivelling bracket in AISI 304 stainless steel
for fixed hose reels in AISI 304 stainless steel
series 290 - 330 - 390 - 430.

P/N 843007

Swivelling bracket in AISI 316 stainless steel
for fixed hose reels in AISI 316 stainless steel
series 290 - 330 - 390 - 430.

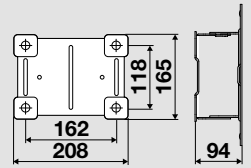

P/N 845005

Swivelling bracket in steel
for fixed enclosed painted steel hose reels,
series 450.

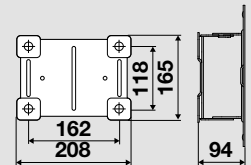

P/N 853005

Swivelling bracket in steel
for fixed hose reels in painted steel series 530.

P/N 853006

Swivelling bracket in AISI 304 stainless steel
for fixed hose reels in AISI 304 stainless steel series 530.

P/N 853007

Swivelling bracket in AISI 316 stainless steel
for fixed hose reels in AISI 316 stainless steel
series 530 - 537.

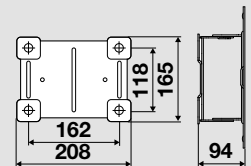

P/N 854005

Swivelling bracket in steel
for fixed hose reels in painted steel series 540.

P/N 856005

Swivelling bracket in steel
for fixed hose reels in painted steel series 560.

P/N 854006

Swivelling bracket in AISI 304 stainless steel
for fixed hose reels in stainless steel and
AISI 304 stainless steel series 540.

P/N 854007

Swivelling bracket in AISI 316 stainless steel
for fixed hose reels in AISI 316 stainless steel
series 540.

P/N 856007

Swivelling bracket in AISI 316 stainless steel
for fixed hose reels in AISI 316 stainless steel
series 560.

**OVERALL
DIMENSIONS
for series 540**

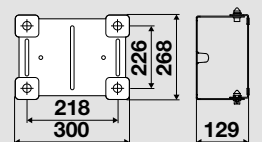

**OVERALL
DIMENSIONS
for series 560**

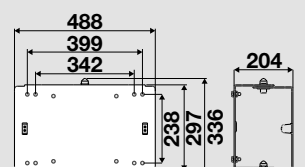



ACCESSORIES FOR FIXED ENCLOSED PAINTED STEEL HOSE REELS

BRACKETS FOR BEAM MOUNTING

This special bracket is used to install 1, 2 or 3 hose reels (s. 390 and 430) on HEA ceiling beams. It can be installed and used in two different positions, turned 90° as shown in the figure to the side.

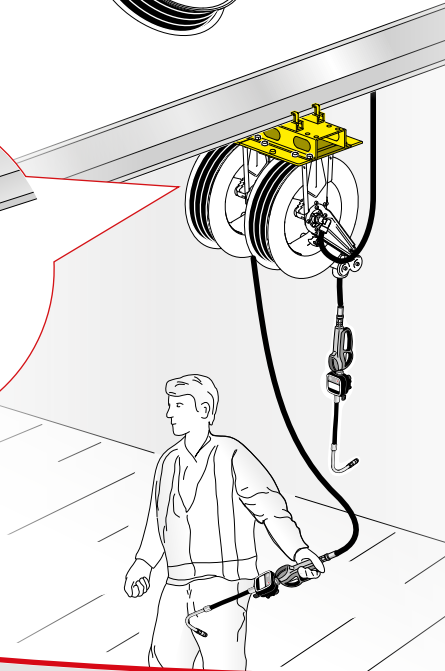
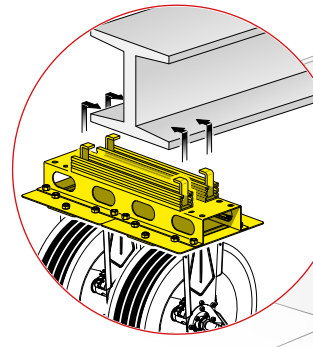
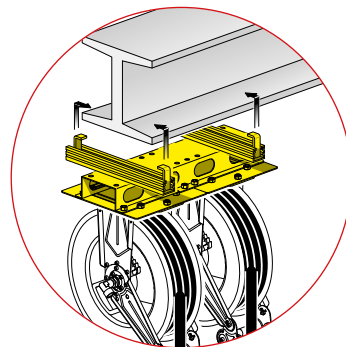
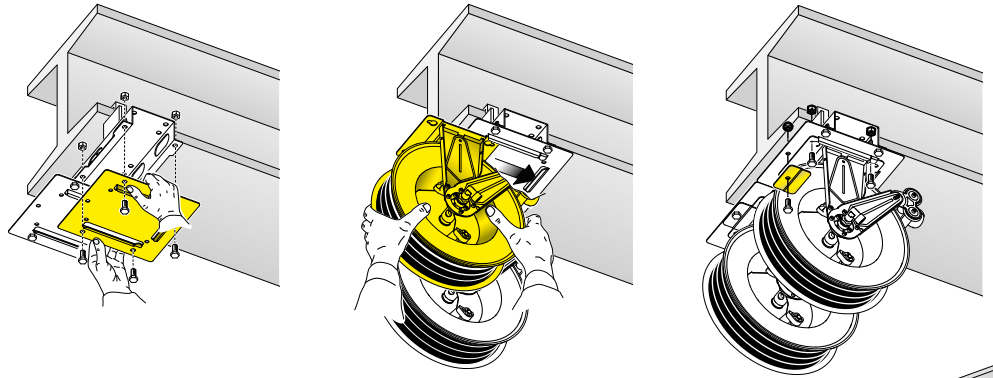

P/N 843011
Bracket for installing 1 hose reel
s. 390 or 430 on HEA beam.

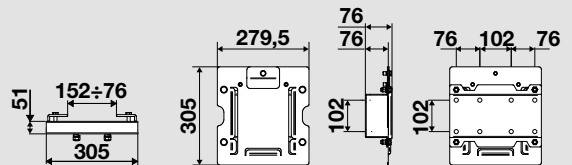

P/N 843012
Bracket for installing 2 hose reels
s. 390 or 430 on HEA beam.

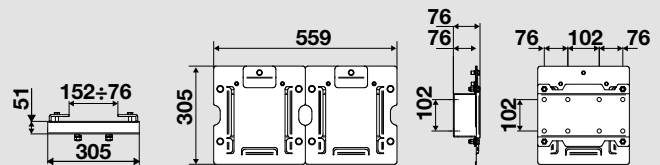

P/N 843013
Bracket for installing 3 hose reels
s. 390 or 430 on HEA beam.

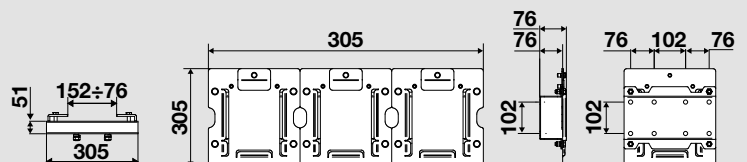

P/N 89003

Bayonet bracket - for enclosed hose reels s. 260 - 280:

lets you easily move cable reel and hose reel around the various workstations.

P/N 89002

Wall support with adaptor for bayonet hooking - for hose reels s. 250 - 300

P/N 89001

Wall support with bayonet hooking - for enclosed hose reels s. 260 - 280

Installing several supports (see drawing) at the points of use lets you easily move the hose reel around the various workstations.



P/N 89003



P/N 89002



P/N 89001

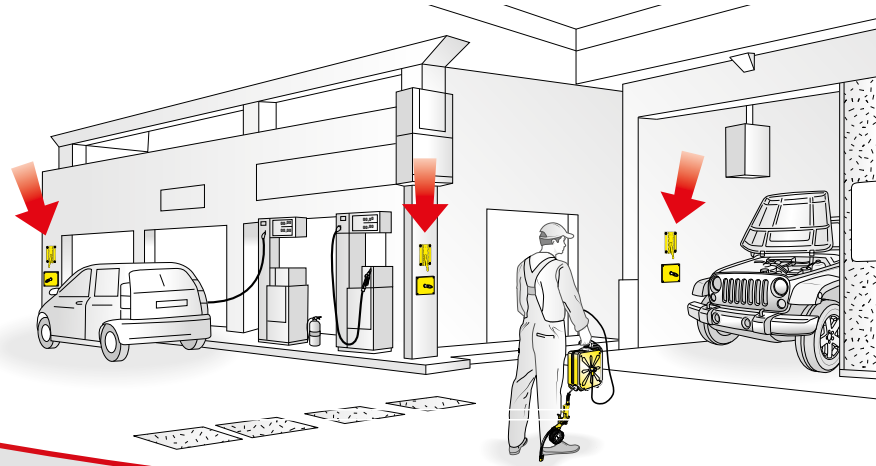

P/N 89005

Hose guide with 4 opposing rollers

for application on service columns - for hose reels s. 250.



P/N 88630

Modular drip tray. Equipped with hook to secure the gun and removable drip tray. Applied under the hose reel, it is a practical housing for the dispensing gun. Essential for a clean, tidy workplace.



P/N 88650

Protective rack side cover in ABS - for hose reel s. 430.

P/N 88651

Protective rack side cover in ABS - for hose reel s. 530 - 540 - 560.



**ADVANCED FLUID
MANAGEMENT SOLUTIONS**

MANUAL HOSE REELS



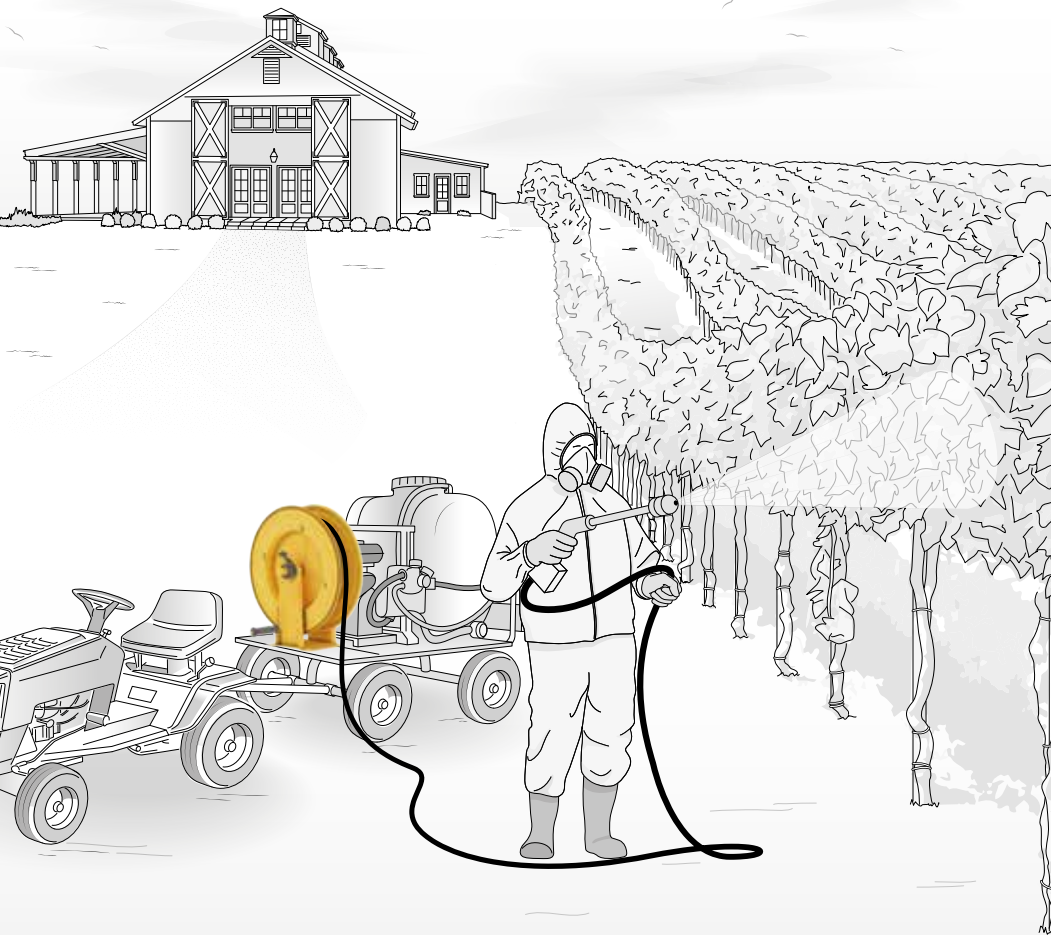

PESTICIDE TREATMENTS IN AGRICULTURE

PNEUMATIC DEMOLITION IN BUILDING

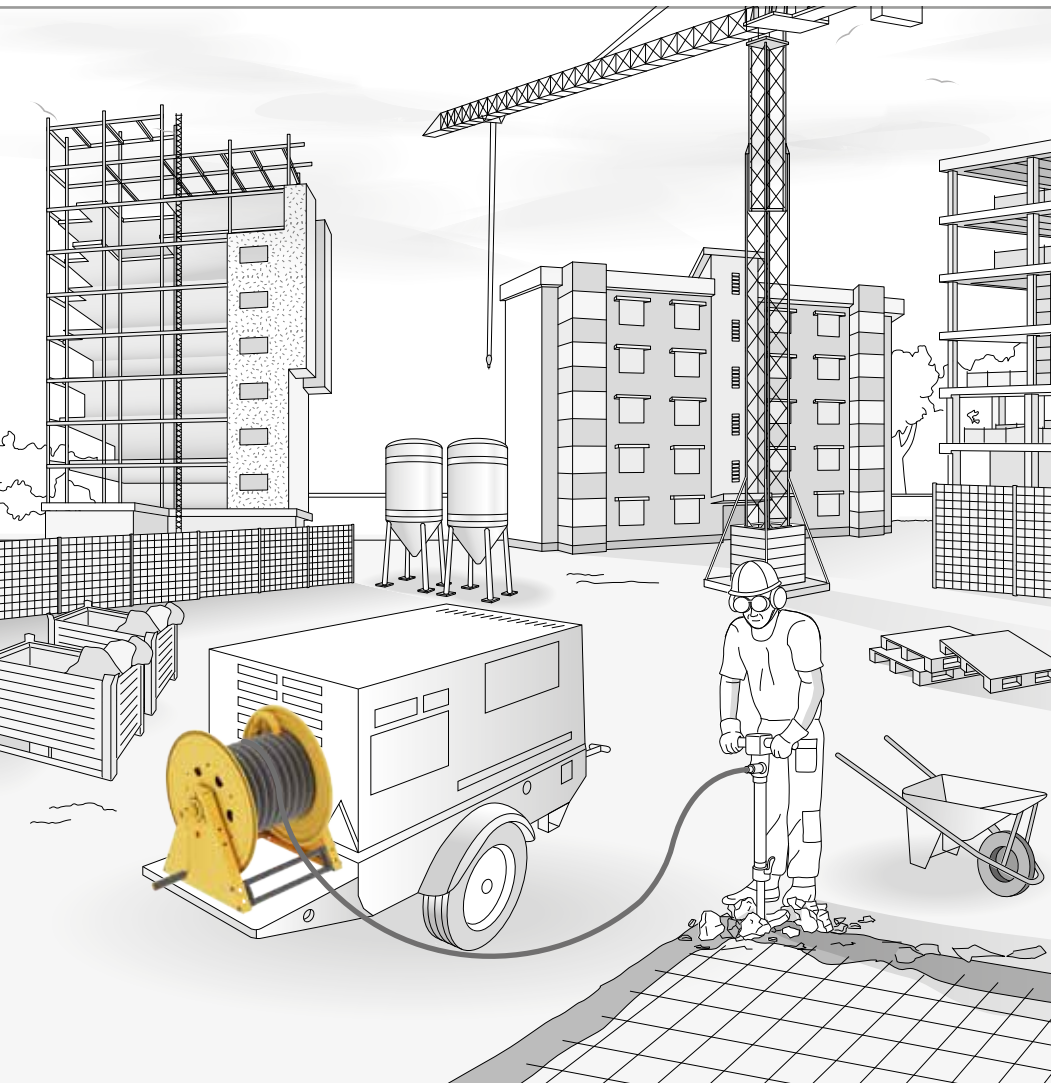

EXAMPLES OF **USE**

CLEANING

AGRICULTURE

SHIPPING AND
OFFSHORE

AERONAUTICS

BUILDING
AND ROAD
CONSTRUCTION

...and much more



**ADVANCED FLUID
MANAGEMENT SOLUTIONS**

MANUAL

HOSE REELS SERIES 430-530 540-560



STRENGTH POINTS

- Standard safety system which prevents the handle from being turned during unwinding, prevents accidental injury or property damage.
- Available in AISI 304 or AISI 316 stainless steel for particularly aggressive environments.
- Optimised winding capacity. The absence of springs maximises use of drum space.
- Available for standard models: adjustable clutch that lets you regulate the speed of drum rotation when unwinding the hose. If necessary, it also serves as brake.
- The optional rotation lock is recommended for use in vibration-prone environments (trucks, industrial machines, etc.).

TECHNICAL CHARACTERISTICS

Visit our
website



DRUM SUPPORT BUSHING

Made of self-lubricating technopolymer with excellent wear and corrosion resistance.

ADJUSTABLE CLUTCH

SAFETY SYSTEM

CENTRAL PIN

Designed to minimise load losses. Available in different materials to ensure maximum chemical compatibility with a wide range of fluids.

ROTATION LOCK

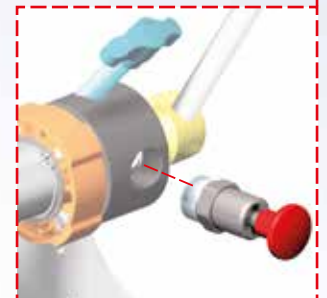

SWIVEL JOINT

Designed to minimise load losses. Available in different materials to ensure maximum chemical compatibility with a wide range of fluids.

FIXING BRACKET

Has 4 slotted holes for safe, easy installation.



**ADVANCED FLUID
MANAGEMENT SOLUTIONS**

MANUAL

HOSE REELS SERIES 500



STRENGTH POINTS

- Standard safety system which prevents the handle from being turned during unwinding, prevents accidental injury or property damage.
- Optimised winding capacity. The absence of a spring and double 1/2" and 1" connections available in the catalogue maximises use of drum space.
- Available for standard models: rotation lock for use in vibration-prone environments (trucks, industrial machines, etc.).
- Available for standard models: adjustable clutch that lets you regulate the speed of drum rotation when unwinding the hose.
- Sturdy structure, epoxy powder-painted - minimum thickness: 80 µm.
- Hose guide with rollers, horizontal and vertical, on 4 sides, designed to extend average hose life, comes standard on all models.

TECHNICAL CHARACTERISTICS

Visit our
website



SWIVEL JOINT

Designed to minimise load losses. Available in different materials to ensure maximum chemical compatibility with a wide range of fluids.

BRAKE DISC

In stainless steel.

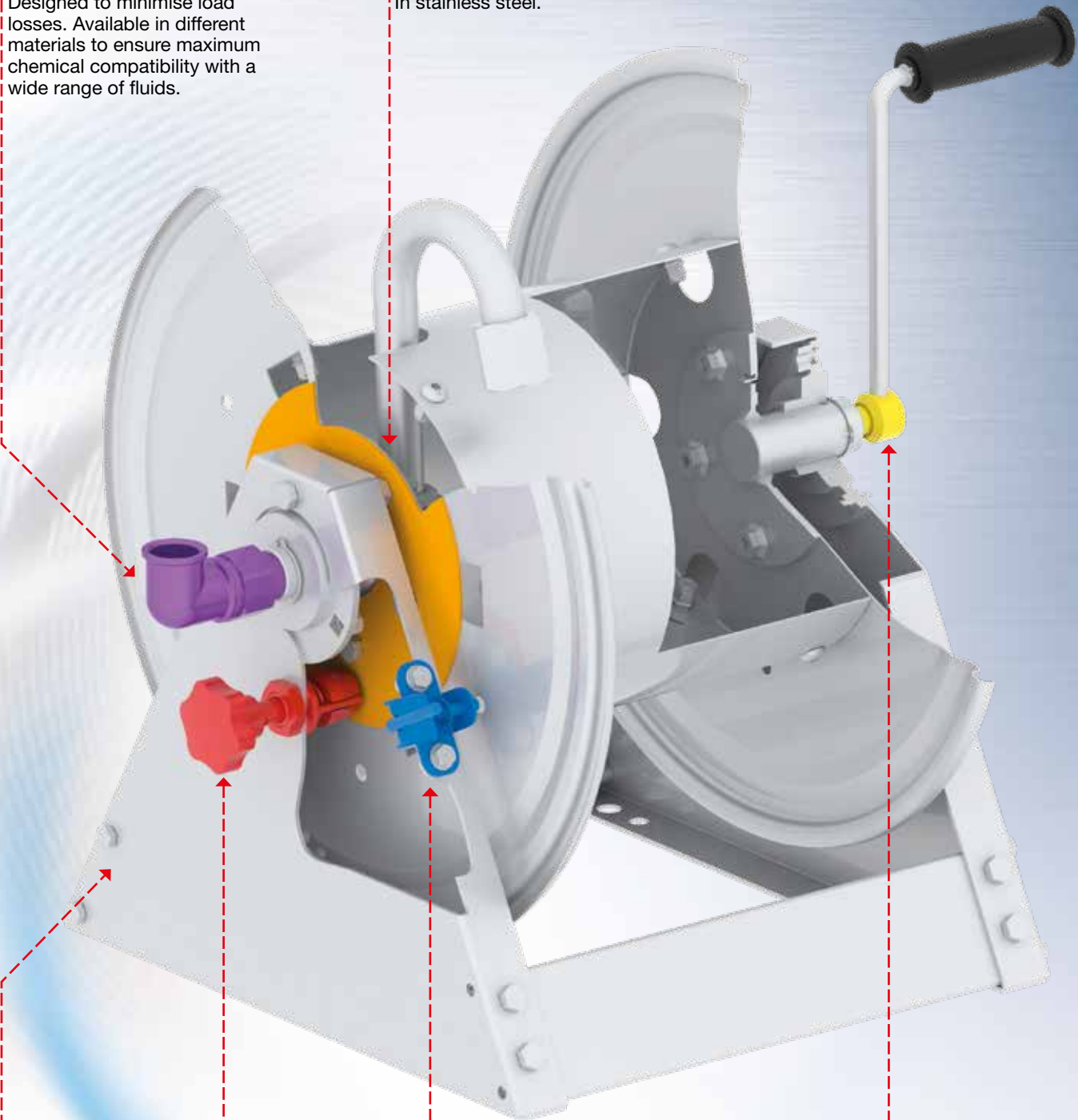

HOSE
GUIDE

ADJUSTABLE
CLUTCH

ROTATION
LOCK

SAFETY
SYSTEM



**ADVANCED FLUID
MANAGEMENT SOLUTIONS**

MANUAL

HOSE REELS SERIES 700

STRENGTH POINTS

- These hose reels are designed so that the rewind handle can be positioned on the opposite side, with the possibility to optimize the workplace.
- During unwinding, a convenient housing has been added where you can safely stow the handle.
- Available for standard models: rotation lock for use in vibration-prone environments (trucks, industrial machines, etc.).
- All moving parts are secured and protected against accidental access from the outside.
- These are the only manual hose reels able to rewind hoses of up to 2" in diameter.
- Hose guide with rollers, horizontal and vertical, on 4 sides, designed to extend average hose life, available on all models.

TECHNICAL CHARACTERISTICS

Visit our
website



SWIVEL JOINT

Designed to minimise load losses.
Available in different materials to ensure
maximum chemical compatibility with a
wide range of fluids.

STANDARD POSITION

ALTERNATIVE POSITION

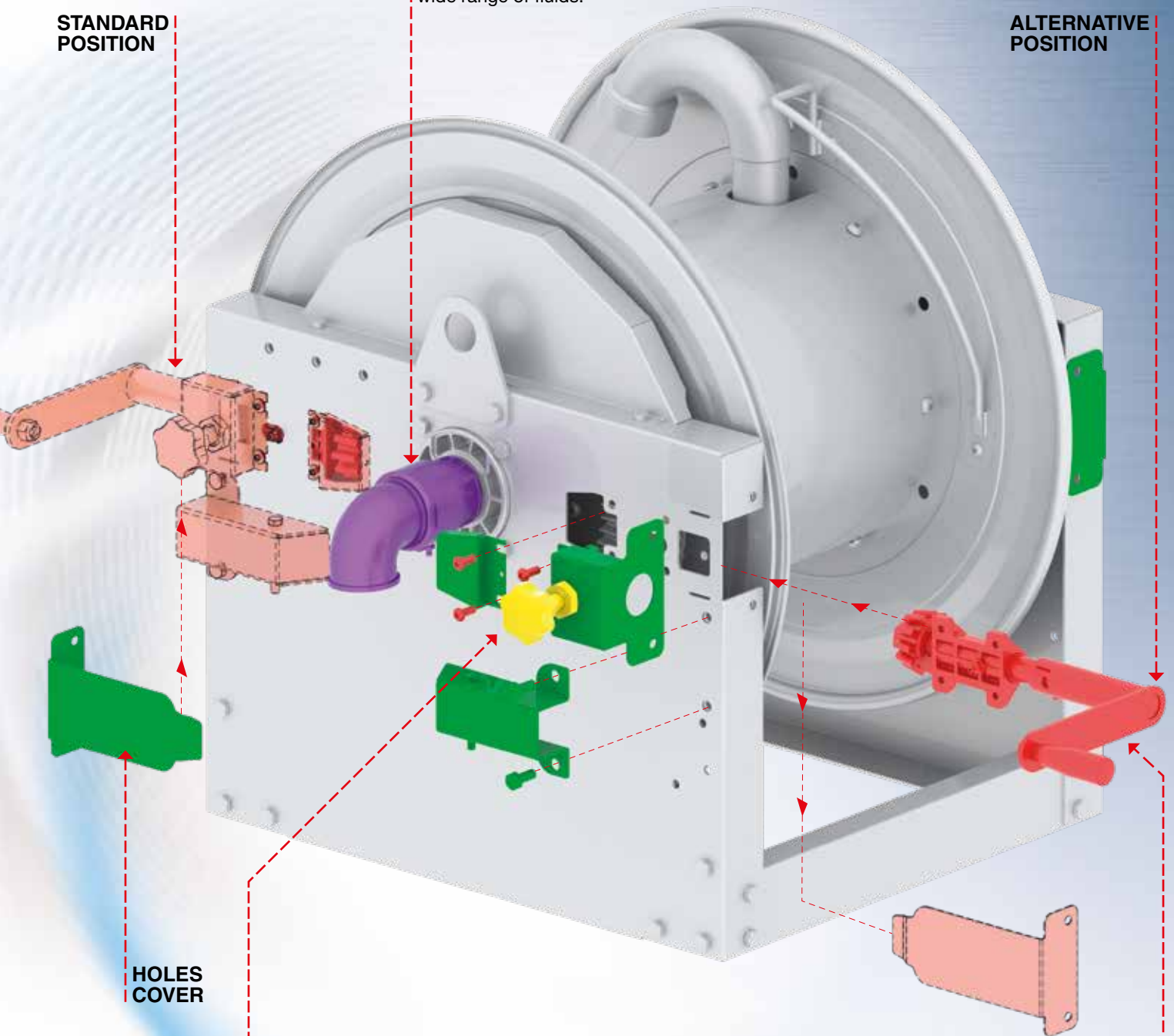

HOLES COVER

ADJUSTABLE CLUTCH

Made of POM, lets you regulate the speed
of drum rotation when unwinding the hose.

HANDLE

Lets you easily
wind up the hose
while controlling
its positioning
on the drum.

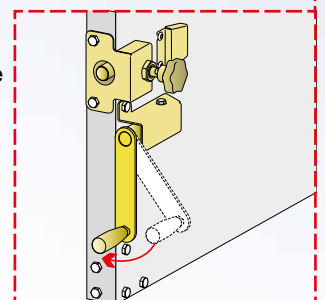

HANDLE MOVEMENT WITH CLUTCH

If required by use of the hose reel, the handle and clutch can be moved from the **standard position** to an **alternative position** with a simple operation indicated in the instruction manual.



Type of fluid
AIR-WATER

Pressure
20 bar

Material
**- PAINTED STEEL
- ABS**

MANUAL

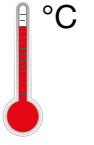

without hose, max. 100 °C



In accordance with directive



for S. 700 version

Seals	Swivel joint	Central pin
Viton®	brass aluminium (s. 700)	galvanized steel

DRUM COLOURS



Overall dimensions (mm)		Series	A	B	C	D	E	F	G	H	I	Packaging (mm) W x D x H	
		430	186	140	197	226	410	97	456	415	264		540 x 390 x 580
		430 ABS	186	140	197	226	405	110	461	425	259		540 x 390 x 580
		530	203	153	220	258	425	104	558	510	315		660 x 390 x 690
		540	300	218	228	268	532	165	572	510	315		640 x 470 x 695
		560	488	399	238	272	712	348	578	510	315		670 x 610 x 760

Overall dimensions s. 500 (mm)		Drum W	A	B	C	D	E	F	G	H	I	L	Packaging (mm) W x D x H	
		240	655	297	313	373	342	220	510	555	468	267		650 x 560 x 700
		320	715	377	313	373	422	300	510	555	468	267		710 x 650 x 700
		460	855	517	313	373	562	440	510	555	468	267		850 x 650 x 700
		600	995	657	313	373	702	580	510	555	468	267		990 x 650 x 700

Overall dimensions s. 700 (mm)		Drum W	A	B	C	D	E	F	G	H	I	L	Packaging (mm) W x D x H	
		270	542	200	300	570	422	260	700	760	659	365		580 x 280 x 590
		410	542	340	440	710	562	398	700	760	659	365		580 x 280 x 590
		550	542	480	580	850	702	538	700	760	659	365		650 x 290 x 700
		690	542	620	720	990	842	680	700	760	659	365		660 x 390 x 690
														(W: width - D: depth - H: height)



	P/N	Drum external width (mm)	Connection						Weight
			inlet			outlet			
s. 430	74300.100	115	G 1/2" (f)			G 1/2" (f)			14,5 kg
	74300.150	115	G 1" (f)			G 3/4" (f)			15,5 kg
Hose reel capacity		inner hose ø	1/4"	5/16"	3/8"	1/2"	5/8"	3/4"	
		max. length	50 m	35 m	25 m	17 m	15 m	8 m	
s. 430 ABS	74305.100	120	G 1/2" (f)			G 1/2" (f)			12,0 kg
	Hose reel capacity		inner hose ø	1/4"	5/16"	3/8"	1/2"	5/8"	
		max. length	50 m	35 m	25 m	17 m	15 m		
s. 530	75300.100	125	G 1/2" (f)			G 1/2" (f)			16,0 kg
	75300.150	125	G 1" (f)			G 1" (f)			17,0 kg
Hose reel capacity		inner hose ø	1/4"	5/16"	3/8"	1/2"	5/8"	3/4"	1"
		max. length	90 m	65 m	35 m	25 m	20 m	15 m	7 m
s. 540	75400.100	190	G 1" (f)			G 1" (f)			18,3 kg
	75400.105	190	G 1/2" (f)			G 1/2" (f)			17,3 kg
Hose reel capacity		inner hose ø	1/4"	5/16"	3/8"	1/2"	5/8"	3/4"	1"
		max. length	150 m	110 m	65 m	45 m	35 m	25 m	15 m
s. 560	75600.100	368	G 1" (f)			G 1" (f)			36,0 kg
	75600.106	368	G 1/2" (f)			G 1/2" (f)			35,0 kg
Hose reel capacity		inner hose ø	1/4"	5/16"	3/8"	1/2"	5/8"	3/4"	1"
		max. length	320 m	240 m	140 m	100 m	90 m	60 m	30 m
s. 500	7522001.100	240	G 1" (f)			G 1" (f)			30,0 kg
	7522001.150	240	G 1/2" (f)			G 1/2" (f)			29,0 kg
	7532001.100	320	G 1" (f)			G 1" (f)			32,5 kg
	7532001.150	320	G 1/2" (f)			G 1/2" (f)			31,5 kg
	7552001.100	460	G 1" (f)			G 1" (f)			36,5 kg
	7552001.150	460	G 1/2" (f)			G 1/2" (f)			35,5 kg
	7562001.100	600	G 1" (f)			G 1" (f)			40,0 kg
	7562001.150	600	G 1/2" (f)			G 1/2" (f)			39,0 kg
Hose reel capacity		inner hose ø	1/4"	3/8"	1/2"	3/4"	1"		
		drum width 240	130 m	85 m	65 m	30 m	20 m		
		drum width 320	200 m	130 m	100 m	50 m	30 m		
		drum width 460	300 m	200 m	150 m	80 m	50 m		
		drum width 600	400 m	280 m	220 m	110 m	70 m		
s. 700 *	7721001.100	270	G 2" (f)			G 2" (f)			88,1 kg
	7741001.100	410	G 2" (f)			G 2" (f)			94,6 kg
	7751001.100	550	G 2" (f)			G 2" (f)			103,0 kg
	7771001.100	690	G 2" (f)			G 2" (f)			119,0 kg
Hose reel capacity		inner hose ø	3/8"	1/2"	3/4"	1"	1.1/4"	1.1/2"	2"
		drum width 270	160 m	110 m	65 m	30 m	20 m	15 m	10 m
		drum width 410	290 m	180 m	120 m	60 m	35 m	30 m	20 m
		drum width 550	420 m	280 m	180 m	100 m	60 m	50 m	30 m
		drum width 690	550 m	350 m	244 m	134 m	84 m	75 m	43 m

* Versions also available with passages and swivel joints in AISI 304-316 stainless steel



Type of fluid
AIR-WATER

Pressure
20 bar

Material
**- AISI 304 S. STEEL
- ABS**

MANUAL

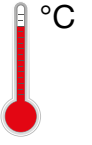

without hose, max. 100 °C



DRUM COLOURS

ABS

Seals	Swivel joint	Central pin
Viton®	brass	AISI 304 s. steel
		

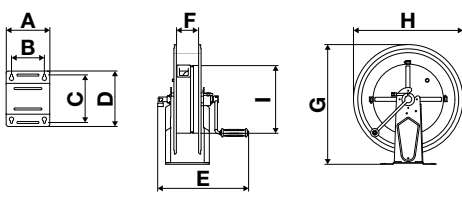
Overall dimensions (mm)	Series	A	B	C	D	E	F	G	H	I	Packaging (mm) W x D x H
		430	186	140	197	226	410	97	456	415	
	430 ABS	186	140	197	226	405	110	461	425	259	540 x 390 x 580
	530	203	153	222	258	425	104	558	510	315	660 x 390 x 690
	540	300	218	228	268	532	165	572	510	315	640 x 470 x 695
	560	488	399	238	272	712	348	578	510	315	670 x 610 x 760

(W: width - D: depth - H: height)



	P/N	Drum external width (mm)	Connection		Weight
			inlet	outlet	
s. 430	74320.100	115	G 1/2" (f)		14,5 kg
	74320.150	115	G 1" (f)		15,5 kg

Hose reel capacity	inner hose Ø	1/4"	5/16"	3/8"	1/2"	5/8"	3/4"
	max. length	50 m	35 m	25 m	17 m	15 m	8 m



s. 430 ABS	74325.100	120	G 1/2" (f)		G 1/2" (f)	12,0 kg
---------------	------------------	-----	------------	--	------------	---------

Hose reel capacity	inner hose Ø	1/4"	5/16"	3/8"	1/2"	5/8"
	max. length	50 m	35 m	25 m	17 m	15 m



s. 530	75320.100	125	G 1/2" (f)		G 1/2" (f)	16,0 kg
	75320.150	125	G 1" (f)		G 1" (f)	17,0 kg

Hose reel capacity	inner hose Ø	1/4"	5/16"	3/8"	1/2"	5/8"	3/4"	1"
	max. length	90 m	65 m	35 m	25 m	20 m	15 m	7 m



s. 540	75420.100	190	G 1" (f)		G 1" (f)	18,5 kg
	75420.105	190	G 1/2" (f)		G 1/2" (f)	17,3 kg

Hose reel capacity	inner hose Ø	1/4"	5/16"	3/8"	1/2"	5/8"	3/4"	1"
	max. length	150 m	110 m	65 m	45 m	35 m	25 m	15 m



s. 560	75620.100	368	G 1" (f)		G 1" (f)	36,0 kg
	75620.106	368	G 1/2" (f)		G 1/2" (f)	35,0 kg

Hose reel capacity	inner hose Ø	1/4"	5/16"	3/8"	1/2"	5/8"	3/4"	1"
	max. length	320 m	240 m	140 m	100 m	90 m	60 m	30 m



Type of fluid
HOT WATER

Pressure
**100-200
400 bar**

Material
**- PAINTED STEEL
- ABS**

MANUAL

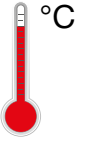

without hose, max. 130 °C



DRUM COLOURS

Painted				
ABS				
S. 500				

Seals	Swivel joint	Central pin
Viton®	AISI 304 s. steel	galvanized steel

Overall dimensions (mm)	Series	A	B	C	D	E	F	G	H	I	Packaging (mm) W x D x H
		430	186	140	197	226	410	97	456	415	
	430 ABS	186	140	197	226	405	110	461	425	259	540 x 390 x 580
	530	203	153	220	258	425	104	558	510	315	660 x 390 x 690
	540	300	218	228	268	532	165	572	510	315	640 x 470 x 695
	560	488	399	238	272	712	348	578	510	315	670 x 610 x 760

(W: width - D: depth - H: height)

Overall dimensions s. 500 (mm)	Drum W	A	B	C	D	E	F	G	H	I	L	Packaging (mm) W x D x H
		240	655	297	313	373	342	220	510	555	468	
	320	715	377	313	373	422	300	510	555	468	267	710 x 650 x 700
	460	855	517	313	373	562	440	510	555	468	267	850 x 650 x 700
	600	995	657	313	373	702	580	510	555	468	267	990 x 650 x 700

(W: width - D: depth - H: height)



	P/N	Drum external width (mm)	Connection					Weight
			inlet		outlet			
s. 430 100 bar	74300.200	115	G 1/2" (f)		G 1/2" (f)			14,5 kg
	74300.250	115	G 1" (f)		G 3/4" (f)			15,5 kg
s. 430 200 bar	74300.300	115	G 3/8" (f)		G 1/2" (f)			14,5 kg
s. 430 400 bar	74300.350	115	G 3/8" (f)		G 1/2" (f)			14,5 kg
Hose reel capacity		inner hose Ø	1/4"	5/16"	3/8"	1/2"	5/8"	3/4"
		max. length	50 m	35 m	25 m	17 m	15 m	8 m
s. 430 ABS 100 bar	74305.200	120	G 1/2" (f)		G 1/2" (f)			12,0 kg
s. 430 ABS 200 bar	74305.300	120	G 3/8" (f)		G 1/2" (f)			12,0 kg
s. 430 ABS 400 bar	74305.350	120	G 3/8" (f)		G 1/2" (f)			12,0 kg
Hose reel capacity		inner hose Ø	1/4"	5/16"	3/8"	1/2"		
		max. length	50 m	35 m	25 m	17 m		
s. 530 100 bar	75300.200	125	G 1/2" (f)		G 1/2" (f)			16,0 kg
s. 530 200 bar	75300.300	125	G 3/8" (f)		G 1/2" (f)			16,0 kg
s. 530 400 bar	75300.350	125	G 3/8" (f)		G 1/2" (f)			16,0 kg
Hose reel capacity		inner hose Ø	1/4"	5/16"	3/8"	1/2"	5/8"	
		max. length	90 m	65 m	35 m	25 m	20 m	
s. 540 100 bar	75400.200	190	G 1" (f)		G 1" (f)			18,3 kg
	75400.205	190	G 1/2" (f)		G 1/2" (f)			17,3 kg
s. 540 200 bar	75400.300	190	G 3/8" (f)		G 1/2" (f)			17,3 kg
s. 540 400 bar	75400.350	190	G 3/8" (f)		G 1/2" (f)			17,3 kg
Hose reel capacity		inner hose Ø	1/4"	5/16"	3/8"	1/2"	5/8"	3/4"
		max. length	150 m	110 m	65 m	45 m	35 m	25 m
s. 560 100 bar	75600.200	368	G 1" (f)		G 1" (f)			36,0 kg
	75600.206	368	G 1/2" (f)		G 1/2" (f)			35,0 kg
s. 560 200 bar	75600.300	368	G 3/8" (f)		G 1/2" (f)			35,0 kg
s. 560 400 bar	75600.350	368	G 3/8" (f)		G 1/2" (f)			35,0 kg
Hose reel capacity		inner hose Ø	1/4"	5/16"	3/8"	1/2"	5/8"	3/4"
		max. length	320 m	240 m	140 m	100 m	90 m	60 m
s. 500 100 bar	7522001.200	240	G 1" (f)		G 1" (f)			30,0 kg
	7522001.250	240	G 1/2" (f)		G 1/2" (f)			29,0 kg
	7532001.200	320	G 1" (f)		G 1" (f)			32,5 kg
	7532001.250	320	G 1/2" (f)		G 1/2" (f)			31,5 kg
	7552001.200	460	G 1" (f)		G 1" (f)			36,5 kg
	7552001.250	460	G 1/2" (f)		G 1/2" (f)			35,5 kg
	7562001.200	600	G 1" (f)		G 1" (f)			40,0 kg
	7562001.250	600	G 1/2" (f)		G 1/2" (f)			39,0 kg
s. 500 200 bar	7522001.300	240	G 3/8" (f)		G 1/2" (f)			29,0 kg
	7532001.300	320	G 3/8" (f)		G 1/2" (f)			31,5 kg
	7552001.300	460	G 3/8" (f)		G 1/2" (f)			35,5 kg
	7562001.300	600	G 3/8" (f)		G 1/2" (f)			39,0 kg
Hose reel capacity		inner hose Ø	1/4"	3/8"	1/2"	3/4"	1"	
		drum width 240	130 m	85 m	65 m	30 m	20 m	
		drum width 320	200 m	130 m	100 m	50 m	30 m	
		drum width 460	300 m	200 m	150 m	80 m	50 m	
		drum width 600	400 m	280 m	220 m	110 m	70 m	



Type of fluid
HOT WATER

Pressure
**70-100
200-400 bar**

Material
**- AISI 304 S. STEEL
- AISI 316 S. STEEL
- ABS**

MANUAL

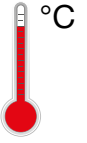

without hose, max. 130 °C



In accordance with directive



for S. 700 version

Seals	Swivel joint	Central pin
Viton®	AISI 304-316 s. steel	AISI 304-316 s. steel
		

DRUM COLOURS

ABS 

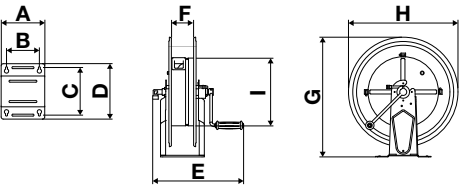
Overall dimensions (mm)	Series	A	B	C	D	E	F	G	H	I	Packaging (mm) W x D x H
		430	186	140	197	226	410	97	456	415	
	430 ABS	186	140	197	226	405	110	461	425	259	540 x 390 x 580
	530	203	153	220	258	425	104	558	510	315	660 x 390 x 690
	540	300	218	228	268	532	165	572	510	315	640 x 470 x 695
	560	488	399	238	272	712	348	578	510	315	670 x 610 x 760

(W: width - D: depth - H: height)

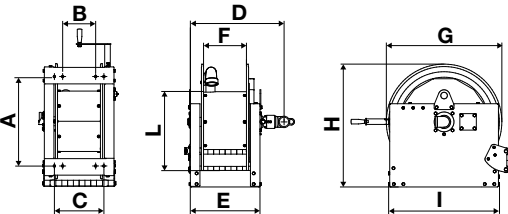
Overall dimensions s. 700 (mm)	Drum W	A	B	C	D	E	F	G	H	I	L	Packaging (mm) W x D x H
	270	542	200	300	570	422	260	700	760	659	365	
	410	542	340	440	710	562	398	700	760	659	365	580 x 280 x 590
	550	542	480	580	850	702	538	700	760	659	365	650 x 290 x 700
	690	542	620	720	990	842	680	700	760	659	365	660 x 390 x 690

(W: width - D: depth - H: height)

	P/N AISI 304 stainless steel	P/N AISI 316 stainless steel	Drum width (mm)	Connection		Weight
				inlet	outlet	



s. 430 100 bar	74340.200	74350.200	115	G 1/2" (f)	G 1/2" (f)	14,5 kg
	74340.250	-	115	G 1" (f)	G 3/4" (f)	15,5 kg
s. 430 200 bar	74340.300	74350.300	115	G 3/8" (f)	G 1/2" (f)	14,5 kg
s. 430 400 bar	74340.350	74350.350	115	G 3/8" (f)	G 1/2" (f)	14,5 kg

Hose reel capacity	inner hose ø	1/4"	5/16"	3/8"	1/2"	5/8"	3/4"
	max. length	50 m	35 m	25 m	17 m	15 m	8 m



s. 430 ABS 100 bar	74345.200	-	120	G 1/2" (f)	G 1/2" (f)	12,0 kg
s. 430 ABS 200 bar	74345.300	-	120	G 3/8" (f)	G 1/2" (f)	12,0 kg
s. 430 ABS 400 bar	74345.350	-	120	G 3/8" (f)	G 1/2" (f)	12,0 kg

Hose reel capacity	inner hose ø	1/4"	5/16"	3/8"	1/2"
	max. length	50 m	35 m	25 m	17 m



s. 530 100 bar	75340.200	75350.200	115	G 1/2" (f)	G 1/2" (f)	16,0 kg
s. 530 200 bar	75340.300	75350.300	115	G 3/8" (f)	G 1/2" (f)	16,0 kg
s. 530 400 bar	75340.350	75350.350	115	G 3/8" (f)	G 1/2" (f)	16,0 kg

Hose reel capacity	inner hose ø	1/4"	5/16"	3/8"	1/2"	5/8"
	max. length	90 m	65 m	35 m	25 m	20 m



s. 540 100 bar	75440.200	75450.200	190	G 1" (f)	G 1" (f)	18,3 kg
	75440.205	75450.205	190	G 1/2" (f)	G 1/2" (f)	17,3 kg
s. 540 200 bar	75440.300	-	190	G 3/8" (f)	G 1/2" (f)	17,3 kg
s. 540 400 bar	75440.350	-	190	G 3/8" (f)	G 1/2" (f)	17,3 kg

Hose reel capacity	inner hose ø	1/4"	5/16"	3/8"	1/2"	5/8"	3/4"	1"
	max. length	150 m	110 m	65 m	45 m	35 m	25 m	15 m



s. 560 100 bar	75640.200	75650.200	368	G 1" (f)	G 1" (f)	35,0 kg
	75640.206	75650.206	368	G 1/2" (f)	G 1/2" (f)	35,0 kg
s. 560 200 bar	75640.300	-	368	G 3/8" (f)	G 1/2" (f)	35,0 kg
s. 560 400 bar	75640.350	-	368	G 3/8" (f)	G 1/2" (f)	35,0 kg

Hose reel capacity	inner hose ø	1/4"	5/16"	3/8"	1/2"	5/8"	3/4"	1"
	max. length	320 m	240 m	140 m	100 m	90 m	60 m	30 m



s. 700 70 bar	7724001.200	7725001.200	270	G 2" (f)	G 2" (f)	88,1 kg
	7744001.200	7745001.200	410	G 2" (f)	G 2" (f)	94,6 kg
	7754001.200	7755001.200	550	G 2" (f)	G 2" (f)	103,0 kg
	7774001.200	7775001.200	690	G 2" (f)	G 2" (f)	119,0 kg

Hose reel capacity	inner hose ø	3/8"	1/2"	3/4"	1"	1.1/4"	1.1/2"	2"
	drum width 270	160 m	110 m	65 m	30 m	20 m	15 m	10 m
	drum width 410	290 m	180 m	120 m	60 m	35 m	30 m	20 m
	drum width 550	420 m	280 m	180 m	100 m	60 m	50 m	30 m
	drum width 690	550 m	350 m	244 m	134 m	84 m	75 m	43 m



Type of fluid
**OIL AND
SIMILAR**

Pressure
70-150 bar

Material
**- PAINTED STEEL
- ABS**

MANUAL

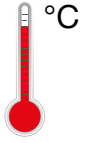
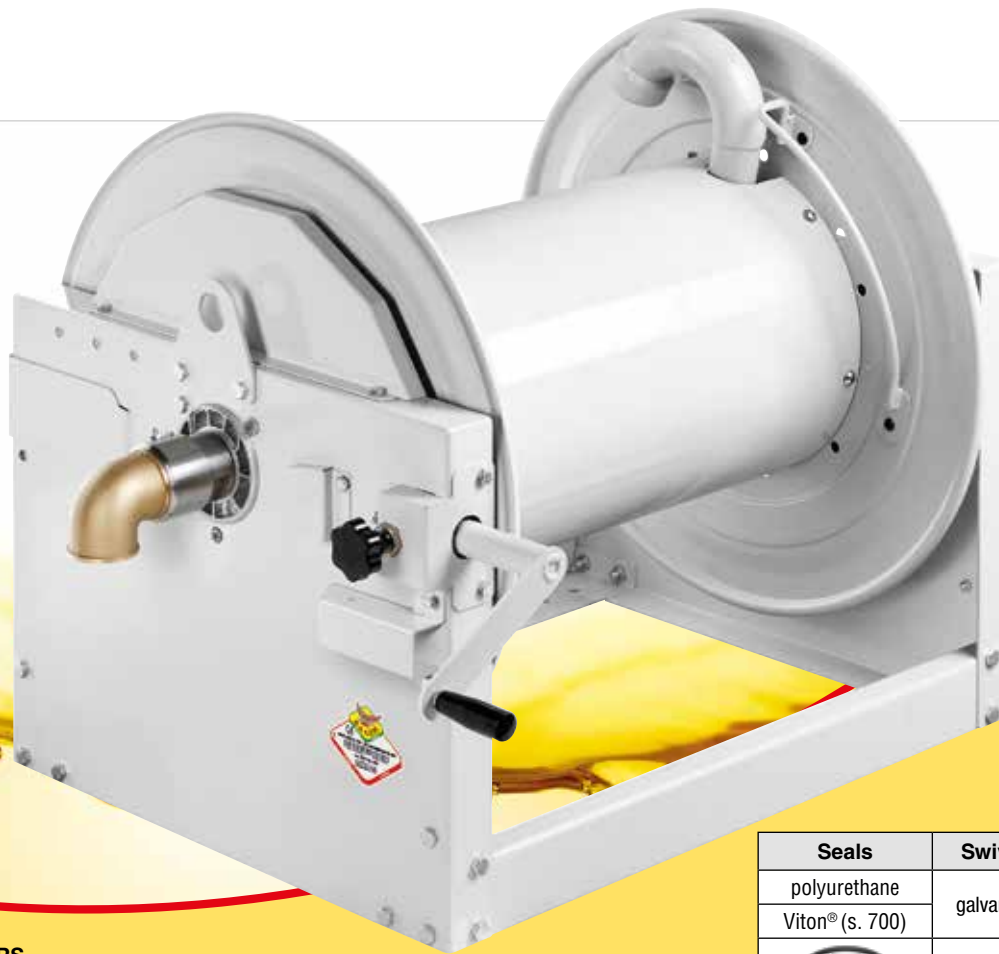

without hose, max. 80 °C

In accordance with directive



for S. 700 version

Seals	Swivel joint	Central pin
polyurethane Viton® (s. 700)	galvanized steel	galvanized steel

DRUM COLOURS

Painted					S. 500 - 700	
ABS						

Overall dimensions (mm)		Series	A	B	C	D	E	F	G	H	I	Packaging (mm) W x D x H
		430	186	140	197	226	410	97	456	415	264	540 x 390 x 580
		430 ABS	186	140	197	226	405	110	461	425	259	540 x 390 x 580
		530	203	153	220	258	425	104	558	510	315	660 x 390 x 690
		540	300	218	228	268	532	165	572	510	315	640 x 470 x 695
		560	488	399	238	272	712	348	578	510	315	670 x 610 x 760

(W: width - D: depth - H: height)

Overall dimensions s. 500 (mm)		Drum W	A	B	C	D	E	F	G	H	I	L	Packaging (mm) W x D x H
		240	655	297	313	373	342	220	510	555	468	267	650 x 560 x 700
		320	715	377	313	373	422	300	510	555	468	267	710 x 650 x 700
		460	855	517	313	373	562	440	510	555	468	267	850 x 650 x 700
		600	995	657	313	373	702	580	510	555	468	267	990 x 650 x 700

(W: width - D: depth - H: height)

Overall dimensions s. 700 (mm)		Drum W	A	B	C	D	E	F	G	H	I	Packaging (mm) W x D x H	
		270	542	200	300	570	422	260	700	760	659	365	820 x 770 x 845
		410	542	340	440	710	562	398	700	760	659	365	875 x 845 x 820
		550	542	480	580	850	702	538	700	760	659	365	1030 x 830 x 830
		690	542	620	720	990	842	680	700	760	659	365	1170 x 830 x 845

(W: width - D: depth - H: height)



P/N	Drum external width (mm)	Connection						Weight
		inlet			outlet			

s. 430 150 bar	74300.400	115	G 1/2" (f)			G 1/2" (f)		14,5 kg
	74300.450	115	G 1" (f)			G 3/4" (f)		14,5 kg

Hose reel capacity	inner hose ø	1/4"	5/16"	3/8"	1/2"	5/8"	3/4"
	max. length	50 m	35 m	25 m	17 m	15 m	8 m

s. 430 ABS 150 bar	74305.400	120	G 1/2" (f)			G 1/2" (f)		12,0 kg
------------------------------	------------------	-----	------------	--	--	------------	--	---------

Hose reel capacity	inner hose ø	1/4"	5/16"	3/8"	1/2"
	max. length	50 m	35 m	25 m	17 m

s. 530 150 bar	75300.400	125	G 1/2" (f)			G 1/2" (f)		16,0 kg
--------------------------	------------------	-----	------------	--	--	------------	--	---------

Hose reel capacity	inner hose ø	1/4"	5/16"	3/8"	1/2"	5/8"
	max. length	90 m	65 m	35 m	25 m	20 m

s. 540 150 bar	75400.400	190	G 1" (f)			G 1" (f)		18,3 kg
	75400.405	190	G 1/2" (f)			G 1/2" (f)		17,3 kg

Hose reel capacity	inner hose ø	1/4"	5/16"	3/8"	1/2"	5/8"	3/4"	1"
	max. length	150 m	110 m	65 m	45 m	35 m	25 m	15 m

s. 560 150 bar	75600.400	368	G 1" (f)			G 1" (f)		36,0 kg
	75600.406	368	G 1/2" (f)			G 1/2" (f)		35,0 kg

Hose reel capacity	inner hose ø	1/4"	5/16"	3/8"	1/2"	5/8"	3/4"	1"
	max. length	320 m	240 m	140 m	85 m	90 m	60 m	30 m

s. 500 150 bar	7522001.400	240	G 1" (f)			G 1" (f)		30,0 kg
	7522001.450	240	G 1/2" (f)			G 1/2" (f)		29,0 kg
	7532001.400	320	G 1" (f)			G 1" (f)		32,5 kg
	7532001.450	320	G 1/2" (f)			G 1/2" (f)		31,5 kg
	7552001.400	460	G 1" (f)			G 1" (f)		36,5 kg
	7552001.450	460	G 1/2" (f)			G 1/2" (f)		35,5 kg
	7562001.400	600	G 1" (f)			G 1" (f)		40,0 kg
	7562001.450	600	G 1/2" (f)			G 1/2" (f)		39,0 kg

Hose reel capacity	inner hose ø	1/4"	3/8"	1/2"	3/4"	1"
	drum width 240	130 m	85 m	65 m	30 m	20 m
	drum width 320	200 m	130 m	100 m	50 m	30 m
	drum width 460	300 m	200 m	150 m	80 m	50 m
	drum width 600	400 m	280 m	220 m	110 m	70 m

s. 700 70 bar	7721001.400	270	G 2" (f)			G 2" (f)		88,1 kg
	7741001.400	410	G 2" (f)			G 2" (f)		94,6 kg
	7751001.400	550	G 2" (f)			G 2" (f)		103,0 kg
	7771001.400	690	G 2" (f)			G 2" (f)		119,0 kg

Hose reel capacity	inner hose ø	3/8"	1/2"	3/4"	1"	1.1/4"	1.1/2"	2"
	drum width 270	160 m	110 m	65 m	30 m	20 m	15 m	10 m
	drum width 410	290 m	180 m	120 m	60 m	35 m	30 m	20 m
	drum width 550	420 m	280 m	180 m	100 m	60 m	50 m	30 m
	drum width 690	550 m	350 m	244 m	134 m	84 m	75 m	43 m



Type of fluid
**OIL AND
SIMILAR**

Pressure
150 bar

Material
**- AISI 304 S. STEEL
- ABS**

MANUAL

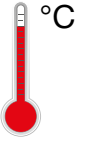



without hose, max. 130 °C



DRUM COLOURS

ABS

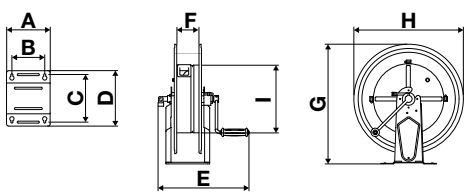
Seals	Swivel joint	Central pin
Viton®	AISI 304 s. steel	AISI 304 s. steel
		

Overall dimensions (mm)			Series	A	B	C	D	E	F	G	H	I	Packaging (mm) W x D x H
			430	186	140	197	226	410	97	456	415	264	 540 x 390 x 580 540 x 390 x 580 660 x 390 x 690 640 x 470 x 695 670 x 610 x 760
			430 ABS	186	140	197	226	405	110	461	425	259	
			530	203	153	220	258	425	104	558	510	315	
			540	300	218	228	268	532	165	572	510	315	
			560	488	399	238	272	712	348	578	510	315	

(W: width - D: depth - H: height)



P/N	Drum external width (mm)	Connection		Weight	
		inlet	outlet		
s. 430	74340.200	115	G 1/2" (f)	G 1/2" (f)	14,5 kg

Hose reel capacity	inner hose ø	1/4"	5/16"	3/8"	1/2"
	max. length	50 m	35 m	25 m	17 m



s. 430 ABS	74345.200	120	G 1/2" (f)	G 1/2" (f)	12,0 kg
-------------------	------------------	-----	------------	------------	---------

Hose reel capacity	inner hose ø	1/4"	5/16"	3/8"	1/2"
	max. length	50 m	35 m	25 m	17 m



s. 530	75340.200	125	G 1/2" (f)	G 1/2" (f)	16,0 kg
---------------	------------------	-----	------------	------------	---------

Hose reel capacity	inner hose ø	1/4"	5/16"	3/8"	1/2"	5/8"
	max. length	90 m	65 m	35 m	25 m	20 m



s. 540	75440.200	190	G 1" (f)	G 1" (f)	18,3 kg
	75440.205	190	G 1/2" (f)	G 1/2" (f)	17,3 kg

Hose reel capacity	inner hose ø	1/4"	5/16"	3/8"	1/2"	5/8"	3/4"	1"
	max. length	150 m	110 m	65 m	45 m	35 m	25 m	15 m



s. 560	75640.200	368	G 1" (f)	G 1" (f)	36,0 kg
	75640.206	368	G 1/2" (f)	G 1/2" (f)	35,0 kg

Hose reel capacity	inner hose ø	1/4"	5/16"	3/8"	1/2"	5/8"	3/4"	1"
	max. length	320 m	240 m	140 m	85 m	90 m	60 m	30 m



Type of fluid
GREASE

Pressure
600 bar

Material
**- PAINTED STEEL
- ABS**

MANUAL

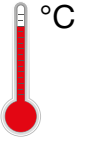

without hose, max. 80 °C



DRUM COLOURS

Painted 
ABS 

Seals	Swivel joint	Central pin
polyurethane	galvanized steel	galvanized steel
		

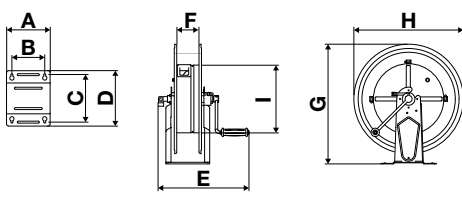
Overall dimensions (mm)	Series	A	B	C	D	E	F	G	H	I	Packaging (mm) W x D x H
		430	186	140	197	226	410	97	456	415	
	430 ABS	186	140	197	226	405	110	461	425	259	540 x 390 x 580
	530	203	153	220	258	425	104	558	510	315	660 x 390 x 690
	540	300	218	228	268	532	165	572	510	315	640 x 470 x 695
	560	488	399	238	272	712	348	578	510	315	670 x 610 x 760

(W: width - D: depth - H: height)



	P/N	Drum external width (mm)	Connection				Weight	
			inlet		outlet			
s. 430	74300.500	115	G 3/8" (f)		G 1/2" (f)		14,5 kg	
Hose reel capacity			inner hose ø	1/4"	5/16"	3/8"	1/2"	5/8"
			max. length	50 m	35 m	25 m	17 m	15 m
s. 430 ABS	74305.500	120	G 3/8" (f)		G 1/2" (f)		12,0 kg	
Hose reel capacity			inner hose ø	1/4"	5/16"	3/8"	1/2"	5/8"
			max. length	50 m	35 m	25 m	17 m	15 m
s. 530	75300.500	125	G 3/8" (f)		G 1/2" (f)		16,0 kg	
Hose reel capacity			inner hose ø	1/4"	5/16"	3/8"	1/2"	5/8"
			max. length	90 m	65 m	35 m	25 m	20 m
s. 540	75400.500	190	G 3/8" (f)		G 1/2" (f)		17,3 kg	
Hose reel capacity			inner hose ø	1/4"	5/16"	3/8"	1/2"	5/8"
			max. length	150 m	110 m	65 m	45 m	35 m
s. 560	75600.500	368	G 3/8" (f)		G 1/2" (f)		35,0 kg	
Hose reel capacity			inner hose ø	1/4"	5/16"	3/8"	1/2"	5/8"
			max. length	320 m	240 m	140 m	100 m	90 m



Type of fluid
GREASE

Pressure
600 bar

Material
- AISI 304 S. STEEL
- ABS

MANUAL

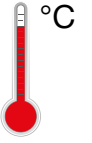

without hose, max. 80 °C



Seals	Swivel joint	Central pin
polyurethane	galvanized steel	AISI 304 s. steel
		

DRUM COLOURS

ABS     

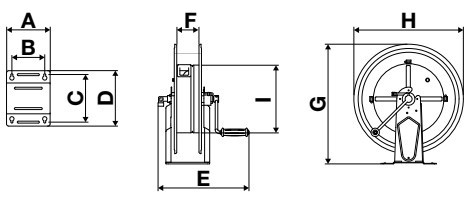
Overall dimensions (mm)	Series	A	B	C	D	E	F	G	H	I	Packaging (mm) W x D x H
		430	186	140	197	226	410	97	456	415	
	430 ABS	186	140	197	226	405	110	461	425	259	540 x 390 x 580
	530	203	153	220	258	425	104	558	510	315	660 x 390 x 690
	540	300	218	228	268	532	165	572	510	315	640 x 470 x 695
	560	488	399	238	272	712	348	578	510	315	670 x 610 x 760

(W: width - D: depth - H: height)



P/N	Drum external width (mm)	Connection		Weight	
		inlet	outlet		
s. 430	74320.500	115	G 3/8" (f)	G 1/2" (f)	14,5 kg

Hose reel capacity	inner hose ø	1/4"	5/16"	3/8"	1/2"	5/8"
	max. length	50 m	35 m	25 m	17 m	15 m



s. 430 ABS	74325.500	120	G 3/8" (f)	G 1/2" (f)	12,0 kg
-----------------------	------------------	-----	------------	------------	---------

Hose reel capacity	inner hose ø	1/4"	5/16"	3/8"	1/2"	5/8"
	max. length	50 m	35 m	25 m	17 m	15 m



s. 530	75320.500	125	G 3/8" (f)	G 1/2" (f)	16,0 kg
---------------	------------------	-----	------------	------------	---------

Hose reel capacity	inner hose ø	1/4"	5/16"	3/8"	1/2"	5/8"
	max. length	90 m	65 m	35 m	25 m	20 m



s. 540	75420.500	190	G 3/8" (f)	G 1/2" (f)	17,3 kg
---------------	------------------	-----	------------	------------	---------

Hose reel capacity	inner hose ø	1/4"	5/16"	3/8"	1/2"	5/8"
	max. length	150 m	110 m	65 m	45 m	35 m



s. 560	75620.500	368	G 3/8" (f)	G 1/2" (f)	35,0 kg
---------------	------------------	-----	------------	------------	---------

Hose reel capacity	inner hose ø	1/4"	5/16"	3/8"	1/2"	5/8"
	max. length	320 m	240 m	140 m	100 m	90 m



Type of fluid
DIESEL

Pressure
20 bar

Material
**- PAINTED STEEL
- ABS**

MANUAL

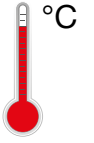

without hose, max. 100 °C

In accordance with directive





for S. 700 version

Seals	Swivel joint	Central pin
	brass	galvanized steel
	aluminum (s. 700)	
		

DRUM COLOURS

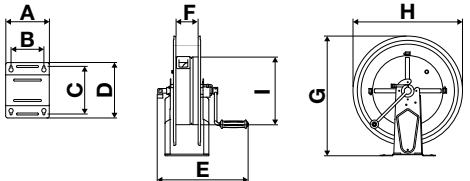
Painted					S. 500 - 700	
ABS						

Overall dimensions (mm)			Series	A	B	C	D	E	F	G	H	I	Packaging (mm) W x D x H	
			430	186	140	197	226	410	97	456	415	264		540 x 390 x 580
			430 ABS	186	140	197	226	405	110	461	425	259		540 x 390 x 580
			530	203	153	220	258	425	104	558	510	315		660 x 390 x 690
			540	300	218	228	268	532	165	572	510	315		640 x 470 x 695
			560	488	399	238	272	712	348	578	510	315		670 x 610 x 760

(W: width - D: depth - H: height)

Overall dimensions s. 500 (mm)			Drum W	A	B	C	D	E	F	G	H	I	L	Packaging (mm) W x D x H	
			240	655	297	313	373	342	220	510	555	468	267		650 x 560 x 700
			320	715	377	313	373	422	300	510	555	468	267		710 x 650 x 700
			460	855	517	313	373	562	440	510	555	468	267		850 x 650 x 700
			600	995	657	313	373	702	580	510	555	468	267		990 x 650 x 700

(W: width - D: depth - H: height)

Overall dimensions s. 700 (mm)			Drum W	A	B	C	D	E	F	G	H	I	L	Packaging (mm) W x D x H	
			270	542	200	300	570	422	260	700	760	659	365		820 x 770 x 845
			410	542	340	440	710	562	398	700	760	659	365		875 x 845 x 820
			550	542	480	580	850	702	538	700	760	659	365		1030 x 830 x 830
			690	542	620	720	990	842	680	700	760	659	365		1170 x 830 x 845

(W: width - D: depth - H: height)



	P/N	Drum external width (mm)	Connection						Weight
			inlet			outlet			
s. 430	74300.600	115	G 1/2" (f)			G 1/2" (m)			14,5 kg
Hose reel capacity		inner hose ø	1/4"	5/16"	3/8"	1/2"	5/8"	3/4"	
		max. length	50 m	35 m	25 m	17 m	15 m	8 m	
s. 430 ABS	74305.600	120	G 1/2" (f)			G 1/2" (m)			12,0 kg
Hose reel capacity		inner hose ø	1/4"	5/16"	3/8"	1/2"	5/8"	3/4"	
		max. length	50 m	35 m	25 m	17 m	15 m	8 m	
s. 530	75300.150	125	G 1" (f)			G 1" (f)			16,0 kg
Hose reel capacity		inner hose ø	1/4"	5/16"	3/8"	1/2"	5/8"	3/4"	1"
		max. length	90 m	65 m	35 m	25 m	20 m	15 m	7 m
s. 540	75400.100	190	G 1" (f)			G 1" (f)			18,3 kg
Hose reel capacity		inner hose ø	1/4"	5/16"	3/8"	1/2"	5/8"	3/4"	1"
		max. length	150 m	110 m	65 m	45 m	35 m	25 m	15 m
s. 560	75600.100	368	G 1" (f)			G 1" (f)			36,0 kg
Hose reel capacity		inner hose ø	1/4"	5/16"	3/8"	1/2"	5/8"	3/4"	1"
		max. length	320 m	240 m	140 m	100 m	90 m	60 m	30 m
s. 500	7522001.100	240	G 1" (f)			G 1" (f)			30,0 kg
	7532001.100	320	G 1" (f)			G 1" (f)			32,5 kg
	7552001.100	460	G 1" (f)			G 1" (f)			36,5 kg
	7562001.100	600	G 1" (f)			G 1" (f)			40,0 kg
Hose reel capacity		inner hose ø	1/4"	3/8"	1/2"	3/4"	1"		
		drum width 240	130 m	85 m	65 m	30 m	20 m		
		drum width 320	200 m	130 m	100 m	50 m	30 m		
		drum width 460	300 m	200 m	150 m	80 m	50 m		
		drum width 600	400 m	280 m	220 m	110 m	70 m		
s. 700	7721001.100	270	G 2" (f)			G 2" (f)			88,1 kg
	7741001.100	410	G 2" (f)			G 2" (f)			94,6 kg
	7751001.100	550	G 2" (f)			G 2" (f)			103,2 kg
	7771001.100	690	G 2" (f)			G 2" (f)			119,0 kg
Hose reel capacity		inner hose ø	3/8"	1/2"	3/4"	1"	1.1/4"	1.1/2"	2"
		drum width 270	160 m	110 m	65 m	30 m	20 m	15 m	10 m
		drum width 410	290 m	180 m	120 m	60 m	35 m	30 m	20 m
		drum width 550	420 m	280 m	180 m	100 m	60 m	50 m	30 m
		drum width 690	550 m	350 m	244 m	134 m	84 m	75 m	43 m

Prepared with outlet connection for ø 3/4" hoses



Type of fluid
DIESEL

Pressure
20 bar

Material
**- AISI 304 S. STEEL
- ABS**

MANUAL

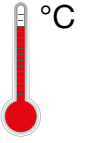

without hose, max. 100 °C



DRUM COLOURS

ABS

Seals	Swivel joint	Central pin
Viton®	brass	AISI 304 s. steel
		

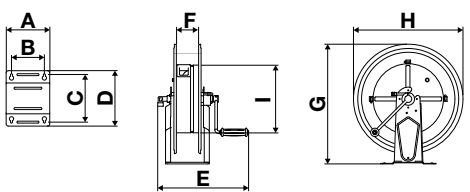
Overall dimensions (mm)		Series	A	B	C	D	E	F	G	H	I	Packaging (mm) W x D x H
		430	186	140	197	226	410	97	456	415	264	540 x 390 x 580
		430 ABS	186	140	197	226	405	110	461	425	259	540 x 390 x 580
		530	203	153	220	258	425	104	558	510	315	660 x 390 x 690
		540	300	218	228	268	532	165	572	510	315	640 x 470 x 695
		560	488	399	238	272	712	348	578	510	315	670 x 610 x 760

(W: width - D: depth - H: height)



P/N	Drum external width (mm)	Connection						Weight	
		inlet			outlet				
s. 430	74320.600	115	G 1/2" (f)			G 1/2" (m)			14,5 kg

Hose reel capacity	inner hose ø	1/4"	5/16"	3/8"	1/2"	5/8"	3/4"
	max. length	50 m	35 m	25 m	17 m	15 m	8 m



s. 430 ABS	74325.600	120	G 1/2" (f)			G 1/2" (m)			12,0 kg
-----------------------	------------------	-----	------------	--	--	------------	--	--	---------

Hose reel capacity	inner hose ø	1/4"	5/16"	3/8"	1/2"	5/8"	3/4"
	max. length	50 m	35 m	25 m	17 m	15 m	8 m



s. 530	75320.150	125	G 1" (f)			G 1" (f)			16,0 kg
---------------	------------------	-----	----------	--	--	----------	--	--	---------

Hose reel capacity	inner hose ø	1/4"	5/16"	3/8"	1/2"	5/8"	3/4"	1"
	max. length	90 m	65 m	35 m	25 m	20 m	15 m	7 m



s. 540	75420.100	190	G 1" (f)			G 1" (f)			18,3 kg
---------------	------------------	-----	----------	--	--	----------	--	--	---------

Hose reel capacity	inner hose ø	1/4"	5/16"	3/8"	1/2"	5/8"	3/4"	1"
	max. length	150 m	110 m	65 m	45 m	35 m	25 m	15 m



s. 560	75620.100	368	G 1" (f)			G 1" (f)			36,0 kg
---------------	------------------	-----	----------	--	--	----------	--	--	---------

Hose reel capacity	inner hose ø	1/4"	5/16"	3/8"	1/2"	5/8"	3/4"	1"
	max. length	320 m	240 m	140 m	100 m	90 m	60 m	30 m

 Prepared with outlet connection for ø 3/4" hoses



**ADVANCED FLUID
MANAGEMENT SOLUTIONS**

MANUAL TROLLEY-MOUNTED HOSE REELS



EXAMPLES OF USE

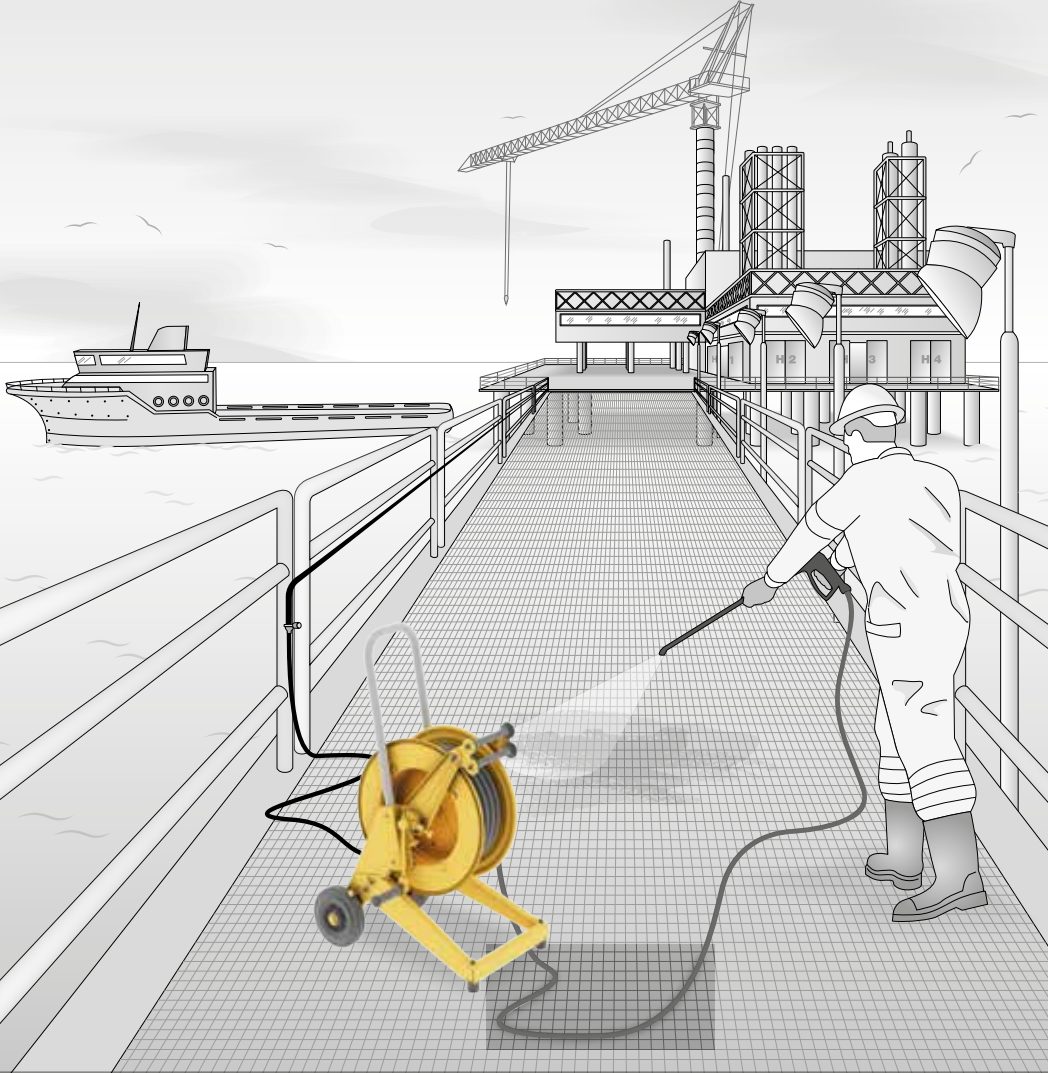

OFFSHORE FACILITIES CLEANING

HEALTHY AND FOOD ENVIRONMENTS WASHING OPERATIONS

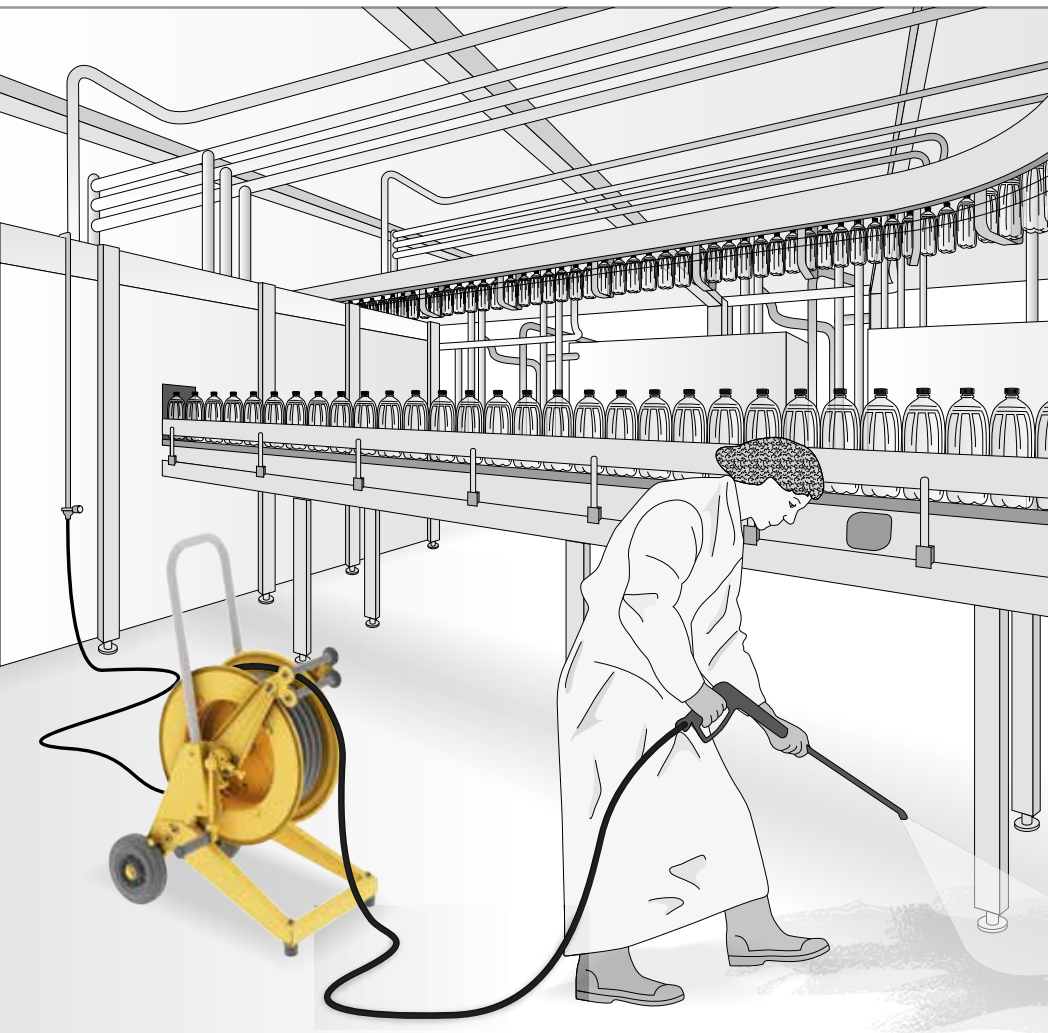

MINING
INDUSTRY

AGRICULTURE

SHIPPING AND
OFFSHORE

MANUFACTUR-
ING INDUSTRY

AERONAUTICS

...and much more



**ADVANCED FLUID
MANAGEMENT SOLUTIONS**

MANUAL

TROLLEY-MOUNTED HOSE REELS

STRENGTH POINTS

- The trolley has been designed to meet specific parameters and prevent rollover during hose unwinding, achieved with the special brake and geometry of the floor stands.
- Super block trolley brake comes standard on all models, automatically locks the trolley only when stationary.
- Standard safety system which prevents the handle from being turned during unwinding, prevents accidental injury or property damage.
- Fold-in handle as standard reduces the overall dimensions of the hose reel and simultaneously increases safety.
- Standard hose guide to extend average hose life and facilitate unwinding.
- Adjustable clutch and rotation lock are standard, let you modulate rotation speed or completely lock the drum.

TECHNICAL CHARACTERISTICS

Visit our
website

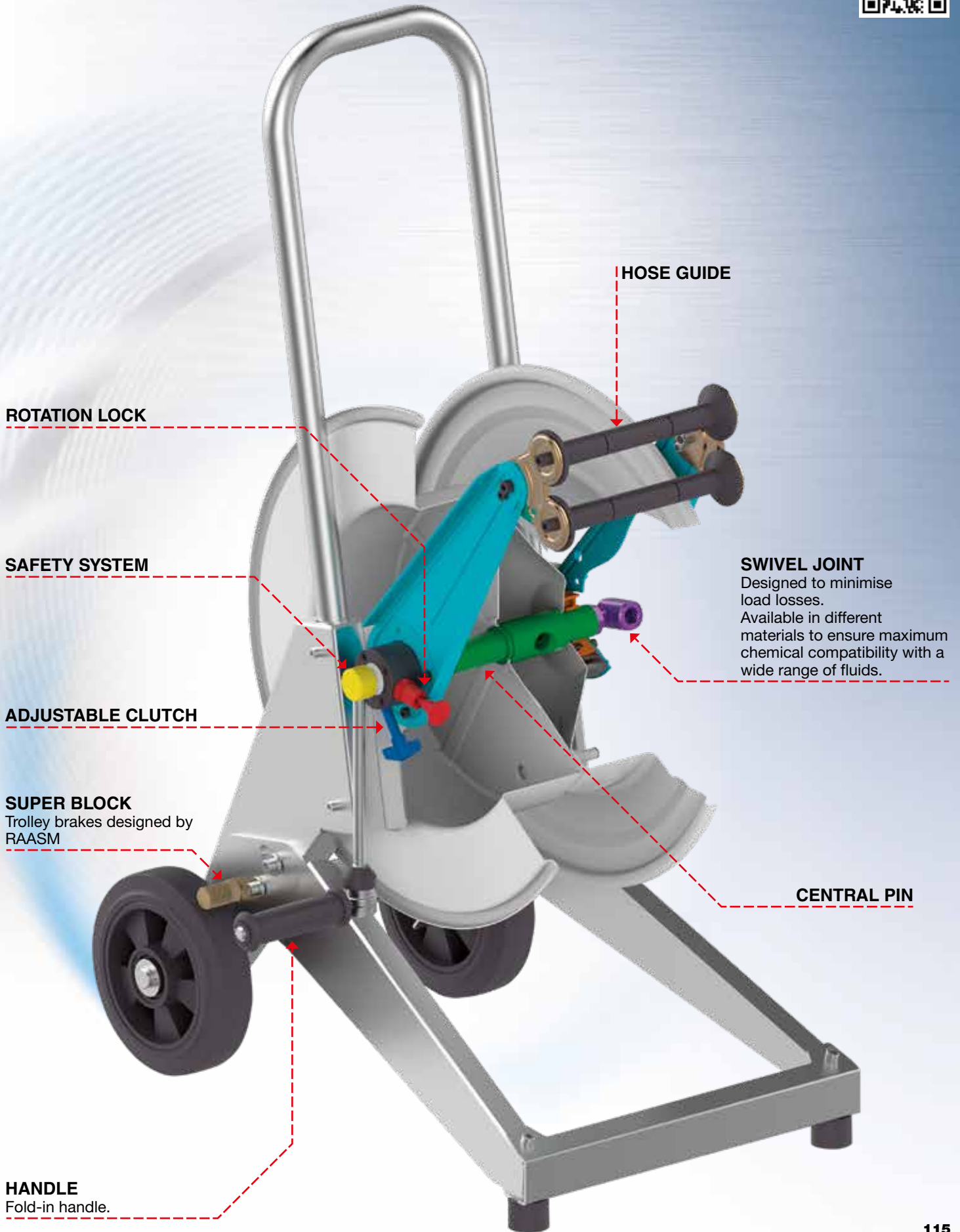

ROTATION LOCK

SAFETY SYSTEM

ADJUSTABLE CLUTCH

SUPER BLOCK
Trolley brakes designed by
RAASM

HANDLE
Fold-in handle.

HOSE GUIDE

SWIVEL JOINT
Designed to minimise
load losses.
Available in different
materials to ensure maximum
chemical compatibility with a
wide range of fluids.

CENTRAL PIN



Hose reel
**TROLLEY-
MOUNTED**



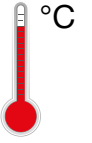

Pressure
**20-100
200-400 bar**

Material
PAINTED STEEL

MANUAL





- without hose:
with brass swivel joint
max. 100 °C
with steel swivel joint
max. 130 °C

	Trolley	Drum	Seals	Swivel joint	Central pin
AIR-WATER	galvanized steel	painted steel	Viton®	brass	galvanized steel
HOT WATER	galvanized steel	painted steel	Viton® - Teflon®	AISI 304 s. steel	galvanized steel
					

DRUM COLOURS

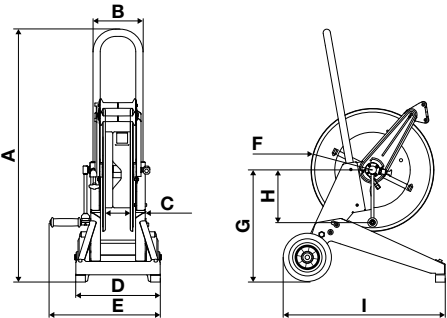
Painted

Overall dimensions (mm)		Series	A	B	C	D	E	F	G	H	I	Packaging (mm) W x D x H
		530	1050	210	104	350	464	510	463	205	675	 650 x 290 x 700
		540	1050	270	165	413	530	510	463	205	675	660 x 390 x 690
		560	1050	450	348	595	705	510	463	205	675	670 x 610 x 760

(W: width - D: depth - H: height)



s. 530



s. 540



s. 560

P/N	Hose supplied	Connection		Weight
		inlet	outlet	

AIR-WATER 20 bar

s. 530	236530.100	without hose *	G 1/2" (f)		G 1/2" (f)		29,0 kg		
* Hose reel capacity		inner hose Ø	1/4"	5/16"	3/8"	1/2"	5/8"	3/4"	1"
		max. length	90 m	65 m	35 m	25 m	20 m	15 m	7 m
s. 540	236540.100	without hose *	G 1" (f)		G 1" (f)		34,0 kg		
	236540.105	without hose *	G 1/2" (f)		G 1/2" (f)		33,0 kg		
* Hose reel capacity		inner hose Ø	1/4"	5/16"	3/8"	1/2"	5/8"	3/4"	1"
		max. length	150 m	110 m	65 m	45 m	35 m	25 m	15 m
s. 560	236560.100	without hose *	G 1" (f)		G 1" (f)		40,0 kg		
	236560.105	without hose *	G 1/2" (f)		G 1/2" (f)		39,0 kg		
* Hose reel capacity		inner hose Ø	1/4"	5/16"	3/8"	1/2"	5/8"	3/4"	1"
		max. length	320 m	240 m	140 m	100 m	90 m	60 m	30 m

HOT WATER 100 bar

s. 530	236530.200	without hose *	G 1/2" (f)		G 1/2" (f)		29,0 kg		
* Hose reel capacity		inner hose Ø	1/4"	5/16"	3/8"	1/2"	5/8"	3/4"	1"
		max. length	90 m	65 m	35 m	25 m	20 m	15 m	7 m
s. 540	236540.200	without hose *	G 1" (f)		G 1" (f)		34,0 kg		
	236540.205	without hose *	G 1/2" (f)		G 1/2" (f)		33,0 kg		
* Hose reel capacity		inner hose Ø	1/4"	5/16"	3/8"	1/2"	5/8"	3/4"	1"
		max. length	150 m	110 m	65 m	45 m	35 m	25 m	15 m
s. 560	236560.200	without hose *	G 1" (f)		G 1" (f)		35,0 kg		
	236560.205	without hose *	G 1/2" (f)		G 1/2" (f)		35,0 kg		
* Hose reel capacity		inner hose Ø	1/4"	5/16"	3/8"	1/2"	5/8"	3/4"	1"
		max. length	320 m	240 m	140 m	100 m	90 m	60 m	30 m

HOT WATER 200 bar

s. 530	236530.300	without hose *	G 3/8" (f)		G 1/2" (f)		29,0 kg
* Hose reel capacity		inner hose Ø	1/4"	5/16"	3/8"	1/2"	
		max. length	90 m	65 m	35 m	25 m	
s. 540	236540.300	without hose *	G 3/8" (f)		G 1/2" (f)		33,0 kg
* Hose reel capacity		inner hose Ø	1/4"	5/16"	3/8"	1/2"	
		max. length	150 m	110 m	65 m	45 m	
s. 560	236560.300	without hose *	G 3/8" (f)		G 1/2" (f)		40,0 kg
* Hose reel capacity		inner hose Ø	1/4"	5/16"	3/8"	1/2"	
		max. length	320 m	240 m	140 m	100 m	

HOT WATER 400 bar

s. 530	236530.350	without hose *	G 3/8" (f)		G 1/2" (f)		29,0 kg
* Hose reel capacity		inner hose Ø	1/4"	5/16"	3/8"		
		max. length	90 m	65 m	35 m		
s. 540	236540.350	without hose *	G 3/8" (f)		G 1/2" (f)		33,0 kg
* Hose reel capacity		inner hose Ø	1/4"	5/16"	3/8"		
		max. length	150 m	110 m	65 m		
s. 560	236560.350	without hose *	G 3/8" (f)		G 1/2" (f)		40,0 kg
* Hose reel capacity		inner hose Ø	1/4"	5/16"	3/8"		
		max. length	320 m	240 m	140 m		



Hose reel
TROLLEY-MOUNTED

Pressure
**20-100
 200-400 bar**

Material
**- AISI 304 S. STEEL
 - AISI 316 S. STEEL**

MANUAL

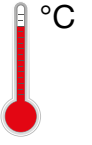

- without hose:
 with brass swivel joint
 max. 100 °C
 with steel swivel joint
 max. 130 °C



	Trolley	Drum	Seals	Swivel joint	Central pin
AIR-WATER	AISI 304-316 stainless steel	AISI 304-316 stainless steel	Viton®	brass	AISI 304-316 stainless steel
HOT WATER			Viton® - Teflon®	AISI 304-316 s. steel	

Overall dimensions (mm)	Series	A	B	C	D	E	F	G	H	I	Packaging (mm) W x D x H
	530	1050	210	104	350	464	510	463	205	675	
	540	1050	270	165	413	530	510	463	205	675	660 x 390 x 690
	560	1050	450	348	595	705	510	463	205	675	670 x 610 x 760

(W: width - D: depth - H: height)

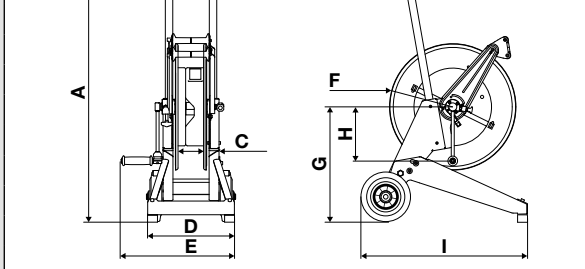



s. 530



s. 540



s. 560

P/N AISI 304 stainless steel	P/N AISI 316 stainless steel	Hose supplied	Connection		Weight
			inlet	outlet	

AIR-WATER 20 bar

s. 530	246532.100	-	without hose *	G 1/2" (f)	G 1/2" (f)	29,0 kg		
* Hose reel capacity	inner hose Ø	1/4"	5/16"	3/8"	1/2"	5/8"	3/4"	1"
	max. length	90 m	65 m	35 m	25 m	20 m	15 m	7 m
s. 540	246542.100	-	without hose *	G 1" (f)	G 1" (f)	34,0 kg		
	246542.105	-	without hose *	G 1/2" (f)	G 1/2" (f)	33,0 kg		
* Hose reel capacity	inner hose Ø	1/4"	5/16"	3/8"	1/2"	5/8"	3/4"	1"
	max. length	150 m	110 m	65 m	45 m	35 m	25 m	15 m
s. 560	246562.100	-	without hose *	G 1" (f)	G 1" (f)	40,0 kg		
	246562.105	-	without hose *	G 1/2" (f)	G 1/2" (f)	39,0 kg		
* Hose reel capacity	inner hose Ø	1/4"	5/16"	3/8"	1/2"	5/8"	3/4"	1"
	max. length	320 m	240 m	140 m	100 m	90 m	60 m	30 m

HOT WATER 100 bar

s. 530	246534.200	256535.200	without hose *	G 1/2" (f)	G 1/2" (f)	29,0 kg		
* Hose reel capacity	inner hose Ø	1/4"	5/16"	3/8"	1/2"	5/8"	3/4"	1"
	max. length	90 m	65 m	35 m	25 m	20 m	15 m	7 m
s. 540	246544.200	256545.200	without hose *	G 1" (f)	G 1" (f)	34,0 kg		
	246544.205	256545.205	without hose *	G 1/2" (f)	G 1/2" (f)	33,0 kg		
* Hose reel capacity	inner hose Ø	1/4"	5/16"	3/8"	1/2"	5/8"	3/4"	1"
	max. length	150 m	110 m	65 m	45 m	35 m	25 m	15 m
s. 560	246564.200	256565.200	without hose *	G 1" (f)	G 1" (f)	40,0 kg		
	246564.205	256565.205	without hose *	G 1/2" (f)	G 1/2" (f)	35,0 kg		
* Hose reel capacity	inner hose Ø	1/4"	5/16"	3/8"	1/2"	5/8"	3/4"	1"
	max. length	320 m	240 m	140 m	100 m	90 m	60 m	30 m

HOT WATER 200 bar

s. 530	246534.300	256535.300	without hose *	G 3/8" (f)	G 1/2" (f)	29,0 kg	
* Hose reel capacity	inner hose Ø	1/4"	5/16"	3/8"	1/2"		
	max. length	90 m	65 m	35 m	25 m		
s. 540	246544.300	256545.300	without hose *	G 3/8" (f)	G 1/2" (f)	33,0 kg	
* Hose reel capacity	inner hose Ø	1/4"	5/16"	3/8"	1/2"		
	max. length	150 m	110 m	65 m	45 m		
s. 560	246564.300	256565.300	without hose *	G 3/8" (f)	G 1/2" (f)	40,0 kg	
* Hose reel capacity	inner hose Ø	1/4"	5/16"	3/8"	1/2"		
	max. length	320 m	240 m	140 m	100 m		

HOT WATER 400 bar

s. 530	246534.350	256535.350	without hose *	G 3/8" (f)	G 1/2" (f)	29,0 kg	
* Hose reel capacity	inner hose Ø	1/4"	5/16"	3/8"			
	max. length	90 m	65 m	35 m			
s. 540	246544.350	256545.350	without hose *	G 3/8" (f)	G 1/2" (f)	33,0 kg	
* Hose reel capacity	inner hose Ø	1/4"	5/16"	3/8"			
	max. length	150 m	110 m	65 m			
s. 560	246564.350	256565.350	without hose *	G 3/8" (f)	G 1/2" (f)	40,0 kg	
* Hose reel capacity	inner hose Ø	1/4"	5/16"	3/8"			
	max. length	320 m	240 m	140 m			



ACCESSORIES FOR MANUAL HOSE REELS



P/N 843001
P/N 853001



P/N 843002
P/N 853002

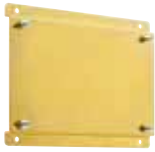

P/N 854001
P/N 856001



P/N 854002
P/N 856002



PAINTED STEEL

STAINLESS STEEL



GALVANIZED STEEL



STAINLESS STEEL



P/N 843001

Fixed support in steel for fixed painted steel hose reels s. 430.

P/N 843002

Fixed support in AISI 304 stainless steel - for fixed hose reels in AISI 304 stainless steel s. 430.

P/N 853001

Fixed support in steel - for fixed painted steel hose reels s. 530.

P/N 853002

Fixed support in AISI 304 stainless steel - for fixed hose reels in AISI 304 stainless steel s. 530.

P/N 854001

Fixed support in steel - for fixed painted steel hose reels s. 540.

P/N 854002

Fixed support in AISI 304 stainless steel - for fixed hose reels in AISI 304 stainless steel s. 540.

P/N 856001

Fixed support in steel - for fixed painted steel hose reels s. 560.

P/N 856002

Fixed support in AISI 304 stainless steel - for fixed hose reels in AISI 304 stainless steel s. 560.

For more information on the supports, see page 80.

ARMS AND HOSE GUIDE
FOR MANUAL HOSE REEL

	painting steel	AISI 304 stainless steel	AISI 316 stainless steel
s. 430	P/N 743001	P/N 743401	P/N 743501
s. 530	P/N 753001	P/N 753401	P/N 753501
s. 540	P/N 754001	P/N 754401	P/N 754501
s. 560	P/N 756001	P/N 756401	P/N 756501

FOLD-IN HANDLE
FOR MANUAL HOSE REEL

	galvanized steel	AISI 304 stainless steel	AISI 316 stainless steel
s. 430	P/N 743004	P/N 743404	P/N 743504
s. 530 s. 540 s. 560	P/N 753004	P/N 753404	P/N 753504

P/N 74301

Rotation lock in AISI 304 stainless steel - for hose reels in painted steel and AISI 304 stainless steel series 430 - 430 ABS - 530 - 540 - 560.

P/N 74302

Rotation lock in AISI 316 stainless steel - for hose reels in painted steel and AISI 316 stainless steel series 430 - 430 ABS - 530 - 540 - 560.

P/N 88650

Protective rack side cover in ABS - for hose reel series 430.

P/N 88651

Protective rack side cover in ABS - for hose reel series 530 - 540 - 560.



ACCESSORIES FOR MANUAL, PAINTED STEEL HOSE REELS SERIES 700



High manual operation hose guide
P/N 77/22775B for width 270 mm
P/N 77/24175B for width 410 mm
P/N 77/25575B for width 550 mm
P/N 77/26975B for width 690 mm

By operating the special handle, the operator moves the hose to the right or left, ensuring correct rewinding.



Low manual operation hose guide
P/N 77/22775 for width 270 mm
P/N 77/24175 for width 410 mm
P/N 77/25575 for width 550 mm
P/N 77/26975 for width 690 mm

Standard closed hose guide, high
P/N 77/12775B for width 270 mm
P/N 77/14175B for width 410 mm
P/N 77/15575B for width 550 mm
P/N 77/16975B for width 690 mm

Hose guide with rollers that allow the hose to slide easily during unwinding and rewinding operations.



Standard closed hose guide, low
P/N 77/12775 for width 270 mm
P/N 77/14175 for width 410 mm
P/N 77/15575 for width 550 mm
P/N 77/16975 for width 690 mm

Standard open hose guide, high
P/N 77/32775B for width 270 mm
P/N 77/34175B for width 410 mm
P/N 77/35575B for width 550 mm
P/N 77/36975B for width 690 mm

This type of hose guide allows for installation of both versions (high and low) on the same hose reel, thus allowing hose unwinding in two opposing directions.

Standard open hose guide, low
P/N 77/32775 for width 270 mm
P/N 77/34175 for width 410 mm
P/N 77/35575 for width 550 mm
P/N 77/36975 for width 690 mm



P/N 77/2F Painted steel free fall clutch permits controlled unwinding of the hose and switches to neutral during rewinding phase.

P/N 77/3F Free fall clutch in AISI 316 stainless steel permits controlled unwinding of the hose and switches to neutral during rewinding phase.

P/N 77/4F Free fall clutch in AISI 304 stainless steel permits controlled unwinding of the hose and switches to neutral during rewinding phase.

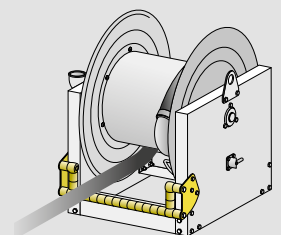
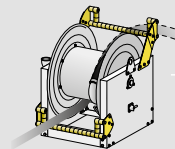
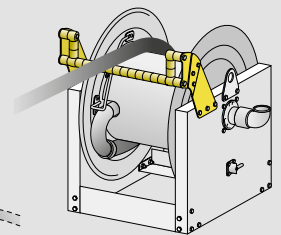
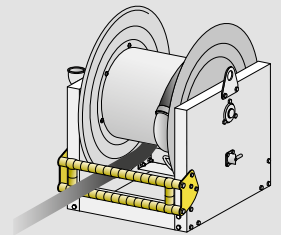
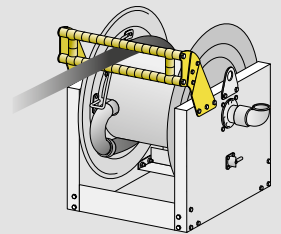
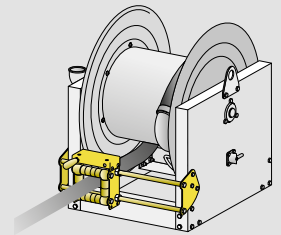
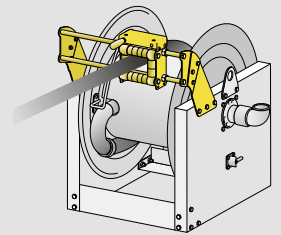



**ADVANCED FLUID
MANAGEMENT SOLUTIONS**

MOTORIZED HOSE REELS



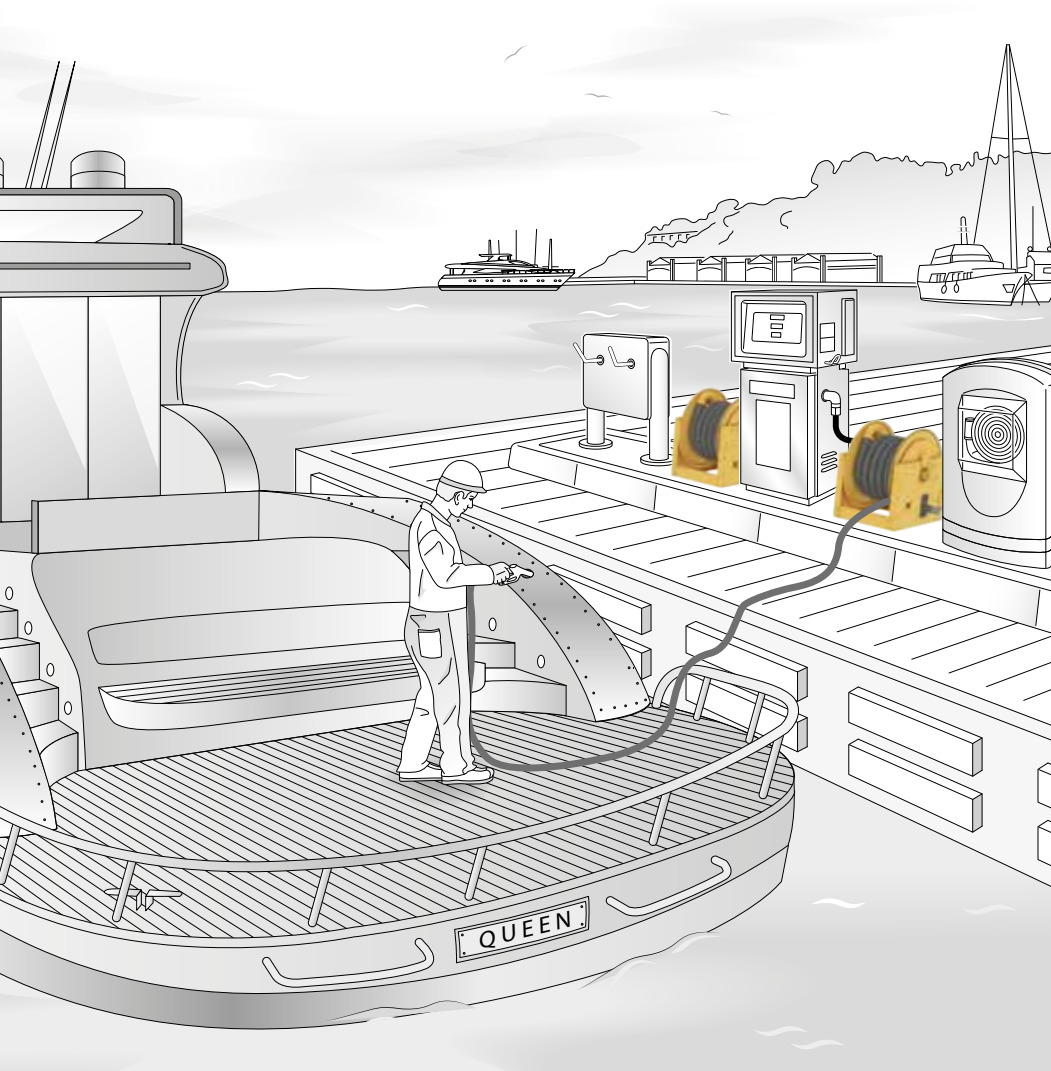

REFUELLING SHIPS IN PORT

ROADS CLEANING

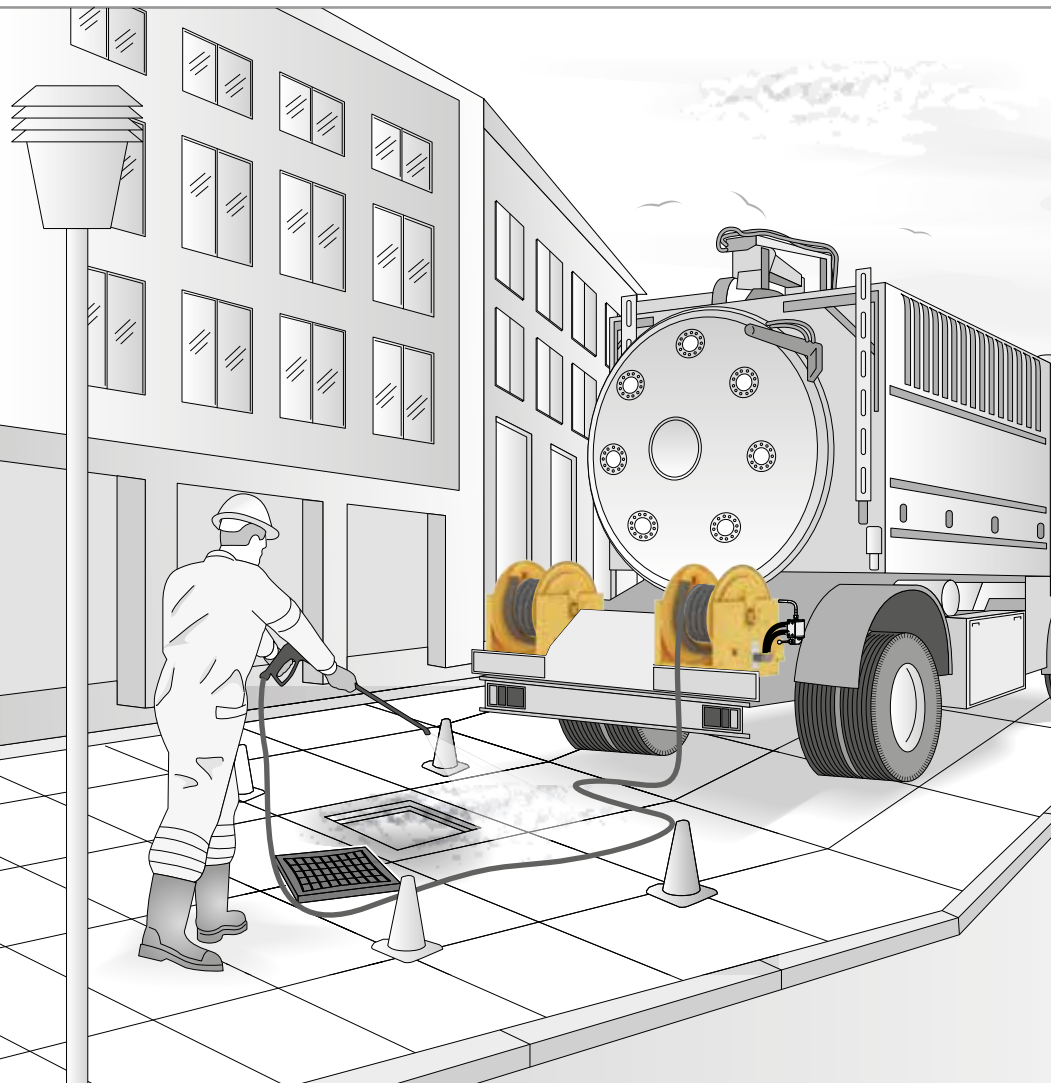

EXAMPLES OF USE

LUBE
TRUCKS AND
INDUSTRIAL
VEHICLES

MINING
INDUSTRY

SHIPPING AND
OFFSHORE

CHEMICAL
INDUSTRY

RAILWAY
TRANSPORT

...and much more



**ADVANCED FLUID
MANAGEMENT SOLUTIONS**

MOTORIZED HOSE REELS

✓ STRENGTH POINTS

- Different hose guides have been designed to extend average hose life and facilitate unwinding.
- Available for all standard models: rotation lock for use in vibration-prone environments (trucks, industrial machines, etc.).
- All moving parts are secured and protected against accidental access from the outside.
- The catalogue also contains models compliant with the ATEX directive for use in environments with potentially explosive atmospheres.
- Articles are also available in AISI 304 and 316 stainless steel for use in aggressive or corrosive environments.
- These are the largest capacity hose reels in the RAASM product range for rewinding hoses up to 2" in diameter.

TECHNICAL CHARACTERISTICS

Visit our
website

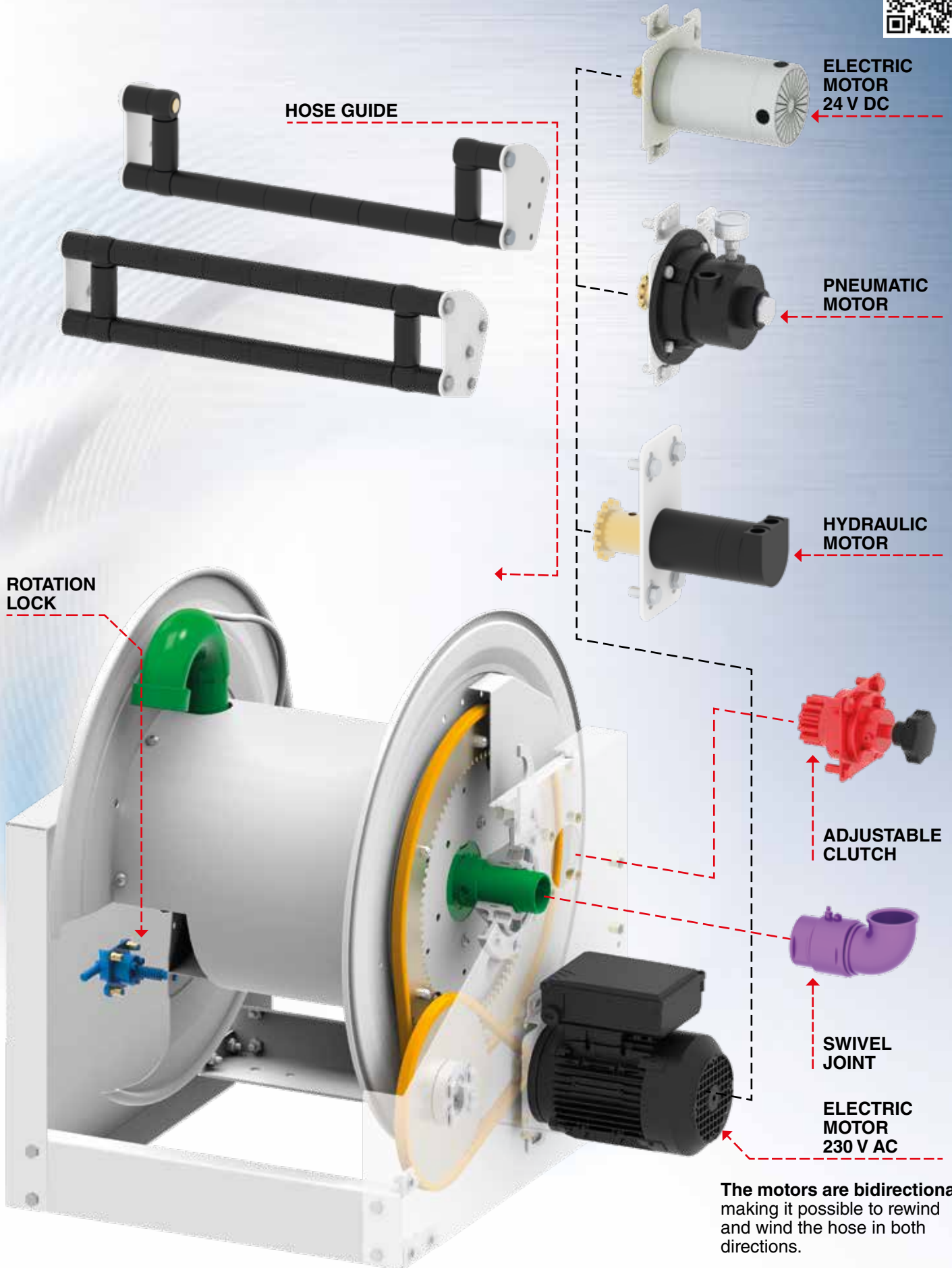

The motors are bidirectional:
making it possible to rewind
and wind the hose in both
directions.



Type of fluid
AIR-WATER

Pressure
20 bar

Material
PAINTED STEEL

MOTORIZED

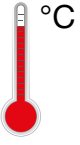

without hose, max. 100 °C



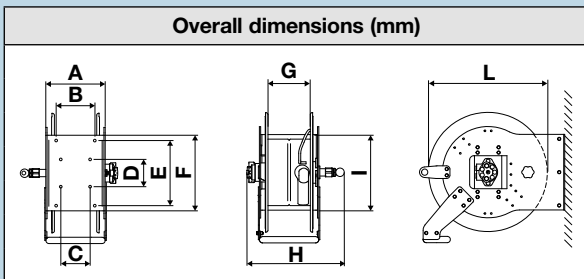

Seals	Swivel joint	Central pin
Viton®	brass	galvanized steel
	aluminum (s. 700)	
		

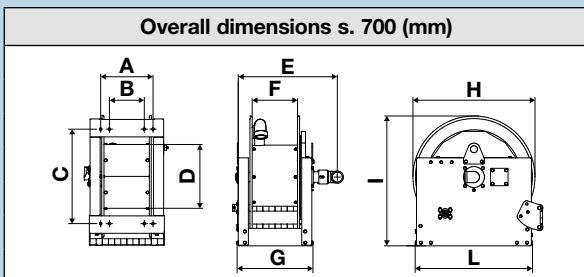

Series	A	B	C	D	E	F	G	H	I	L	Packaging (mm) W x D x H
617	283	185	140	130	310	360	200	465	317	570	 670 x 610 x 760
618	283	185	140	130	310	360	200	560	317	570	670 x 610 x 760
637	467	370	140	130	310	360	390	650	317	570	810 x 670 x 760
638	467	370	140	130	310	360	390	730	317	570	810 x 670 x 760

(W: width - D: depth - H: height)



Drum W	A	B	C	D	E	F	G	H	I	L	Packaging (mm) W x D x H
270	300	200	542	365	570	260	435	700	760	670	 820 x 770 x 845
410	440	340	542	365	712	398	575	700	760	670	875 x 845 x 820
550	580	480	542	365	850	538	717	700	760	670	1030 x 830 x 830
690	720	620	542	365	990	680	855	700	760	670	1170 x 830 x 845

(W: width - D: depth - H: height)



P/N	Drum external width (mm)	Connection		Weight
		inlet	outlet	

HYDRAULIC

s. 617	8617.100	220	G 1" (f)		G 1" (f)	63,0 kg
Hose reel capacity	inner hose ø	3/8"	1/2"	5/8"	3/4"	1"
	max. length	90 m	65 m	45 m	30 m	20 m
s. 637	8637.100	400	G 1" (f)		G 1" (f)	85,0 kg
Hose reel capacity	inner hose ø	3/8"	1/2"	5/8"	3/4"	1"
	max. length	200 m	150 m	110 m	75 m	50 m

PNEUMATIC



s. 618	8618.100	220	G 1" (f)		G 1" (f)	70,4 kg
Hose reel capacity	inner hose ø	3/8"	1/2"	5/8"	3/4"	1"
	max. length	90 m	65 m	45 m	30 m	20 m
s. 638	8638.100	400	G 1" (f)		G 1" (f)	92,4 kg
Hose reel capacity	inner hose ø	3/8"	1/2"	5/8"	3/4"	1"
	max. length	200 m	150 m	110 m	75 m	50 m

ELECTRIC 24 V DC

s. 700	7721301.100	270	G 2" (f)	G 2" (f)	105,0 kg
	7741301.100	410	G 2" (f)	G 2" (f)	111,0 kg
	7751301.100	550	G 2" (f)	G 2" (f)	116,0 kg
	7771301.100	690	G 2" (f)	G 2" (f)	121,7 kg

ELECTRIC 230 V AC - 50 Hz

s. 700	7721601.100	270	G 2" (f)	G 2" (f)	110,0 kg
	7741601.100	410	G 2" (f)	G 2" (f)	116,0 kg
	7751601.100	550	G 2" (f)	G 2" (f)	120,8 kg
	7771601.100	690	G 2" (f)	G 2" (f)	126,5 kg

ELECTRIC 230 V AC - 50 Hz (with standard clutch)   II 3 GD

s. 700	7721702.100	270	G 2" (f)	G 2" (f)	112,6 kg
	7741702.100	410	G 2" (f)	G 2" (f)	118,4 kg
	7751702.100	550	G 2" (f)	G 2" (f)	123,4 kg
	7771702.100	690	G 2" (f)	G 2" (f)	129,1 kg

HYDRAULIC

s. 700	7721801.100	270	G 2" (f)	G 2" (f)	100,0 kg
	7741801.100	410	G 2" (f)	G 2" (f)	106,3 kg
	7751801.100	550	G 2" (f)	G 2" (f)	111,3 kg
	7771801.100	690	G 2" (f)	G 2" (f)	117,0 kg

PNEUMATIC
(This series is in accordance with ATEX directive II 3GD if ordered with clutch P/N 77/2F)

s. 700	7721901.100	270	G 2" (f)	G 2" (f)	104,2 kg
	7741901.100	410	G 2" (f)	G 2" (f)	110,0 kg
	7751901.100	550	G 2" (f)	G 2" (f)	115,0 kg
	7771901.100	690	G 2" (f)	G 2" (f)	120,7 kg

Hose reel capacity s. 700	inner hose ø	3/8"	1/2"	3/4"	1"	1.1/4"	1.1/2"	2"
	drum width 270	160 m	110 m	65 m	30 m	20 m	15 m	10 m
	drum width 410	290 m	180 m	120 m	60 m	35 m	30 m	20 m
	drum width 550	420 m	280 m	180 m	100 m	60 m	50 m	30 m
	drum width 690	550 m	350 m	244 m	134 m	84 m	75 m	43 m



Type of fluid
HOT WATER

Pressure
70-100 bar

Material
PAINTED STEEL

MOTORIZED

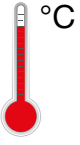

without hose, max. 130 °C

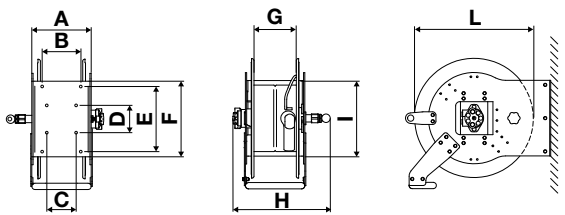

Seals	Swivel joint	Central pin
Viton®	AISI 304 s. steel	galvanized steel (s. 600)
	AISI 316 s. steel	AISI 316 s. steel (s. 700)
		

Overall dimensions (mm)	Series	A	B	C	D	E	F	G	H	I	L	Packaging (mm) W x D x H
		617	283	185	140	130	310	360	200	465	317	
	618	283	185	140	130	310	360	200	560	317	570	670 x 610 x 760
	637	467	370	140	130	310	360	390	650	317	570	810 x 670 x 760
	638	467	370	140	130	310	360	390	730	317	570	810 x 670 x 760

(W: width - D: depth - H: height)

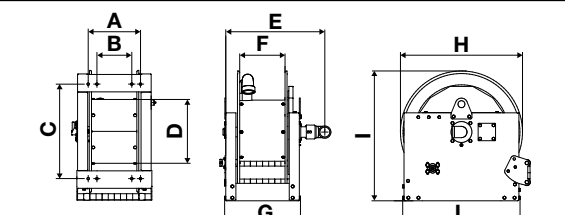
Overall dimensions s. 700 (mm)	Drum W	A	B	C	D	E	F	G	H	I	L	Packaging (mm) W x D x H
		270	300	200	542	365	570	260	435	700	760	
	410	440	340	542	365	712	398	575	700	760	670	875 x 845 x 820
	550	580	480	542	365	850	538	717	700	760	670	1030 x 830 x 830
	690	720	620	542	365	990	680	855	700	760	670	1170 x 830 x 845

(W: width - D: depth - H: height)



P/N	Drum external width (mm)	Connection		Weight
		inlet	outlet	

HYDRAULIC

s. 617 100 bar	8617.200	220	G 1" (f)	G 1" (f)	63,0 kg
--------------------------	-----------------	-----	----------	----------	---------

Hose reel capacity	inner hose ø	3/8"	1/2"	5/8"	3/4"	1"
	max. length	90 m	65 m	45 m	30 m	20 m

s. 637 100 bar	8637.200	400	G 1" (f)	G 1" (f)	85,0 kg
--------------------------	-----------------	-----	----------	----------	---------

Hose reel capacity	inner hose ø	3/8"	1/2"	5/8"	3/4"	1"
	max. length	200 m	150 m	110 m	75 m	50 m

PNEUMATIC

s. 618 100 bar	8618.200	220	G 1" (f)	G 1" (f)	70,4 kg
--------------------------	-----------------	-----	----------	----------	---------



Hose reel capacity	inner hose ø	3/8"	1/2"	5/8"	3/4"	1"
	max. length	90 m	65 m	45 m	30 m	20 m

s. 638 100 bar	8638.200	400	G 1" (f)	G 1" (f)	92,4 kg
--------------------------	-----------------	-----	----------	----------	---------

Hose reel capacity	inner hose ø	3/8"	1/2"	5/8"	3/4"	1"
	max. length	200 m	150 m	110 m	75 m	50 m

**ELECTRIC 230 V AC - 50 Hz
PASSAGE AND SWIVEL JOINT IN AISI 316 STAINLESS STEEL**

s. 700 70 bar	7726601.200	270	G 2" (f)	G 2" (f)	110,0 kg
	7746601.200	410	G 2" (f)	G 2" (f)	116,0 kg
	7756601.200	550	G 2" (f)	G 2" (f)	120,8 kg

**ELECTRIC 230 V AC - 50 Hz (with standard clutch)
PASSAGE AND SWIVEL JOINT IN AISI 316 STAINLESS STEEL**  

s. 700 70 bar	7726702.200	270	G 2" (f)	G 2" (f)	112,8 kg
	7756702.200	550	G 2" (f)	G 2" (f)	123,6 kg

PNEUMATIC - PASSAGE AND SWIVEL JOINT IN AISI 316 STAINLESS STEEL
(This series is in accordance with ATEX directive II 3GD if ordered with clutch P/N 77/2F)

s. 700 70 bar	7746901.200	410	G 2" (f)	G 2" (f)	110,0 kg
-------------------------	--------------------	-----	----------	----------	----------

Hose reel capacity s. 700	inner hose ø	3/8"	1/2"	3/4"	1"	1.1/4"	1.1/2"	2"
	drum width 270	160 m	110 m	65 m	30 m	20 m	15 m	10 m
	drum width 410	290 m	180 m	120 m	60 m	35 m	30 m	20 m
	drum width 550	420 m	280 m	180 m	100 m	60 m	50 m	30 m
	drum width 690	550 m	350 m	244 m	134 m	84 m	75 m	43 m



Type of fluid
HOT WATER

Pressure
70 bar



Material
- AISI 304 S. STEEL
- AISI 316 S. STEEL

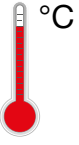

MOTORIZED



without hose, max. 130 °C

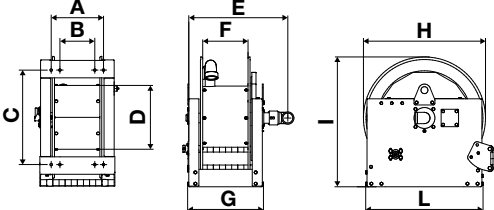

	WASTE OIL	OIL AND SIMILAR	DIESEL	Seals	Swivel joint	Central pin
				Viton®	stainless steel AISI 304-316	stainless steel AISI 304-316
						

Overall dimensions s. 700 (mm)			Drum W	A	B	C	D	E	F	G	H	I	L	Packaging (mm) W x D x H
	270	300	200	542	365	570	260	200	700	760	670		820 x 770 x 845	
	410	440	340	542	365	712	398	200	700	760	670		875 x 845 x 820	
	550	580	480	542	365	850	538	390	700	760	670		1030 x 830 x 830	
	690	720	620	542	365	990	680	390	700	760	670		1170 x 830 x 845	

(W: width - D: depth - H: height)





P/N in AISI 304 stainless steel	P/N in AISI 316 stainless steel	Drum external width (mm)	Connection		Weight
			inlet	outlet	

ELECTRIC 24 V DC

s. 700	7724301.200	7725301.200	270	G 2" (f)	G 2" (f)	105,0 kg
	7744301.200	7745301.200	410	G 2" (f)	G 2" (f)	111,0 kg
	7754301.200	7755301.200	550	G 2" (f)	G 2" (f)	116,0 kg
	7774301.200	7775301.200	690	G 2" (f)	G 2" (f)	121,7 kg

ELECTRIC 230 V AC - 50 Hz

s. 700	7724601.200	7725601.200	270	G 2" (f)	G 2" (f)	110,0 kg
	7744601.200	7745601.200	410	G 2" (f)	G 2" (f)	116,0 kg
	7754601.200	7755601.200	550	G 2" (f)	G 2" (f)	120,8 kg
	7774601.200	7775601.200	690	G 2" (f)	G 2" (f)	126,5 kg

ELECTRIC 230 V AC - 50 Hz (with standard clutch)   II 3 GD

s. 700 ATEX	7724702.200	7725702.200	270	G 2" (f)	G 2" (f)	112,8 kg
	7744702.200	7745702.200	410	G 2" (f)	G 2" (f)	118,8 kg
	7754702.200	7755702.200	550	G 2" (f)	G 2" (f)	123,6 kg
	7774702.200	7775702.200	690	G 2" (f)	G 2" (f)	129,3 kg

HYDRAULIC

s. 700	7724801.200	7725801.200	270	G 2" (f)	G 2" (f)	100,0 kg
	7744801.200	7745801.200	410	G 2" (f)	G 2" (f)	106,3 kg
	7754801.200	7755801.200	550	G 2" (f)	G 2" (f)	111,3 kg
	7774801.200	7775801.200	690	G 2" (f)	G 2" (f)	117,0 kg

PNEUMATIC
(This series is in accordance with ATEX directive II 3GD if ordered with clutch P/N 77/3F - 77/4F)

s. 700	7724901.200	7725901.200	270	G 2" (f)	G 2" (f)	104,2 kg
	7744901.200	7745901.200	410	G 2" (f)	G 2" (f)	110,0 kg
	7754901.200	7755901.200	550	G 2" (f)	G 2" (f)	115,0 kg
	7774901.200	7775901.200	690	G 2" (f)	G 2" (f)	120,7 kg

Hose reel capacity s. 700	inner hose ø	3/8"	1/2"	3/4"	1"	1.1/4"	1.1/2"	2"
	drum width 270	160 m	110 m	65 m	30 m	20 m	15 m	10 m
	drum width 410	290 m	180 m	120 m	60 m	35 m	30 m	20 m
	drum width 550	420 m	280 m	180 m	100 m	60 m	50 m	30 m
	drum width 690	550 m	350 m	244 m	134 m	84 m	75 m	43 m



Type of fluid
**OIL AND
SIMILAR**

Pressure
70-150 bar

Material
PAINTED STEEL

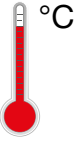

MOTORIZED





without hose, max. 80 °C

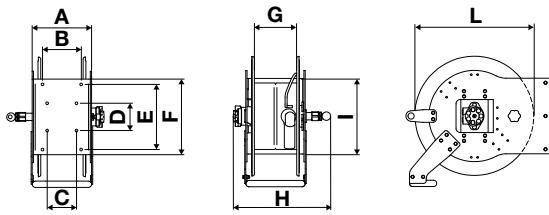

	Seals	Swivel joint	Central pin
S. 600	polyurethane	galvanized steel	galvanized steel
S. 700	Viton®		
			

Overall dimensions (mm)			Series	A	B	C	D	E	F	G	H	I	L	Packaging (mm) W x D x H
	617	283	185	140	130	310	360	200	465	317	570		670 x 710 x 760	
	618	283	185	140	130	310	360	200	560	317	570		670 x 710 x 760	
	637	467	370	140	130	310	360	390	650	317	570		810 x 670 x 760	
	638	467	370	140	130	310	360	390	730	317	570		810 x 670 x 760	

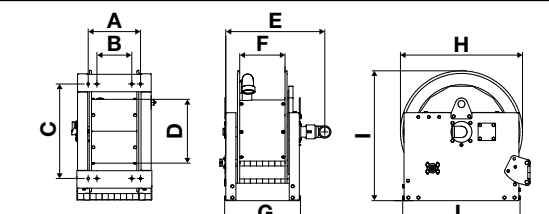
(W: width - D: depth - H: height)

Overall dimensions s. 700 (mm)			Drum W	A	B	C	D	E	F	G	H	I	L	Packaging (mm) W x D x H
	270	300	200	542	365	570	260	422	700	760	659		820 x 770 x 845	
	410	440	340	542	365	710	398	562	700	760	659		875 x 845 x 820	
	550	580	480	542	365	850	538	702	700	760	659		1030 x 830 x 830	
	690	720	620	542	365	990	680	842	700	760	659		1170 x 830 x 845	

(W: width - D: depth - H: height)



P/N	Drum external width (mm)	Connection		Weight
		inlet	outlet	

HYDRAULIC

s. 617 150 bar	8617.400	220	G 1" (f)	G 1" (f)	63,0 kg
--------------------------	-----------------	-----	----------	----------	---------

Hose reel capacity	inner hose ø	3/8"	1/2"	5/8"	3/4"	1"
	max. length	90 m	65 m	45 m	30 m	20 m

s. 637 150 bar	8637.400	400	G 1" (f)	G 1" (f)	85,0 kg
--------------------------	-----------------	-----	----------	----------	---------

Hose reel capacity	inner hose ø	3/8"	1/2"	5/8"	3/4"	1"
	max. length	200 m	150 m	110 m	75 m	50 m

PNEUMATIC

s. 618 150 bar	8618.400	220	G 1" (f)	G 1" (f)	70,4 kg
--------------------------	-----------------	-----	----------	----------	---------

Hose reel capacity	inner hose ø	3/8"	1/2"	5/8"	3/4"	1"
	max. length	90 m	65 m	45 m	30 m	20 m

s. 638 150 bar	8638.400	400	G 1" (f)	G 1" (f)	92,4 kg
--------------------------	-----------------	-----	----------	----------	---------



Hose reel capacity	inner hose ø	3/8"	1/2"	5/8"	3/4"	1"
	max. length	200 m	150 m	110 m	75 m	50 m

ELECTRIC 24 V DC

s. 700 70 bar	7721301.400	270	G 2" (f)	G 2" (f)	105,0 kg
	7741301.400	410	G 2" (f)	G 2" (f)	111,0 kg
	7751301.400	550	G 2" (f)	G 2" (f)	116,0 kg
	7771301.400	690	G 2" (f)	G 2" (f)	121,7 kg

ELECTRIC 230 V AC - 50 Hz

s. 700 70 bar	7721601.400	270	G 2" (f)	G 2" (f)	110,0 kg
	7741601.400	410	G 2" (f)	G 2" (f)	116,0 kg
	7751601.400	550	G 2" (f)	G 2" (f)	120,8 kg
	7771601.400	690	G 2" (f)	G 2" (f)	126,5 kg

ELECTRIC 230 V AC - 50 Hz (with standard clutch)   **II 3 GD**

s. 700 70 bar	7721702.400	270	G 2" (f)	G 2" (f)	112,6 kg
	7741702.400	410	G 2" (f)	G 2" (f)	118,4 kg
	7751702.400	550	G 2" (f)	G 2" (f)	123,4 kg
	7771702.400	690	G 2" (f)	G 2" (f)	129,1 kg

HYDRAULIC

s. 700 70 bar	7721801.400	270	G 2" (f)	G 2" (f)	100,0 kg
	7741801.400	410	G 2" (f)	G 2" (f)	106,3 kg
	7751801.400	550	G 2" (f)	G 2" (f)	111,3 kg
	7771801.400	690	G 2" (f)	G 2" (f)	117,0 kg

PNEUMATIC
(This series is in accordance with ATEX directive II 3GD if ordered with clutch P/N 77/2F)

s. 700 70 bar	7721901.400	270	G 2" (f)	G 2" (f)	104,2 kg
	7741901.400	410	G 2" (f)	G 2" (f)	110,0 kg
	7751901.400	550	G 2" (f)	G 2" (f)	115,0 kg
	7771901.400	690	G 2" (f)	G 2" (f)	120,7 kg

Hose reel capacity s. 700	inner hose ø	3/8"	1/2"	3/4"	1"	1.1/4"	1.1/2"	2"
	drum width 270	160 m	110 m	65 m	30 m	20 m	15 m	10 m
	drum width 410	290 m	180 m	120 m	60 m	35 m	30 m	20 m
	drum width 550	420 m	280 m	180 m	100 m	60 m	50 m	30 m
	drum width 690	550 m	350 m	244 m	134 m	84 m	75 m	43 m



Type of fluid
GREASE

Pressure
400 bar

Material
PAINTED STEEL

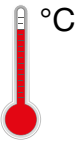

MOTORIZED



without hose, max. 80 °C

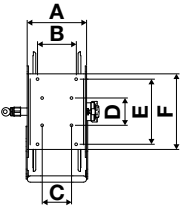
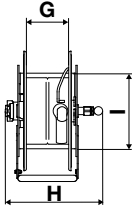
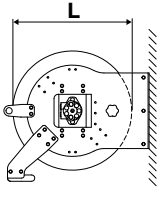

Seals	Swivel joint	Central pin
polyurethane	galvanized steel	galvanized steel
		

Overall dimensions (mm)			Series	A	B	C	D	E	F	G	H	I	L	Packaging (mm) W x D x H
  	617	283	185	140	130	310	360	200	465	317	570		670 x 610 x 760	
	618	283	185	140	130	310	360	200	560	317	570		670 x 610 x 760	
	637	467	370	140	130	310	360	390	650	317	570		810 x 670 x 760	
	638	467	370	140	130	310	360	390	730	317	570		810 x 670 x 760	

(W: width - D: depth - H: height)



P/N	Drum external width (mm)	Connection		Weight
		inlet	outlet	

HYDRAULIC

s. 617	8617.500	220	G 1" (f)	G 1" (f)	63,0 kg
---------------	-----------------	-----	----------	----------	---------

Hose reel capacity	inner hose Ø	3/8"	1/2"	5/8"	3/4"	1"
	max. length	90 m	65 m	45 m	30 m	20 m

s. 637	8637.500	400	G 1" (f)	G 1" (f)	85,0 kg
---------------	-----------------	-----	----------	----------	---------

Hose reel capacity	inner hose Ø	3/8"	1/2"	5/8"	3/4"	1"
	max. length	200 m	150 m	110 m	75 m	50 m

PNEUMATIC

s. 618	8618.500	220	G 1" (f)	G 1" (f)	70,4 kg
---------------	-----------------	-----	----------	----------	---------

Hose reel capacity	inner hose Ø	3/8"	1/2"	5/8"	3/4"	1"
	max. length	90 m	65 m	45 m	30 m	20 m

s. 638	8638.500	400	G 1" (f)	G 1" (f)	92,4 kg
---------------	-----------------	-----	----------	----------	---------

Hose reel capacity	inner hose Ø	3/8"	1/2"	5/8"	3/4"	1"
	max. length	200 m	150 m	110 m	75 m	50 m



Type of fluid
DIESEL

Pressure
20 bar

Material
PAINTED STEEL

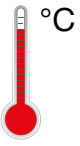

MOTORIZED



without hose, max. 100 °C

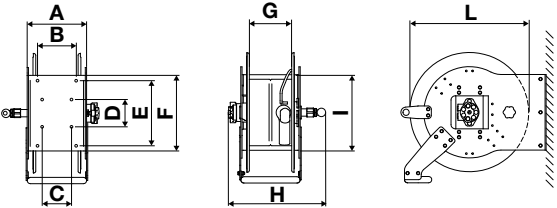

Seals	Swivel joint	Central pin
Viton®	brass	galvanized steel
	aluminum (s. 700)	
		

Overall dimensions (mm)			Series	A	B	C	D	E	F	G	H	I	L	Packaging (mm) W x D x H	
	617	283	185	140	130	310	360	200	465	317	570		670 x 710 x 760		
	618	283	185	140	130	310	360	200	560	317	570		670 x 710 x 760		
	637	467	370	140	130	310	360	390	650	317	570		810 x 670 x 760		
	638	467	370	140	130	310	360	390	730	317	570		810 x 670 x 760		

(W: width - D: depth - H: height)

Overall dimensions s. 700 (mm)			Drum W	A	B	C	D	E	F	G	H	I	L	Packaging (mm) W x D x H	
	270	300	200	542	365	570	260	435	700	760	670		820 x 770 x 845		
	410	440	340	542	365	712	398	575	700	760	670		875 x 845 x 820		
	550	580	480	542	365	850	538	717	700	760	670		1030 x 830 x 830		
	690	720	620	542	365	990	680	855	700	760	670		1170 x 830 x 845		

(W: width - D: depth - H: height)



P/N	Drum external width (mm)	Connection		Weight
		inlet	outlet	

HYDRAULIC

s. 617	8617.600	220	G 1.1/2" (f)	G 1.1/2" (f)	63,0 kg
---------------	-----------------	-----	--------------	--------------	---------

Hose reel capacity	inner hose ø	3/8"	1/2"	5/8"	3/4"	1"	1.1/4"	1.1/2"
	max. length	90 m	65 m	45 m	30 m	20 m	15 m	10 m

s. 637	8637.600	400	G 1.1/2" (f)	G 1.1/2" (f)	85,0 kg
---------------	-----------------	-----	--------------	--------------	---------

Hose reel capacity	inner hose ø	3/8"	1/2"	5/8"	3/4"	1"	1.1/4"	1.1/2"
	max. length	200 m	150 m	110 m	75 m	50 m	30 m	20 m

PNEUMATIC

s. 618	8618.100	220	G 1" (f)	G 1" (f)	70,4 kg
---------------	-----------------	-----	----------	----------	---------

Hose reel capacity	inner hose ø	3/8"	1/2"	5/8"	3/4"	1"
	max. length	90 m	65 m	45 m	30 m	20 m

s. 638	8638.100	400	G 1" (f)	G 1" (f)	92,4 kg
---------------	-----------------	-----	----------	----------	---------



Hose reel capacity	inner hose ø	3/8"	1/2"	5/8"	3/4"	1"
	max. length	200 m	150 m	110 m	75 m	50 m

ELECTRIC 24 V DC

s. 700	7721301.100	270	G 2" (f)	G 2" (f)	105,0 kg
	7741301.100	410	G 2" (f)	G 2" (f)	111,0 kg
	7751301.100	550	G 2" (f)	G 2" (f)	116,0 kg
	7771301.100	690	G 2" (f)	G 2" (f)	121,7 kg

ELECTRIC 230 V AC - 50 Hz

s. 700	7721601.100	270	G 2" (f)	G 2" (f)	110,0 kg
	7741601.100	410	G 2" (f)	G 2" (f)	116,8 kg
	7751601.100	550	G 2" (f)	G 2" (f)	120,8 kg
	7771601.100	690	G 2" (f)	G 2" (f)	126,8 kg

ELECTRIC 230 V AC - 50 Hz (with standard clutch)   II 3 GD

s. 700	7721702.100	270	G 2" (f)	G 2" (f)	112,6 kg
	7741702.100	410	G 2" (f)	G 2" (f)	118,4 kg
	7751702.100	550	G 2" (f)	G 2" (f)	123,4 kg
	7771702.100	690	G 2" (f)	G 2" (f)	129,1 kg

HYDRAULIC

s. 700	7721801.100	270	G 2" (f)	G 2" (f)	100,0 kg
	7741801.100	410	G 2" (f)	G 2" (f)	106,3 kg
	7751801.100	550	G 2" (f)	G 2" (f)	111,3 kg
	7771801.100	690	G 2" (f)	G 2" (f)	117,0 kg

PNEUMATIC

s. 700	7721901.100	270	G 2" (f)	G 2" (f)	104,2 kg
	7741901.100	410	G 2" (f)	G 2" (f)	110,0 kg
	7751901.100	550	G 2" (f)	G 2" (f)	115,0 kg
	7771901.100	690	G 2" (f)	G 2" (f)	120,7 kg

Hose reel capacity s. 700	inner hose ø	3/8"	1/2"	3/4"	1"	1.1/4"	1.1/2"	2"
	drum width 270	160 m	110 m	65 m	30 m	20 m	15 m	10 m
	drum width 410	290 m	180 m	120 m	60 m	35 m	30 m	20 m
	drum width 550	420 m	280 m	180 m	100 m	60 m	50 m	30 m
	drum width 690	550 m	350 m	244 m	134 m	84 m	75 m	43 m

ACCESSORIES FOR MOTORIZED HOSE REELS - SERIES 700

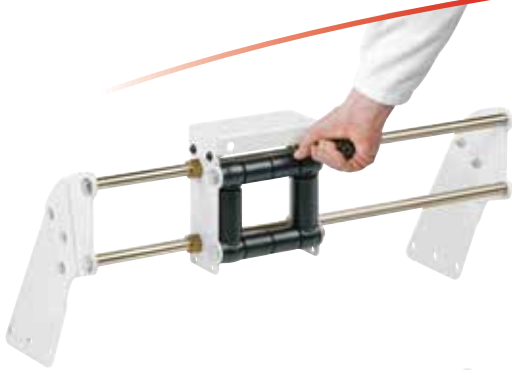

High manual operation hose guide

P/N 77/22775B for width 270 mm
P/N 77/24175B for width 410 mm
P/N 77/25575B for width 550 mm
P/N 77/26975B for width 690 mm

By operating the special handle, the operator moves the hose to the right or left, ensuring correct rewinding.



Low manual operation hose guide

P/N 77/22775 for width 270 mm
P/N 77/24175 for width 410 mm
P/N 77/25575 for width 550 mm
P/N 77/26975 for width 690 mm



Standard closed hose guide, high

P/N 77/12775B for width 270 mm
P/N 77/14175B for width 410 mm
P/N 77/15575B for width 550 mm
P/N 77/16975B for width 690 mm

Hose guide with rollers that allow the hose to slide easily during unwinding and rewinding operations.



Standard closed hose guide, low

P/N 77/12775 for width 270 mm
P/N 77/14175 for width 410 mm
P/N 77/15575 for width 550 mm
P/N 77/16975 for width 690 mm



Standard open hose guide, high

P/N 77/32775B for width 270 mm
P/N 77/34175B for width 410 mm
P/N 77/35575B for width 550 mm
P/N 77/36975B for width 690 mm

This type of hose guide allows for installation of both versions (high and low) on the same hose reel, thus allowing hose unwinding in two opposing directions.



Standard open hose guide, low

P/N 77/32775 for width 270 mm
P/N 77/34175 for width 410 mm
P/N 77/35575 for width 550 mm
P/N 77/36975 for width 690 mm



P/N 77/2F Painted steel free fall clutch permits controlled unwinding of the hose and switches to neutral during rewinding phase.

P/N 77/3F Free fall clutch in AISI 316 stainless steel permits controlled unwinding of the hose and switches to neutral during rewinding phase.

P/N 77/4F Free fall clutch in AISI 304 stainless steel permits controlled unwinding of the hose and switches to neutral during rewinding phase.

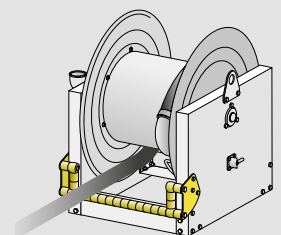
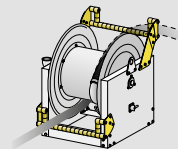
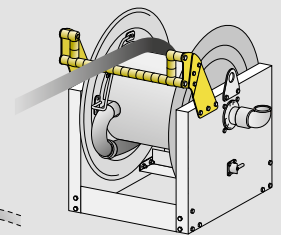
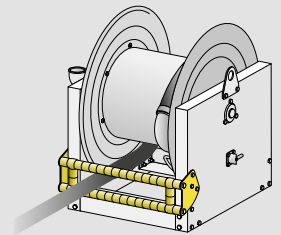
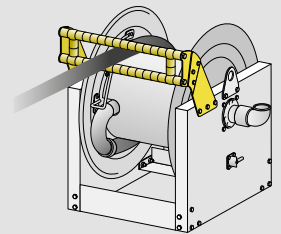
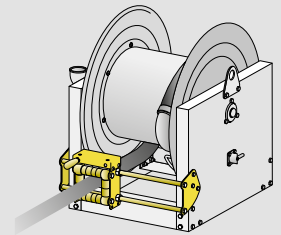
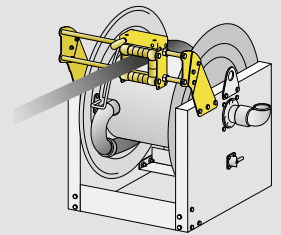

HOSES

TECHNICAL DATA



STRENGTH POINTS

The range of hoses offered by RAASM for its hose reels is in line with company's quality standards and guarantees superb performance in applications with the pressures specified in the catalogue.

For conditions other than those recommended, RAASM will work with the customer to evaluate each and every aspect of the pertinent application (material compatibility with the fluid, working temperature, operating pressure, etc.) to determine the best hose for each specific case.



The hoses mounted on the hose reels must be suitable to handle the operating pressures indicated on the hose reel's label.

HOSES: TECHNICAL DATA



CONNECTION HOSE FOR HOSE REEL - SYSTEM INTERCONNECTION

P/N	Pressure	Hose length	Hose characteristics	Hose \varnothing	Dimensions - internal \varnothing x external \varnothing	Inlet	Outlet	Connections
987.205	10 bar	0,6 m	antistatic EPDM	3/4"	19 x 27 mm	G 3/4" (f)	G 1/2" (m)	AISI 316 s. steel
987.206	10 bar	0,6 m	antistatic EPDM	3/4"	19 x 27 mm	G 3/4" (f)	G 1" (m)	AISI 316 s. steel
995.106	10 bar	0,6 m	atoxic hygienic	3/8"	10 x 17 mm	G 3/8" (m)	G 3/8" (f)	galvanized steel
996.106	10 bar	0,6 m	atoxic hygienic	1/2"	13 x 20 mm	G 1/2" (m)	G 1/2" (f)	galvanized steel
997.806	10 bar	0,6 m	black rubber	3/4"	19 x 27 mm	G 1/2" (m)	G 3/4" (f)	galvanized steel
998.106	10 bar	0,6 m	atoxic hygienic	1"	25 x 35 mm	G 1" (m)	G 1" (f)	galvanized steel
972.102	20 bar	1,5 m	polyurethane	10 x 14,5	10 x 14,5 mm	G 3/8" (m)	G 3/8" (f)	brass
975.1002	20 bar	1,5 m	NBR/PVC	3/8"	10 x 17 mm	G 3/8" (f) LH	G 3/8" (f) LH	brass
975.902	20 bar	1,5 m	SBR/EPDM	2 x 3/8"	9 + 9 x 16 mm	G 3/8" (f)	G 3/8" (f)	brass
976.102	20 bar	1,5 m	polyurethane	13 x 19	13 x 19 mm	G 1/2" (f)	G 1/2" (m)	brass
993.201	20 bar	1 m	black rubber	1/4"	6,4 x 13 mm	G 1/4" (f)	G 1/4" (m)	galvanized steel
993.202	20 bar	2 m	black rubber	1/4"	6,4 x 13 mm	G 1/4" (f)	G 1/4" (m)	galvanized steel
995.206	20 bar	0,6 m	black rubber	3/8"	9,5 x 16 mm	G 3/8" (f)	G 3/8" (m)	galvanized steel
998.305	50 bar	0,6 m	black rubber	1"	25,4 x 31,5 mm	G 1" (m)	G 1" (f)	galvanized steel
998.3301	50 bar	1 m	black rubber	1"	25,4 x 31,5 mm	G 1" (f)	G 1" (m)	galvanized steel
998.3302	50 bar	2 m	black rubber	1"	25,4 x 31,5 mm	G 1" (f)	G 1" (m)	galvanized steel
998.3306	50 bar	0,6 m	black rubber	1"	25,4 x 31,5 mm	G 1" (f)	G 1" (m)	galvanized steel
998.406	50 bar	0,6 m	hygienic	1"	24,5 x 31,5 mm	G 1" (f)	G 1" (m)	galvanized steel
998.806	50 bar	0,6 m	black rubber	1"	25 x 35 mm	G 1" (m)	G 1" (f)	galvanized steel
996.305	100 bar	0,6 m	black rubber	1/2"	12,7 x 19 mm	G 1/2" (m)	G 1/2" (f)	galvanized steel
997.3305	100 bar	5 m	black rubber	3/4"	19 x 26,5 mm	G 3/4" (f)	G 3/4" (m)	galvanized steel
997.3306	100 bar	0,6 m	black rubber	3/4"	19 x 26,5 mm	G 1/2" (m)	G 3/4" (f)	galvanized steel
996.406	100 bar	0,6 m	hygienic	1/2"	12,7 x 18,5 mm	G 1/2" (f)	G 1/2" (m)	galvanized steel
995.301	150 bar	1,2 m	black rubber	3/8"	9,5 x 16 mm	G 3/8" (m)	G 3/8" (f)	galvanized steel
996.301	150 bar	1 m	black rubber	1/2"	12,7 x 19 mm	G 1/2" (f)	G 1/2" (m)	galvanized steel
996.3015	150 bar	1,5 m	black rubber	1/2"	12,7 x 19 mm	G 1/2" (m)	G 1/2" (f)	galvanized steel
996.302	150 bar	2 m	black rubber	1/2"	12,7 x 19 mm	G 1/2" (f)	G 1/2" (f)	galvanized steel
996.304	150 bar	4 m	black rubber	1/2"	12,7 x 19 mm	G 1/2" (f)	G 1/2" (m)	galvanized steel
996.306	150 bar	0,6 m	black rubber	1/2"	12,7 x 19 mm	G 1/2" (f)	G 1/2" (m)	galvanized steel
995.506	200 bar	0,6 m	black rubber	3/8"	9,5 x 17 mm	G 3/8" (f)	G 3/8" (m)	galvanized steel
995.606	200 bar	0,6 m	hygienic	3/8"	9,5 x 17 mm	G 3/8" (f)	G 3/8" (m)	galvanized steel
993.504	400 bar	4 m	black rubber	1/4"	6,3 x 17,5 mm	G 1/4" (f)	G 1/4" (m)	galvanized steel
995.701	400 bar	1 m	black rubber	3/8"	9,5 x 18 mm	G 3/8" (f)	G 3/8" (m)	galvanized steel
995.702	400 bar	2 m	black rubber	3/8"	9,5 x 18 mm	G 3/8" (f)	G 3/8" (m)	galvanized steel
995.706	400 bar	0,6 m	black rubber	3/8"	9,5 x 18 mm	G 3/8" (f)	G 3/8" (m)	galvanized steel
995.806	400 bar	0,6 m	black rubber	3/8"	9,5 x 17,5 mm	G 3/8" (f)	G 3/8" (m)	galvanized steel
995.906	400 bar	0,6 m	hygienic	3/8"	9,5 x 17,5 mm	G 3/8" (f)	G 3/8" (m)	galvanized steel

Air-water 10 bar

P/N	Hose length	Hose characteristics	Max. working temperature	Hose ø	Dimensions - internal ø x external ø	Inlet	Outlet	Connections
995.112	12 m	atoxic hygienic	95 °C	3/8"	10 x 17 mm	G 3/8" (m)	G 3/8" (f)	galvanized steel
996.110	10 m	atoxic hygienic	95 °C	1/2"	13 x 20 mm	G 1/2" (m)	G 1/2" (f)	galvanized steel
996.116	15 m	atoxic hygienic	95 °C	1/2"	13 x 20 mm	G 1/2" (m)	G 1/2" (f)	galvanized steel
996.120	20 m	atoxic hygienic	95 °C	1/2"	13 x 20 mm	G 1/2" (m)	G 1/2" (f)	galvanized steel
996.125	25 m	atoxic hygienic	95 °C	1/2"	13 x 20 mm	G 1/2" (m)	G 1/2" (f)	galvanized steel
996.130	30 m	atoxic hygienic	95 °C	1/2"	13 x 20 mm	G 1/2" (m)	G 1/2" (f)	galvanized steel
997.115	15 m	atoxic hygienic	95 °C	3/4"	19 x 27 mm	G 3/4" (m)	G 3/4" (f)	galvanized steel
997.120	20 m	atoxic hygienic	95 °C	3/4"	19 x 27 mm	G 3/4" (m)	G 3/4" (f)	galvanized steel
997.130	30 m	atoxic hygienic	95 °C	3/4"	19 x 27 mm	G 3/4" (m)	G 3/4" (f)	galvanized steel
997.140	40 m	atoxic hygienic	95 °C	3/4"	19 x 27 mm	G 3/4" (m)	G 3/4" (f)	galvanized steel
998.115	15 m	atoxic hygienic	95 °C	1"	25 x 35 mm	G 1" (m)	G 1" (f)	galvanized steel
998.120	20 m	atoxic hygienic	95 °C	1"	25 x 35 mm	G 1" (m)	G 1" (f)	galvanized steel
998.130	30 m	atoxic hygienic	95 °C	1"	25 x 35 mm	G 1" (m)	G 1" (f)	galvanized steel

Air-water 20 bar

P/N	Hose length	Hose characteristics	Max. working temperature	Hose ø	Dimensions - internal ø x external ø	Inlet	Outlet	Connections
971.010	10 m	polyurethane	60 °C	1/4"	6 x 10 mm	G 3/8" (m)	G 1/4" (m)	brass
971.011	11 m	polyurethane	60 °C	1/4"	6 x 10 mm	G 1/4" (m)	G 1/4" (m)	brass
971.015	15 m	polyurethane	60 °C	1/4"	6 x 10 mm	G 3/8" (m)	G 1/4" (m)	brass
971.111	11 m	polyurethane	60 °C	5/16"	8 x 12 mm	G 1/4" (m)	G 1/4" (m)	brass
971.115	15 m	polyurethane	60 °C	5/16"	6 x 12 mm	G 3/8" (m)	G 1/4" (m)	brass
971.118	18 m	polyurethane	60 °C	5/16"	8 x 12 mm	G 3/8" (m)	G 1/4" (m)	brass
971.120	20 m	polyurethane	60 °C	5/16"	8 x 12 mm	G 3/8" (m)	G 1/4" (m)	brass
972.113	13 m	polyurethane	60 °C	3/8"	10 x 14,5 mm	G 3/8" (m)	G 3/8" (m)	brass
972.115	15 m	polyurethane	60 °C	3/8"	10 x 14,5 mm	G 3/8" (m)	G 3/8" (m)	brass
972.120	20 m	polyurethane	60 °C	3/8"	10 x 14,5 mm	G 3/8" (m)	G 3/8" (m)	brass
976.108	8 m	polyurethane	60 °C	1/2"	13 x 19 mm	G 1/2" (m)	G 1/2" (m)	brass
976.110	10 m	polyurethane	60 °C	1/2"	13 x 19 mm	G 1/2" (m)	G 1/2" (m)	brass
976.111	10 m	polyurethane	60 °C	1/2"	13 x 19 mm	G 1/2" (f)	G 1/2" (m)	brass
976.112	12 m	polyurethane	60 °C	1/2"	13 x 19 mm	G 1/2" (m)	G 1/2" (m)	brass
976.114	15 m	polyurethane	60 °C	1/2"	13 x 19 mm	G 1/2" (m)	G 1/2" (m)	brass
976.115	15 m	polyurethane	60 °C	1/2"	13 x 19 mm	G 1/2" (f)	G 1/2" (m)	brass
993.215	15 m	black rubber	80 °C	1/4"	6,5 x 12,6 mm	G 3/8" (m)	G 1/4" (m)	galvanized steel
995.210	10 m	black rubber	80 °C	3/8"	9,5 x 17 mm	G 3/8" (m)	G 3/8" (m)	galvanized steel
995.211	12 m	black rubber	80 °C	3/8"	9,5 x 16 mm	G 3/8" (m)	G 3/8" (m)	galvanized steel
995.212	12 m	black rubber	80 °C	3/8"	9,5 x 16 mm	G 3/8" (f)	G 3/8" (m)	galvanized steel
995.217	18 m	black rubber	80 °C	3/8"	9,5 x 16 mm	G 3/8" (m)	G 3/8" (m)	galvanized steel
995.218	18 m	black rubber	80 °C	3/8"	9,5 x 16 mm	G 3/8" (f)	G 3/8" (m)	galvanized steel
996.210	10 m	black rubber	80 °C	1/2"	12,7 x 20 mm	G 1/2" (f)	G 1/2" (m)	galvanized steel
996.215	15 m	black rubber	80 °C	1/2"	12,7 x 20 mm	G 1/2" (f)	G 1/2" (m)	galvanized steel
996.220	20 m	black rubber	80 °C	1/2"	12,7 x 20 mm	G 1/2" (f)	G 1/2" (m)	galvanized steel
996.225	25 m	black rubber	80 °C	1/2"	12,7 x 20 mm	G 1/2" (f)	G 1/2" (m)	galvanized steel
996.230	30 m	black rubber	80 °C	1/2"	12,7 x 20 mm	G 1/2" (f)	G 1/2" (m)	galvanized steel
997.215	15 m	black rubber	80 °C	3/4"	19 x 26,5 mm	G 3/4" (f)	G 3/4" (m)	galvanized steel
997.220	20 m	black rubber	80 °C	3/4"	19 x 26,5 mm	G 3/4" (f)	G 3/4" (m)	galvanized steel
997.230	30 m	black rubber	80 °C	3/4"	19 x 26,5 mm	G 3/4" (f)	G 3/4" (m)	galvanized steel
997.240	40 m	black rubber	80 °C	3/4"	19 x 26,5 mm	G 3/4" (f)	G 3/4" (m)	galvanized steel
998.215	15 m	black rubber	80 °C	1"	25,4 x 32,5 mm	G 1" (f)	G 1" (m)	galvanized steel
998.220	20 m	black rubber	80 °C	1"	25,4 x 32,5 mm	G 1" (f)	G 1" (m)	galvanized steel
998.230	30 m	black rubber	80 °C	1"	25,4 x 32,5 mm	G 1" (f)	G 1" (m)	galvanized steel

Hot water 50 bar

P/N	Hose length	Hose characteristics	Max. working temperature	Hose ø	Dimensions - internal ø x external ø	Inlet	Outlet	Connections
998.315	15 m	black rubber	80 °C	1"	25,4 x 31,5 mm	G 1" (f)	G 1" (m)	galvanized steel
998.330	30 m	black rubber	80 °C	1"	25,4 x 31,5 mm	G 1" (f)	G 1" (m)	galvanized steel

Hot water 100 bar

P/N	Hose length	Hose characteristics	Max. working temperature	Hose ø	Dimensions - internal ø x external ø	Inlet	Outlet	Connections
995.313	12 m	black rubber	80 °C	3/8"	9,5 x 15 mm	G 3/8" (m)	G 3/8" (m)	galvanized steel
995.318	17 m	black rubber	80 °C	3/8"	9,5 x 15 mm	G 3/8" (m)	G 3/8" (m)	galvanized steel
995.412	12 m	hygienic	130 °C	3/8"	9,5 x 15 mm	G 3/8" (m)	G 3/8" (m)	galvanized steel
996.311	10 m	black rubber	80 °C	1/2"	12,7 x 18,5 mm	G 1/2" (f)	G 1/2" (m)	galvanized steel
996.316	15 m	black rubber	80 °C	1/2"	12,7 x 18,5 mm	G 1/2" (f)	G 1/2" (m)	galvanized steel
996.321	20 m	black rubber	80 °C	1/2"	12,7 x 18,5 mm	G 1/2" (f)	G 1/2" (m)	galvanized steel
996.415	15 m	hygienic	130 °C	1/2"	12,7 x 18,5 mm	G 1/2" (f)	G 1/2" (m)	galvanized steel
996.425	25 m	hygienic	130 °C	1/2"	12,7 x 18,5 mm	G 1/2" (f)	G 1/2" (m)	galvanized steel
997.320	20 m	black rubber	80 °C	3/4"	19 x 25 mm	G 3/4" (f)	G 3/4" (m)	galvanized steel
997.420	20 m	hygienic	130 °C	3/4"	19 x 25 mm	G 3/4" (f)	G 3/4" (m)	galvanized steel

Hot water 200 bar

P/N	Hose length	Hose characteristics	Max. working temperature	Hose ø	Dimensions - internal ø x external ø	Inlet	Outlet	Connections
994.512	12 m	black rubber	130 °C	5/16"	8 x 15 mm	G 3/8" (m)	G 3/8" (f)	galvanized steel
994.517	17 m	black rubber	130 °C	5/16"	8 x 15 mm	G 3/8" (m)	G 3/8" (f)	galvanized steel
994.612	12 m	hygienic	130 °C	5/16"	8 x 15 mm	G 3/8" (m)	G 3/8" (f)	galvanized steel
995.512	12 m	black rubber	130 °C	3/8"	9,5 x 17 mm	G 3/8" (f)	G 3/8" (f)	galvanized steel
995.518	18 m	black rubber	130 °C	3/8"	9,5 x 17 mm	G 3/8" (f)	G 3/8" (f)	galvanized steel
995.520	20 m	black rubber	130 °C	3/8"	9,5 x 17 mm	G 3/8" (f)	G 3/8" (f)	galvanized steel
995.525	25 m	black rubber	130 °C	3/8"	9,5 x 17 mm	G 3/8" (f)	G 3/8" (f)	galvanized steel
995.530	30 m	black rubber	130 °C	3/8"	9,5 x 17 mm	G 3/8" (f)	G 3/8" (f)	galvanized steel
995.540	40 m	black rubber	130 °C	3/8"	9,5 x 17 mm	G 3/8" (f)	G 3/8" (f)	galvanized steel
995.550	50 m	black rubber	130 °C	3/8"	9,5 x 17 mm	G 3/8" (f)	G 3/8" (f)	galvanized steel
995.618	18 m	hygienic	130 °C	3/8"	9,5 x 17 mm	G 3/8" (f)	G 3/8" (f)	galvanized steel
995.625	25 m	hygienic	130 °C	3/8"	9,5 x 17 mm	G 3/8" (f)	G 3/8" (f)	galvanized steel
995.630	30 m	hygienic	130 °C	3/8"	9,5 x 17 mm	G 3/8" (f)	G 3/8" (f)	galvanized steel

Hot water 400 bar

P/N	Hose length	Hose characteristics	Max. working temperature	Hose ø	Dimensions - internal ø x external ø	Inlet	Outlet	Connections
994.717	17 m	black rubber	130 °C	5/16"	8 x 16 mm	G 3/8" (m)	G 3/8" (f)	galvanized steel
995.815	15 m	black rubber	130 °C	3/8"	9,5 x 17,5 mm	G 3/8" (f)	G 3/8" (f)	galvanized steel
995.820	20 m	black rubber	130 °C	3/8"	9,5 x 17,5 mm	G 3/8" (f)	G 3/8" (f)	galvanized steel
995.825	25 m	black rubber	130 °C	3/8"	9,5 x 17,5 mm	G 3/8" (f)	G 3/8" (f)	galvanized steel
995.915	15 m	hygienic	130 °C	3/8"	9,5 x 17,5 mm	G 3/8" (f)	G 3/8" (f)	galvanized steel
995.925	25 m	hygienic	130 °C	3/8"	9,5 x 17,5 mm	G 3/8" (f)	G 3/8" (f)	galvanized steel

Oil and similar 50 bar

P/N	Hose length	Hose characteristics	Max. working temperature	Hose ø	Dimensions - internal ø x external ø	Inlet	Outlet	Connections
998.3310	10 m	black rubber	80 °C	1"	25,4 x 33,5 mm	G 1" (m)	G 1" (f)	galvanized steel
998.3315	15 m	black rubber	80 °C	1"	25,4 x 33,5 mm	G 1" (f)	G 1" (m)	galvanized steel
998.3320	20 m	black rubber	80 °C	1"	25,4 x 33,5 mm	G 1" (m)	G 1" (f)	galvanized steel
998.3330	30 m	black rubber	80 °C	1"	25,4 x 33,5 mm	G 1" (f)	G 1" (m)	galvanized steel

Oil and similar 100 bar

P/N	Hose length	Hose characteristics	Max. working temperature	Hose ø	Dimensions - internal ø x external ø	Inlet	Outlet	Connections
997.3308	8 m	black rubber	80 °C	3/4"	19 x 26,5 mm	G 3/4" (m)	G 1/2" (f)	galvanized steel
997.3312	12 m	black rubber	80 °C	3/4"	19 x 26,5 mm	G 3/4" (m)	G 3/4" (f)	galvanized steel
997.3315	15 m	black rubber	80 °C	3/4"	19 x 26,5 mm	G 3/4" (f)	G 3/4" (m)	galvanized steel
997.3320	20 m	black rubber	80 °C	3/4"	19 x 26,5 mm	G 3/4" (f)	G 3/4" (m)	galvanized steel
997.3330	30 m	black rubber	80 °C	3/4"	19 x 26,5 mm	G 3/4" (m)	G 3/4" (f)	galvanized steel
997.3340	40 m	black rubber	80 °C	3/4"	19 x 26,5 mm	G 3/4" (m)	G 3/4" (f)	galvanized steel
999.3310	10 m	black rubber	80 °C	5/8"	16 x 23 mm	G 1/2" (f)	G 3/4" (m)	galvanized steel

Oil and similar 150 bar

P/N	Hose length	Hose characteristics	Max. working temperature	Hose ø	Dimensions - internal ø x external ø	Inlet	Outlet	Connections
995.312	12 m	black rubber	80 °C	3/8"	9,5 x 16 mm	G 3/8" (m)	G 1/2" (m)	galvanized steel
995.317	17 m	black rubber	80 °C	3/8"	9,5 x 16 mm	G 3/8" (m)	G 1/2" (m)	galvanized steel
996.310	10 m	black rubber	80 °C	1/2"	12,7 x 19 mm	G 1/2" (f)	G 1/2" (m)	galvanized steel
996.315	15 m	black rubber	80 °C	1/2"	12,7 x 19 mm	G 1/2" (f)	G 1/2" (m)	galvanized steel
996.320	20 m	black rubber	80 °C	1/2"	12,7 x 19 mm	G 1/2" (f)	G 1/2" (m)	galvanized steel
996.325	25 m	black rubber	80 °C	1/2"	12,7 x 19 mm	G 1/2" (f)	G 1/2" (m)	galvanized steel
996.330	30 m	black rubber	80 °C	1/2"	12,7 x 19 mm	G 1/2" (f)	G 1/2" (m)	galvanized steel

Grease 400 bar

P/N	Hose length	Hose characteristics	Max. working temperature	Hose ø	Dimensions - internal ø x external ø	Inlet	Outlet	Connections
993.511	12 m	black rubber	80 °C	1/4"	6,3 x 17,5 mm	G 3/8" (m)	G 1/4" (m)	galvanized steel
993.512	12 m	black rubber	80 °C	1/4"	6,3 x 17,5 mm	G 1/4" (f)	G 1/4" (m)	galvanized steel
993.516	16 m	black rubber	80 °C	1/4"	6,3 x 17,5 mm	G 3/8" (m)	G 1/4" (m)	galvanized steel
993.518	18 m	black rubber	80 °C	1/4"	6,3 x 17,5 mm	G 1/4" (f)	G 1/4" (m)	galvanized steel
995.710	10 m	black rubber	80 °C	3/8"	9,5 x 18 mm	G 3/8" (f)	G 1/4" (m)	galvanized steel
995.715	15 m	black rubber	80 °C	3/8"	9,5 x 18 mm	G 3/8" (f)	G 1/4" (m)	galvanized steel
995.720	20 m	black rubber	80 °C	3/8"	9,5 x 18 mm	G 3/8" (f)	G 1/4" (m)	galvanized steel
995.725	25 m	black rubber	80 °C	3/8"	9,5 x 18 mm	G 3/8" (f)	G 1/4" (m)	galvanized steel
995.730	30 m	black rubber	80 °C	3/8"	9,5 x 18 mm	G 3/8" (f)	G 1/4" (m)	galvanized steel

Diesel 10 bar

P/N	Hose length	Hose characteristics	Max. working temperature	Hose ø	Dimensions - internal ø x external ø	Inlet	Outlet	Connections
997.808	8 m	black rubber	80 °C	3/4"	19 x 27 mm	G 1/2" (f)	G 3/4" (m)	galvanized steel
997.812	12 m	black rubber	80 °C	3/4"	19 x 27 mm	G 1/2" (f)	G 1/2" (m)	galvanized steel
997.815	15 m	black rubber	80 °C	3/4"	19 x 27 mm	G 3/4" (f)	G 3/4" (m)	galvanized steel
997.820	20 m	black rubber	80 °C	3/4"	19 x 27 mm	G 3/4" (f)	G 3/4" (m)	galvanized steel
997.840	40 m	black rubber	80 °C	3/4"	19 x 27 mm	G 3/4" (f)	G 3/4" (m)	galvanized steel
998.808	8 m	black rubber	80 °C	1"	25 x 35 mm	G 1" (f)	G 1" (m)	galvanized steel
998.815	15 m	black rubber	80 °C	1"	25 x 35 mm	G 1" (f)	G 1" (m)	galvanized steel
998.820	20 m	black rubber	80 °C	1"	25 x 35 mm	G 1" (f)	G 1" (m)	galvanized steel
998.830	30 m	black rubber	80 °C	1"	25 x 35 mm	G 1" (f)	G 1" (m)	galvanized steel
999.810	10 m	black rubber	80 °C	5/8"	16 x 23 mm	G 1/2" (f)	G 3/4" (m)	galvanized steel

AdBlue® 10 bar

P/N	Hose length	Hose characteristics	Max. working temperature	Hose ø	Dimensions - internal ø x external ø	Inlet	Outlet	Connections
987.208	8 m	Antistatic EPDM	80 °C	3/4"	19 x 27 mm	G 1/2" (f)	G 3/4" (m)	AISI 316 s. steel
987.210	10 m	Antistatic EPDM	80 °C	3/4"	19 x 27 mm	G 3/4" (f)	G 3/4" (m)	AISI 316 s. steel
987.215	15 m	Antistatic EPDM	80 °C	3/4"	19 x 27 mm	G 3/4" (f)	G 3/4" (m)	AISI 316 s. steel

Welding 20 bar - EN ISO 3821

P/N	Hose length	Hose characteristics	Hose ø	Dimensions - internal ø x external ø	Inlet	Outlet	Connections
973.913	13 m	SBR/EPDM	2 x 1/4"	2 x (6,3 x 13) mm	G 3/8" (f)	G 3/8" (f)	brass
973.917	17 m	SBR/EPDM	2 x 1/4"	2 x (6,3 x 13) mm	G 3/8" (f)	G 3/8" (f)	brass
973.920	20 m	SBR/EPDM	2 x 1/4"	2 x (6,3 x 13) mm	G 3/8" (f)	G 3/8" (f)	brass
973.925	25 m	SBR/EPDM	2 x 1/4"	2 x (6,3 x 13) mm	G 3/8" (f)	G 3/8" (f)	brass
973.930	30 m	SBR/EPDM	2 x 1/4"	2 x (6,3 x 13) mm	G 3/8" (f)	G 3/8" (f)	brass
974.912	12 m	SBR/EPDM	2 x 5/16"	2 x (8 x 15) mm	G 3/8" (f)	G 3/8" (f)	brass
974.915	15 m	SBR/EPDM	2 x 5/16"	2 x (8 x 15) mm	G 3/8" (f)	G 3/8" (f)	brass
974.920	20 m	SBR/EPDM	2 x 5/16"	2 x (8 x 15) mm	G 3/8" (f)	G 3/8" (f)	brass
974.925	25 m	SBR/EPDM	2 x 5/16"	2 x (8 x 15) mm	G 3/8" (f)	G 3/8" (f)	brass
974.930	30 m	SBR/EPDM	2 x 5/16"	2 x (8 x 15) mm	G 3/8" (f)	G 3/8" (f)	brass
975.915	15 m	SBR/EPDM	2 x 3/8"	2 x (9 x 16) mm	G 3/8" (f)	G 3/8" (f)	brass
975.920	20 m	SBR/EPDM	2 x 3/8"	2 x (9 x 16) mm	G 3/8" (f)	G 3/8" (f)	brass
975.927	27 m	SBR/EPDM	2 x 3/8"	2 x (9 x 16) mm	G 3/8" (f)	G 3/8" (f)	brass

LPG-methane 20 bar - EN ISO 3821

P/N	Hose length	Hose characteristics	Hose ø	Dimensions - internal ø x external ø	Inlet	Outlet	Connections
974.1008	8 m	NBR/PVC	5/16"	8 x 15 mm	G 3/8" (f) LH	G 3/8" (f) LH	brass
974.1015	15 m	NBR/PVC	5/16"	8 x 15 mm	G 3/8" (f) LH	G 3/8" (f) LH	brass
974.1020	20 m	NBR/PVC	5/16"	8 x 15 mm	G 3/8" (f) LH	G 3/8" (f) LH	brass
974.1028	28 m	NBR/PVC	5/16"	8 x 15 mm	G 3/8" (f) LH	G 3/8" (f) LH	brass
975.1010	10 m	NBR/PVC	3/8"	10 x 17 mm	G 3/8" (f) LH	G 3/8" (f) LH	brass
975.1015	15 m	NBR/PVC	3/8"	10 x 17 mm	G 3/8" (f) LH	G 3/8" (f) LH	brass
975.1018	18 m	NBR/PVC	3/8"	10 x 17 mm	G 3/8" (f) LH	G 3/8" (f) LH	brass
975.1027	27 m	NBR/PVC	3/8"	10 x 17 mm	G 3/8" (f) LH	G 3/8" (f) LH	brass
975.1030	30 m	NBR/PVC	3/8"	10 x 17 mm	G 3/8" (f) LH	G 3/8" (f) LH	brass

HOSE STOP

Adapters for hoses of different diameters (supplied with the hose stop).

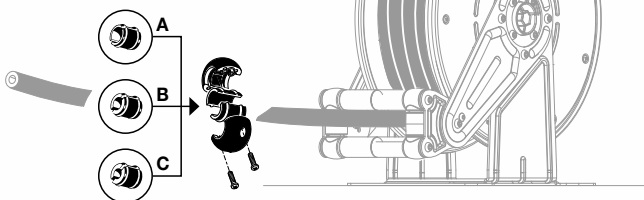

Universal hose stop, supplied with all hose reels that come without hose, complete with adapters for the use of different diameter hoses.

P/N	Hose reel series		ø Reduction
KR7201	290 - 330	Painted - Stainless steel	12 - 14 - 16 mm
	380 - 390		
KR8104	420 - 430 - 440	Painted - Stainless steel	14 - 17 - 19 mm
	450 - 520 - 530		
KR8705	540 - 550 - 560	Painted - Stainless steel	14 - 17,5 - 21 28,5 - 30 - 34 mm
KR8907	420 - 520 - 540	Twin hose	12 - 14 - 15 - 16 mm

FITTINGS TO CONNECT HOSES EXITING THE HOSE REEL



Nipple, carbon steel		
Article	Thread dimensions	Thread type
33114	G 1" (m) x G 1/2" (m)	cylindrical/cylindrical thread
33116	G 1" (m) x G 1" (m)	cylindrical/cylindrical thread
33117	G 3/4" (m) x G 3/4" (m)	cylindrical/cylindrical thread
33118	G 1/2" (m) x G 3/4" (m)	tapered/cylindrical thread
33119	G 1" (m) x G 3/4" (m)	cylindrical/cylindrical thread
33270	G 1.1/2" (m) x G 3/4" (m)	cylindrical/cylindrical thread
33271	G 1.1/2" (m) x G 1" (m)	cylindrical/cylindrical thread
33272	G 1.1/2" (m) x G 1.1/4" (m)	cylindrical/cylindrical thread
33273	G 1.1/2" (m) x G 1.1/4" (f)	cylindrical/cylindrical thread
33274	G 1" (m) x G 1/2" (m)	cylindrical/cylindrical thread
38071	G 1/2" (m) x G 1/2" (m)	tapered/cylindrical thread
38072	G 1/2" (m) x G 3/8" (m)	cylindrical/cylindrical thread
38073	G 3/8" (m) x G 3/8" (m)	tapered/cylindrical thread
38074	G 1/2" (m) x G 1/2" (m)	cylindrical/cylindrical thread
66891	G 1/4" (m) x G 1/4" (m)	tapered/cylindrical thread
66892	G 1/4" (m) x G 3/8" (m)	cylindrical/cylindrical thread
66893	G 1/2" (m) x G 1/4" (m)	cylindrical/cylindrical thread

Nipple, AISI 304 stainless steel		
Article	Thread dimensions	Thread type
33128	G 1" (m) x G 3/4" (m)	cylindrical/cylindrical thread
33129	G 1" (m) x G 1" (m)	cylindrical/cylindrical thread
33130	G 3/4" (m) x G 3/4" (m)	cylindrical/cylindrical thread
38120	G 1/2" (m) x G 3/8" (m)	cylindrical/cylindrical thread
38121	G 1/2" (m) x G 1/2" (m)	cylindrical/cylindrical thread
38122	G 1/2" (m) x G 3/8" (m)	cylindrical/cylindrical thread
38123	G 1/2" (m) x G 3/8" (m)	tapered/cylindrical thread
38124	G 1/2" (m) x G 1/2" (m)	tapered/cylindrical thread

Nipple, AISI 316 stainless steel		
Article	Thread dimensions	Thread type
33131	G 1" (m) x G 3/4" (m)	cylindrical/cylindrical thread
33132	G 1" (m) x G 1" (m)	cylindrical/cylindrical thread
33133	G 1" (m) x G 1/2" (m)	cylindrical/cylindrical thread
38125	G 1/2" (m) x G 3/4" (m)	cylindrical/cylindrical thread

CONNECTING HOSES EXITING THE HOSE REEL

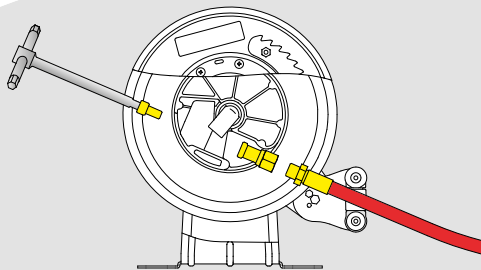

Series 290 - 330 - 380 - 390

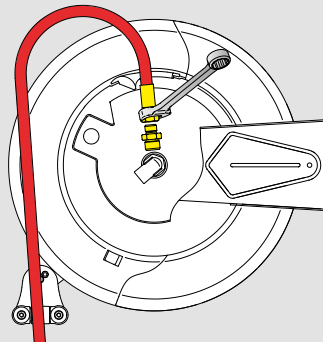

Series 420 - 430 - 520 - 530

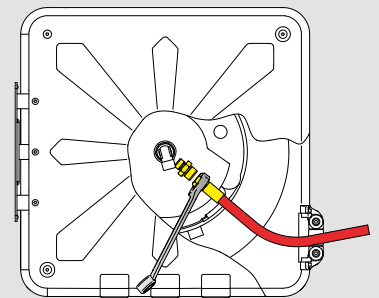

Series 440 - 450

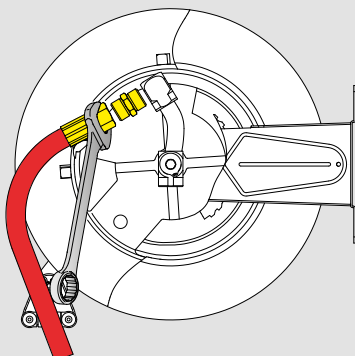

Series 540-550-560
outlet 1"

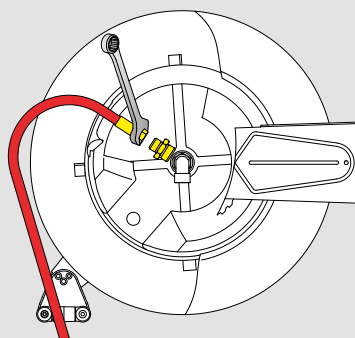

Series 540-550-560
outlet 1/2"

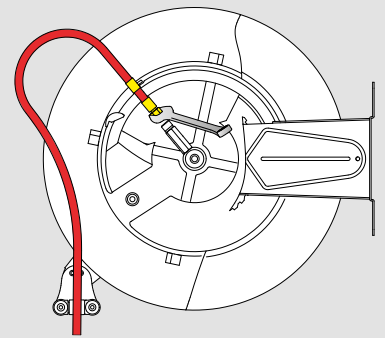

Welding-gas series



**ADVANCED FLUID
MANAGEMENT SOLUTIONS**

SPRING OPERATED ELECTRIC CABLE REELS



EXAMPLES OF **USE**

AUTOMOTIVE

MINING
INDUSTRY

MANUFACTUR-
ING INDUSTRY

AERONAUTICS

BUILDING
AND ROAD
CONSTRUCTION

...and much more



POWER PNEUMATIC EQUIPMENT ON CONSTRUCTION SITES

MAINTENANCE OF WINE CELLAR PRODUCTION EQUIPMENT

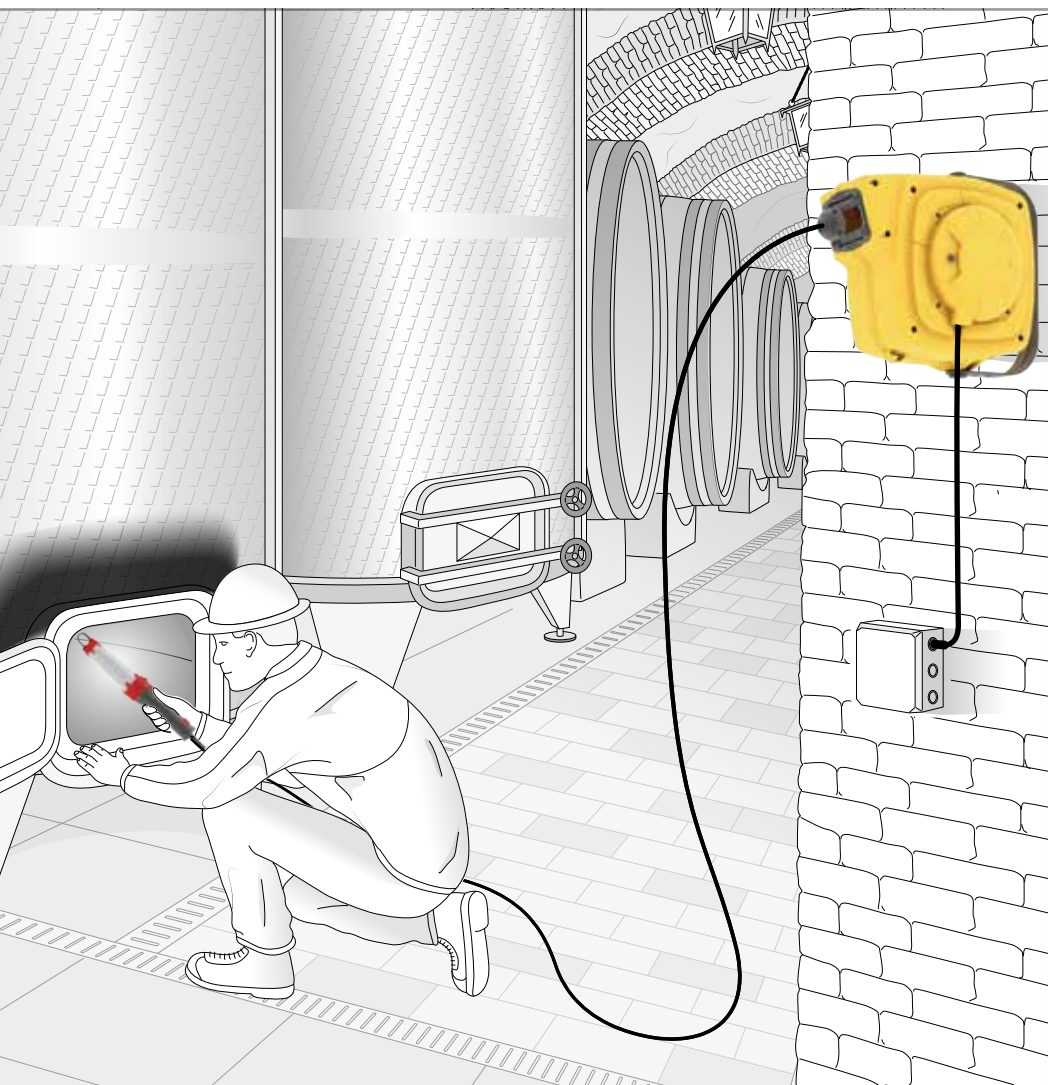



**ADVANCED FLUID
MANAGEMENT SOLUTIONS**

SPRING OPERATED --- ELECTRIC CABLE REELS

STRENGTH POINTS

- Special electric collector to drastically reduce overheating during operation.
- Thermal protector standard on all models.
- IP64 protection degree standard on all models (IP65 if equipped with protection cap).
- An optional protection degree is available, useful to protect against accidental, uncontrolled rewinding of the cable.
- Cable guide with rollers, horizontal and vertical, on 4 sides, designed to extend average cable life, comes standard on all models.
- Repeated spring stress-tests guarantees decades of life and efficiency.



TECHNICAL CHARACTERISTICS

Visit our
website

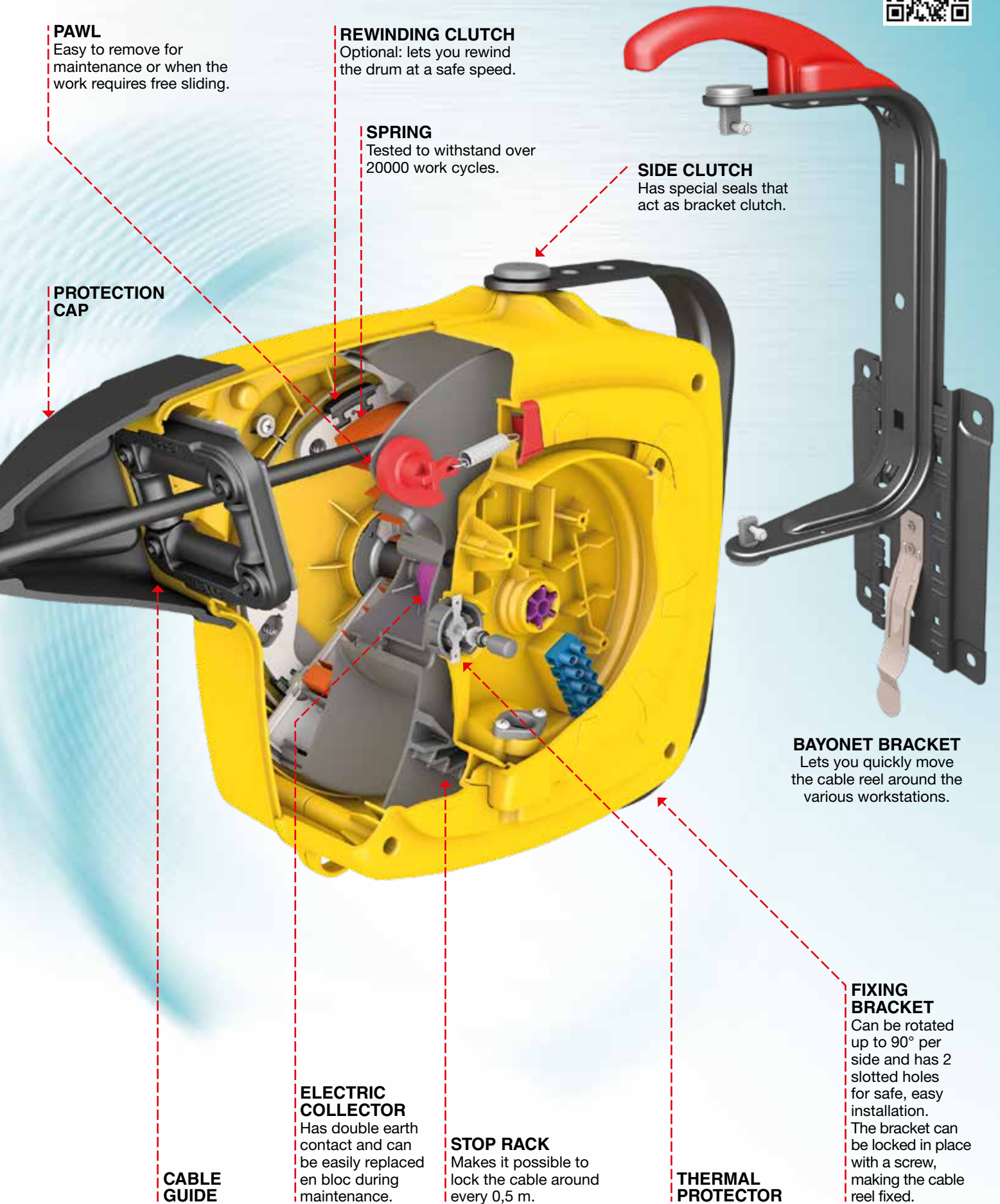

PAWL
Easy to remove for maintenance or when the work requires free sliding.

REWINDING CLUTCH
Optional: lets you rewind the drum at a safe speed.

SPRING
Tested to withstand over 20000 work cycles.

SIDE CLUTCH
Has special seals that act as bracket clutch.

PROTECTION CAP

BAYONET BRACKET
Lets you quickly move the cable reel around the various workstations.

ELECTRIC COLLECTOR
Has double earth contact and can be easily replaced en bloc during maintenance.

STOP RACK
Makes it possible to lock the cable around every 0,5 m.

FIXING BRACKET
Can be rotated up to 90° per side and has 2 slotted holes for safe, easy installation. The bracket can be locked in place with a screw, making the cable reel fixed.

CABLE GUIDE

THERMAL PROTECTOR



Series
280

Type
**extension
cord**

Power supply
230 V SINGLE PHASE

WITH SPRING



**FIXED AND
SWIVELLING**

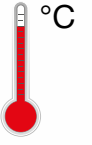

environment working
temperature -5 ÷ +40 °C

THERMAL PROTECTOR

standard

INPUT CABLE

1,2 m

COVER COLOURS

Shockproof plastic



Number of conductors 2	Number of conductors 3	Electrical protection rating
<p>EN 61242 2014/35/EU 2014/30/EU 2011/65/EU</p>	<p>EN 61242 2014/35/EU 2014/30/EU 2011/65/EU</p>	<p>IP64 without cap IP65 with cap</p> <p>Warning, the system IP rating is reduced according that of the connected components.</p>

Overall dimensions without bracket (mm)	Overall dimensions with bracket (mm)	Packaging (mm) W x D x H
		440 x 195 x 485 No. 40 packages per pallet

(W: width - D: depth - H: height)



P/N standard	Number of conductors	Type of cable	Cable length	Max. operating power (20 °C)		Weight
				Wound up	Unwound *	
2210	2	2 x 1 - H05 VV-F	17 + 1 m	0,9 kW	1,4 kW	6,8 kg
3210	2	2 x 1 - H07 RN-F	12 + 1 m	0,9 kW	1,4 kW	6,9 kg
2215	2	2 x 1,5 - H05 VV-F	15 + 1 m	1,1 kW	2,3 kW	7,0 kg
2225	2	2 x 2,5 - H05 VV-F	10 + 1 m	1,9 kW	3,5 kW	7,1 kg
2310	3	3G x 1 - H05 VV-F	14 + 1 m	0,9 kW	1,4 kW	6,8 kg
3310	3	3G x 1 - H07 RN-F	10 + 1 m	0,9 kW	1,4 kW	7,0 kg
2315	3	3G x 1,5 - H05 VV-F	14 + 1 m	1,2 kW	2,3 kW	7,2 kg
3315	3	3G x 1,5 - H07 RN-F	9 + 1 m	1,2 kW	2,3 kW	7,2 kg
2325	3	3G x 2,5 - H05 VV-F	9 + 1 m	1,9 kW	3,5 kW	7,3 kg
3325	3	3G x 2,5 - H07 RN-F	7 + 1 m	1,9 kW	3,5 kW	7,4 kg

⚠ The codes above are supplied without accessories: protection cap - bayonet bracket.

* Values are with cable completely unwound.

SPEED CONTROL

The versions listed below come with clutch so that cable rewinding can be performed at a controlled speed. They are marked by the **SPEED CONTROL** dataplate.



P/N with speed control	Number of conductors	Type of cable	Cable length	Max. operating power (20 °C)		Weight
				Wound up	Unwound *	
2210F	2	2 x 1 - H05 VV-F	17 + 1 m	0,9 kW	1,4 kW	7,2 kg
3210F	2	2 x 1 - H07 RN-F	12 + 1 m	0,9 kW	1,4 kW	7,3 kg
2215F	2	2 x 1,5 - H05 VV-F	15 + 1 m	1,1 kW	2,3 kW	7,4 kg
2225F	2	2 x 2,5 - H05 VV-F	10 + 1 m	1,9 kW	3,5 kW	7,5 kg
2310F	3	3G x 1 - H05 VV-F	14 + 1 m	0,9 kW	1,4 kW	7,2 kg
3310F	3	3G x 1 - H07 RN-F	10 + 1 m	0,9 kW	1,4 kW	7,4 kg
2315F	3	3G x 1,5 - H05 VV-F	14 + 1 m	1,2 kW	2,3 kW	7,6 kg
3315F	3	3G x 1,5 - H07 RN-F	9 + 1 m	1,2 kW	2,3 kW	7,6 kg
2325F	3	3G x 2,5 - H05 VV-F	9 + 1 m	1,9 kW	3,5 kW	7,7 kg
3325F	3	3G x 2,5 - H07 RN-F	7 + 1 m	1,9 kW	3,5 kW	7,8 kg

⚠ The codes above are supplied without accessories: protection cap - bayonet bracket.

* Values are with cable completely unwound.

ACCESSORIES FOR ELECTRIC CABLE REELS

P/N 728115
Protection cap, in oil resistant rubber, useful to protect against accidental entry of water or foreign objects into the cable reel.



P/N 89003
Bayonet bracket, lets you easily move the cable reel within the various workstations.



EXAMPLES OF ELECTRIC CABLE REELS



P/N with protection cap



P/N with bayonet bracket



P/N with speed control and protection cap



P/N with speed control and bayonet bracket



P/N with protection cap and bayonet bracket



P/N complete



Series
280

Type
**extension
cord**

Power supply
400 V THREE PHASE

WITH SPRING



**FIXED AND
SWIVELLING**

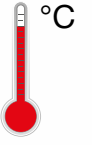

environment working
temperature -5 ÷ +40 °C

THERMAL PROTECTOR

standard

INPUT CABLE

1,2 m

COVER COLOURS

Shockproof plastic



Number of conductors 4 and 5	Electrical protection rating
<p>EN 61242 2014/35/EU 2014/30/EU 2011/65/EU</p>	<p>IP64 without cap IP65 with cap</p> <p>Warning, the system IP rating is reduced according that of the connected component.</p>

Overall dimensions without bracket (mm)	Overall dimensions with bracket (mm)	Packaging (mm) W x D x H
		440 x 195 x 485 No. 40 packages per pallet

(W: width - D: depth - H: height)



P/N standard	Number of conductors	Type of cable	Cable length	Max. operating power (20 °C)		Weight
				Wound up	Unwound *	
4410	4	4G x 1 - H05 VV-F	11 + 1 m	1,1 kW	2,3 kW	6,9 kg
4415	4	4G x 1,5 - H05 VV-F	10 + 1 m	1,4 kW	4 kW	7,2 kg
5415	4	4G x 1,5 - H07 RN-F	8 + 1 m	1,4 kW	4 kW	7,4 kg
4425	4	4G x 2,5 - H05 VV-F	8 + 1 m	2 kW	6 kW	7,6 kg
5425	4	4G x 2,5 - H07 RN-F	5 + 1 m	2 kW	6 kW	7,5 kg
4510	5	5G x 1 - H05 VV-F	11 + 1 m	1 kW	2,3 kW	7,2 kg
4517	5	5G x 1,5 - H05 VV-F	8 + 1 m	1,4 kW	4 kW	7,3 kg
5515	5	5G x 1,5 - H07 RN-F	7 + 1 m	1,4 kW	4 kW	7,7 kg

△ The codes above are supplied without accessories: protection cap - bayonet bracket.

* Values are with cable completely unwound.

SPEED CONTROL

The versions listed below come with clutch so that cable rewinding can be performed at a controlled speed. They are marked by the **SPEED CONTROL** dataplate.



P/N with speed control	Number of conductors	Type of cable	Cable length	Max. operating power (20 °C)		Weight
				Wound up	Unwound *	
4410F	4	4G x 1 - H05 VV-F	11 + 1 m	1,1 kW	2,3 kW	7,3 kg
4415F	4	4G x 1,5 - H05 VV-F	10 + 1 m	1,4 kW	4 kW	7,6 kg
5415F	4	4G x 1,5 - H07 RN-F	8 + 1 m	1,4 kW	4 kW	7,8 kg
4425F	4	4G x 2,5 - H05 VV-F	8 + 1 m	2 kW	6 kW	8,0 kg
5425F	4	4G x 2,5 - H07 RN-F	5 + 1 m	2 kW	6 kW	7,9 kg
4510F	5	5G x 1 - H05 VV-F	11 + 1 m	1 kW	2,3 kW	7,6 kg
4517F	5	5G x 1,5 - H05 VV-F	8 + 1 m	1,4 kW	4 kW	7,7 kg
5515F	5	5G x 1,5 - H07 RN-F	7 + 1 m	1,4 kW	4 kW	8,1 kg

△ The codes above are supplied without accessories: protection cap - bayonet bracket.

* Values are with cable completely unwound.

ACCESSORIES FOR ELECTRIC CABLE REELS

P/N 728115
Protection cap, in oil resistant rubber, useful to protect against accidental entry of water or foreign objects into the cable reel.



P/N 89003
Bayonet bracket, lets you easily move the cable reel within the various workstations.



EXAMPLES OF ELECTRIC CABLE REELS



P/N with protection cap



P/N with bayonet bracket



P/N with speed control and protection cap



P/N with speed control and bayonet bracket



P/N with protection cap and bayonet bracket



P/N complete



Series
280

Type
extension cord with Schuko IP44 socket and plug

Power supply
**230 V
SINGLE PHASE**

WITH SPRING



FIXED AND SWIVELLING

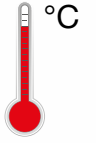

environment working
temperature -5 ÷ +40 °C



THERMAL PROTECTOR

standard

INPUT CABLE

1,2 m

COVER COLOURS

Shockproof plastic



CABLE REEL		SOCKETS AND PLUGS
Number of conductors 3	Electrical protection rating	Protection rating
<p>EN 61242 2014/35/EU 2014/30/EU 2011/65/EU</p>	<p>IP64 without cap IP65 with cap</p> <p>Warning, the system IP rating is reduced according that of the connected components.</p>	<p>IP44 Schuko sockets IP44 Schuko plugs</p>

Overall dimensions without bracket (mm)	Overall dimensions with bracket (mm)	Packaging (mm) W x D x H
		440 x 195 x 485 No. 40 packages per pallet

(W: width - D: depth - H: height)



P/N standard	Number of conductors	Type of cable	Cable length	Max. operating power (20 °C)		Weight
				Wound up	Unwound *	
2315S	3	3G x 1,5 - H05 VV-F	14 + 1 m	1,2 kW	2,3 kW	6,9 kg

⚠ The codes above are supplied without accessories: protection cap - bayonet bracket.

* Values are with cable completely unwound.

SPEED CONTROL

The versions listed below come with clutch so that cable rewinding can be performed at a controlled speed. They are marked by the **SPEED CONTROL** dataplate.



P/N with speed control	Number of conductors	Type of cable	Cable length	Max. operating power (20 °C)		Weight
				Wound up	Unwound *	
2315SF	3	3G x 1,5 - H05 VV-F	14 + 1 m	1,2 kW	2,3 kW	7,3 kg

⚠ The codes above are supplied without accessories: protection cap - bayonet bracket.

* Values are with cable completely unwound.

ACCESSORIES FOR ELECTRIC CABLE REELS

P/N 728115

Protection cap, in oil resistant rubber, useful to protect against accidental entry of water or foreign objects into the cable reel.



P/N 89003

Bayonet bracket, lets you easily move the cable reel within the various workstations.



EXAMPLES OF ELECTRIC CABLE REELS



P/N with protection cap



P/N with bayonet bracket



P/N with speed control and protection cap



P/N with speed control and bayonet bracket



P/N with protection cap and bayonet bracket



P/N complete



Series
280

Type
**extension cord with triple
Schuko IP44 socket and plug**

Power supply
**230 V
SINGLE PHASE**

WITH SPRING



**FIXED AND
SWIVELLING**

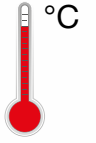

environment working
temperature -5 ÷ +40 °C



THERMAL PROTECTOR

standard

INPUT CABLE

1,2 m

COVER COLOURS

Shockproof plastic



CABLE REEL		SOCKETS AND PLUGS
Number of conductors 3	Electrical protection rating	Protection rating
<p>EN 61242 2014/35/EU 2014/30/EU 2011/65/EU</p>	<p>IP64 without cap IP65 with cap</p> <p>Warning, the system IP rating is reduced according that of the connected components.</p>	<p>IP44 Schuko sockets IP44 Schuko plugs</p>

Overall dimensions without bracket (mm)	Overall dimensions with bracket (mm)	Packaging (mm) W x D x H
		440 x 195 x 485 No. 40 packages per pallet

(W: width - D: depth - H: height)



P/N standard	Number of conductors	Type of cable	Cable length	Max. operating power (20 °C)		Weight
				Wound up	Unwound *	
2315T	3	3G x 1,5 - H05 VV-F	14 + 1 m	1,2 kW	2,3 kW	7,1 kg

⚠ The codes above are supplied without accessories: protection cap - bayonet bracket.

* Values are with cable completely unwound.

SPEED CONTROL

The versions listed below come with clutch so that cable rewinding can be performed at a controlled speed. They are marked by the **SPEED CONTROL** dataplate.



P/N with speed control	Number of conductors	Type of cable	Cable length	Max. operating power (20 °C)		Weight
				Wound up	Unwound *	
2315TF	3	3G x 1,5 - H05 VV-F	14 + 1 m	1,2 kW	2,3 kW	7,5 kg

⚠ The codes above are supplied without accessories: protection cap - bayonet bracket.

* Values are with cable completely unwound.

ACCESSORIES FOR ELECTRIC CABLE REELS

P/N 728115

Protection cap, in oil resistant rubber, useful to protect against accidental entry of water or foreign objects into the cable reel.



P/N 89003

Bayonet bracket, lets you easily move the cable reel within the various workstations.



EXAMPLES OF ELECTRIC CABLE REELS



P/N with protection cap



P/N with bayonet bracket



P/N with speed control and protection cap



P/N with speed control and bayonet bracket



P/N with protection cap and bayonet bracket



P/N complete



Series
280

Type
**without transformer
fluorescent lamp**

Power supply
**230 V AC - 50 Hz
12 V DC - 24 V DC**

WITH SPRING



**FIXED AND
SWIVELLING**

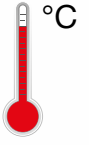

environment working
temperature -5 ÷ +40 °C



**ENERGY
SAVER**

230 V AC - 50 Hz
12 V - 24 V DC

230 V AC - 50 Hz
12 V - 24 V DC

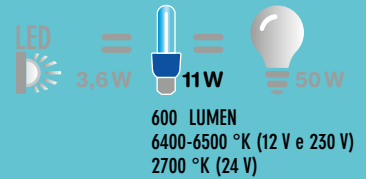

THERMAL PROTECTOR

standard

INPUT CABLE

1,2 m

COVER COLOURS

Shockproof plastic



CABLE REEL

Number of conductors 2

Electrical protection rating

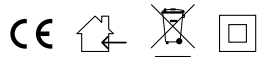

EN 61242 EN 60598
2014/35/EU 2014/30/EU
2011/65/EU UE 874/2012

IP64 without cap
IP65 with cap

Warning, the system IP rating
is reduced according that of the
connected components.

LAMP

Protection rating



IP65

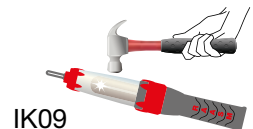

IK09

Overall dimensions without bracket (mm)

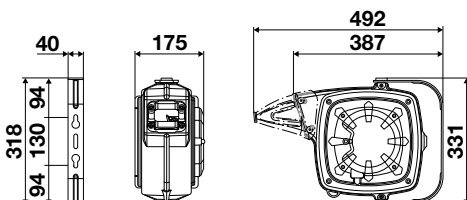

Overall dimensions with bracket (mm)

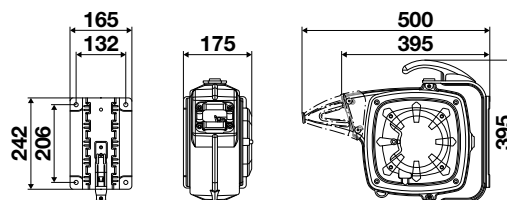

Packaging (mm) W x D x H



440 x 195 x 485



No. 40 packages
per pallet

(W: width - D: depth - H: height)



P/N standard	Number of conductors	Type of cable	Cable length	Input voltage	Lamp	Weight
2210F23	2	2 x 1 - H05 RN-F	14 + 1 m	230 V AC - 50 Hz	F230	8,0 kg
2210F12	2	2 x 1 - H05 RN-F	14 + 1 m	12 V DC	F12	8,0 kg
2210F24	2	2 x 1 - H05 RN-F	14 + 1 m	24 V DC	F24	8,0 kg

⚠ The codes above are supplied without accessories: protection cap - bayonet bracket.

SPEED CONTROL

The versions listed below come with clutch so that cable rewinding can be performed at a controlled speed. They are marked by the **SPEED CONTROL** dataplate.



P/N with speed control	Number of conductors	Type of cable	Cable length	Input voltage	Lamp	Weight
2210F23F	2	2 x 1 - H05 RN-F	14 + 1 m	230 V AC - 50 Hz	F230	8,4 kg
2210F12F	2	2 x 1 - H05 RN-F	14 + 1 m	12 V DC	F12	8,4 kg
2210F24F	2	2 x 1 - H05 RN-F	14 + 1 m	24 V DC	F24	8,4 kg

⚠ The codes above are supplied without accessories: protection cap - bayonet bracket.

ACCESSORIES FOR ELECTRIC CABLE REELS

P/N 728115

Protection cap, in oil resistant rubber, useful to protect against accidental entry of water or foreign objects into the cable reel.



P/N 89003

Bayonet bracket, lets you easily move the cable reel within the various workstations.



EXAMPLES OF ELECTRIC CABLE REELS



P/N with protection cap

P/N with bayonet bracket

P/N with speed control and protection cap

P/N with speed control and bayonet bracket

P/N with protection cap and bayonet bracket

P/N complete



Series
280

Type
**without transformer
LED lamp**

Power supply
12 ÷ 24 V AC/DC

WITH SPRING



**FIXED AND
SWIVELLING**

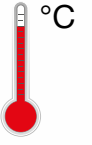

environment working
temperature -5 ÷ +40 °C



**ENERGY
SAVER**

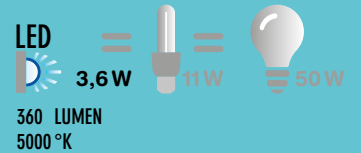

THERMAL PROTECTOR

standard

INPUT CABLE

1,2 m

COVER COLOURS

Shockproof plastic



CABLE REEL

Number of conductors 2

Electrical protection rating

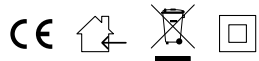

IP64 without cap
IP65 with cap

EN 61242 EN 60598
2014/35/EU 2014/30/EU
2011/65/EU EU 874/2012

Warning, the system IP rating
is reduced according that of the
connected components.

LAMP

Protection rating

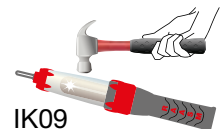

Overall dimensions without bracket (mm)

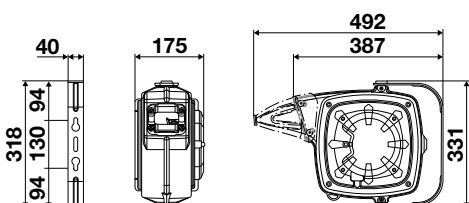

Overall dimensions with bracket (mm)

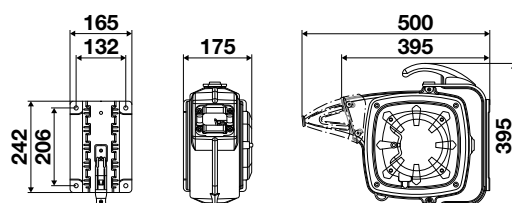

Packaging (mm) W x D x H





P/N standard	Number of conductors	Type of cable	Cable length	Input voltage	Lamp	Weight
2210L	3	3G x 1,5 - H05 VV-F	14 + 1 m	12 ÷ 24 V AC/DC	L1224	7,1 kg

⚠ The codes above are supplied without accessories: protection cap - bayonet bracket.

SPEED CONTROL

The versions listed below come with clutch so that cable rewinding can be performed at a controlled speed. They are marked by the **SPEED CONTROL** dataplate.



P/N with speed control	Number of conductors	Type of cable	Cable length	Input voltage	Lamp	Weight
2210LF	3	3G x 1,5 - H05 VV-F	14 + 1 m	12 ÷ 24 V AC/DC	L1224	7,5 kg

⚠ The codes above are supplied without accessories: protection cap - bayonet bracket.

ACCESSORIES FOR ELECTRIC CABLE REELS

P/N 728115
Protection cap, in oil resistant rubber, useful to protect against accidental entry of water or foreign objects into the cable reel.



P/N 89003
Bayonet bracket, lets you easily move the cable reel within the various workstations.



EXAMPLES OF ELECTRIC CABLE REELS



P/N with protection cap

P/N with bayonet bracket

P/N with speed control and protection cap

P/N with speed control and bayonet bracket

P/N with protection cap and bayonet bracket

P/N complete



Series
290

Type
**with transformer
with LED lamp**

Power supply
**230 V
SINGLE PHASE**

WITH SPRING



**FIXED AND
SWIVELLING**

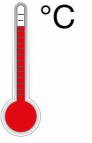

environment working
temperature -5 ÷ +40 °C



12 ÷ 24 V AC/DC

230 V AC - 50 Hz



**ENERGY
SAVER**

LED 3,6 W = 11 W = 50 W
360 LUMEN
5000 °K

THERMAL PROTECTOR

standard

INPUT CABLE

1,2 m

COVER COLOURS

Shockproof plastic



CABLE REEL

Number of conductors 2



EN 61242 EN 60598
EN 62471

2014/35/EU 2014/30/EU
2011/65/EU UE.874/2012

Electrical protection rating

IP64 without cap
IP65 with cap

Warning, the system IP rating
is reduced according that of the
connected components.

LAMP

Protection rating



IP65



IK09

Overall dimensions without bracket (mm)

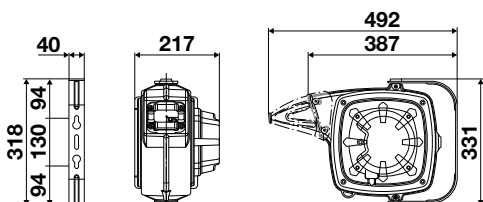

Overall dimensions with bracket (mm)

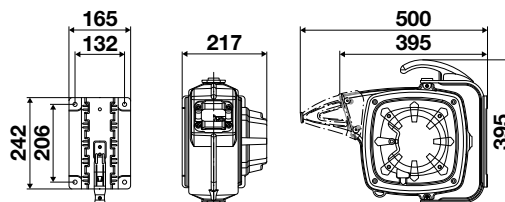

Packaging (mm) W x D x H

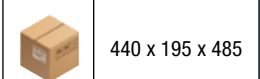

440 x 195 x 485



No. 40 packages
per pallet

(W: width - D: depth - H: height)



P/N standard	Number of conductors	Type of cable	Cable length	Input voltage	Lamp	Weight
2210TL	2	2 x 1 - H05 RN-F	14 + 1 m	230 V AC - 50 Hz	L1224	9,0 kg

⚠ The codes above are supplied without accessories: protection cap - bayonet bracket.

SPEED CONTROL

The versions listed below come with clutch so that cable rewinding can be performed at a controlled speed. They are marked by the **SPEED CONTROL** dataplate.



P/N with speed control	Number of conductors	Type of cable	Cable length	Input voltage	Lamp	Weight
2210TLF	2	2 x 1 - H05 RN-F	14 + 1 m	230 V AC - 50 Hz	L1224	9,4 kg

⚠ The codes above are supplied without accessories: protection cap - bayonet bracket.

ACCESSORIES FOR ELECTRIC CABLE REELS

P/N 728115

Protection cap, in oil resistant rubber, useful to protect against accidental entry of water or foreign objects into the cable reel.



P/N 89003

Bayonet bracket, lets you easily move the cable reel within the various workstations.



EXAMPLES OF ELECTRIC CABLE REELS



P/N with protection cap



P/N with bayonet bracket



P/N with speed control and protection cap



P/N with speed control and bayonet bracket



P/N with protection cap and bayonet bracket



P/N complete



Series
F12 - F24
F230 - L1224

Type
Fluorescent
and LED lamp

Power supply
12 ÷ 24 V AC/DC
230 V AC - 50 Hz

WITH SPRING



- MAGNETIC SUPPORT
- REPLACEABLE, TRANSPARENT PROTECTION COVER
- ANTI-SKIDDING GRIP
- PROTECTION FUSE - 2 A
- ADJUSTABLE HOOK
- PROTECTED SWITCH

Series F12 - F24	Series F230	Series L1224
EN 60598-1 EN 60598-2-8	EN 60598-1 EN 60598-2-8	EN 60598-1 EN 60598-2-8 CEI.EN.62471
2014/35/EU 2014/30/EU 2011/65/EU EU 874/2012	2014/35/EU 2014/30/EU 2011/65/EU EU 874/2012	2014/35/EU 2014/30/EU 2011/65/EU EU 874/2012

Protection rating	Overall dimensions (mm)	Packaging (mm) W x D x H	
<p>IP 65</p>			525 x 135 x 80
<p>IK 09</p>			<p>No. 40 packages per pallet</p>

(W: width - D: depth - H: height)





PORTABLE FLUORESCENT LAMP series F12 - F24 - F230

Lamp code	Power supply voltage	Lamp connection	Max. power	Lamp protection rating	Bulb supplied	Weight
F12	12 V DC	E27	11 W	IP65	P/N 728002	0,6 kg
F24	24 V DC	E27	11 W	IP65	P/N 728003	0,6 kg
F230	230 V AC - 50 Hz	E27	11 W	IP65	P/N 728001	0,6 kg

⚠ The codes above refer to the lamp supplied without cable.

⚠ All models shown can be supplied with energy efficiency class B, A and A + bulbs as per EU regulation 874/2012. Fluorescent bulbs can be replaced as long as the same energy efficiency class is used.

 =  = 
 3,6W 11W 50W
 600 LUMEN
 6400-6500 °K (12 V e 230 V)
 2700 °K (24 V)

P/N 728002 Bulb 11 W 12 V DC
P/N 728003 Bulb 11 W 24 V DC
P/N 728001 Bulb 11 W 230 V AC - 50 Hz



⚠

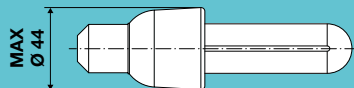

Power the cable reel only with the correct voltage for the lamp. Use with any other voltage will irreparably damage the lamp, and will void any warranty.



PORTABLE LED LAMP series L1224

Lamp code	Power supply voltage	No. of LEDs	LED power module	Lamp protection rating	LED module	Weight
L1224	12 ÷ 24 V AC/DC	12	3,6 W	IP65	P/N 728005	0,6 kg

⚠ All models shown can be supplied with energy efficiency class B, A and A + bulbs as per EU regulation 874/2012.

 =  = 
 3,6W 11W 50W
 360 LUMEN
 5000 °K

P/N 728005
 LED module, consisting of 12 LEDs, 0.3 W each. The LED modules cannot be replaced with others available on the market.



⚠

Power the cable reel only with the correct voltage for the lamp. Use with any other voltage will irreparably damage the lamp, and will void any warranty.





Series
280

Type
EARTHING

WITH SPRING



FIXED AND SWIVELLING

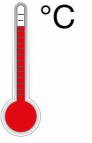

environment working
temperature -5 ÷ +40 °C

INPUT CABLE

1,2 m

COVER COLOURS

Shockproof plastic



CABLE REEL	
Number of conductors 1	Electrical protection rating
CE EN 61242 2014/35/EU 2014/30/EU 2011/65/EU	IP64 without cap IP65 with cap Warning, the system IP rating is reduced according that of the connected components.

Overall dimensions without bracket (mm)	Overall dimensions with bracket (mm)	Packaging (mm) W x D x H
		440 x 195 x 485 No. 40 packages per pallet

(W: width - D: depth - H: height)



P/N standard	Number of conductors	Type of cable	Cable length	Earthing clamp		Weight
				P/N	Ampere	
1065	1	1 x 6 - H07 V-K	15 + 1 m	-	-	6,7 kg
1161	1	1 x 16 - H07 V-K	10 + 1 m	-	-	5,0 kg
1065P	1	1 x 6 - H07 V-K	15 + 1 m	735112	50	6,8 kg
1161P	1	1 x 16 - H07 V-K	10 + 1 m	735111	100	7,5 kg
1064P	1	1 x 6 - PUR	14,5 m	explosion-proof	10	9,0 kg

△ The codes above are supplied without accessories: protection cap - bayonet bracket.

SPEED CONTROL

The versions listed below come with clutch so that cable rewinding can be performed at a controlled speed. They are marked by the **SPEED CONTROL** dataplate.



P/N with speed control	Number of conductors	Type of cable	Cable length	Earthing clamp		Weight
				P/N	Ampere	
1065F	1	1 x 6 - H07 V-K	15 + 1 m	-	-	7,1 kg
1161F	1	1 x 16 - H07 V-K	10 + 1 m	-	-	5,4 kg
1065PF	1	1 x 6 - H07 V-K	15 + 1 m	735112	50	7,2 kg
1161PF	1	1 x 16 - H07 V-K	10 + 1 m	735111	100	7,9 kg
1064PF	1	1 x 6 - PUR	14,5 m	explosion-proof	10	9,4 kg

△ The codes above are supplied without accessories: protection cap - bayonet bracket.

ACCESSORIES FOR ELECTRIC CABLE REELS

P/N 728115
Protection cap, in oil resistant rubber, useful to protect against accidental entry of water or foreign objects into the cable reel.



P/N 89003
Bayonet bracket, lets you easily move the cable reel within the various workstations.



EXAMPLES OF ELECTRIC CABLE REELS



P/N with protection cap



P/N with bayonet bracket



P/N with speed control and protection cap



P/N with speed control and bayonet bracket



P/N with protection cap and bayonet bracket



P/N complete



Series
350

Type
EARTHING

WITH SPRING

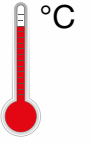

environment working
temperature -5 ÷ +40 °C



In accordance with directive



Overall dimensions (mm)		Packaging (mm) W x D x H	
			390 x 188 x 403
			No. 36 packages per pallet

COVER COLOURS

Shockproof plastic



P/N standard	Type of cable	Cable conductor material	Cable conductor insulation	Cable length (m)	Earthing clamp		Weight
					P/N	Ampere	
735000	without cable	cable capacity max. 30 m - section 16 mm ²			-	-	12,3 kg
735131.60141	1 x 6	copper (green-yellow cable)	PUR	14,5 m	explosion-proof	10	14,1 kg
735131.60261	1 x 6	copper (green-yellow cable)	PUR	26 m	explosion-proof	10	22,3 kg
735131.60152	1 x 6	copper (green-yellow cable)	PUR	15 m	735112	50	13,6 kg
735131.60252	1 x 6	copper (green-yellow cable)	PUR	25 m	735112	50	14,7 kg
735141.60152	1 x 7	steel (orange cable)	PVC	15 m	735112	50	13,2 kg
735141.60252	1 x 7	steel (orange cable)	PVC	25 m	735112	50	14,0 kg



TECHNICAL CHARACTERISTICS

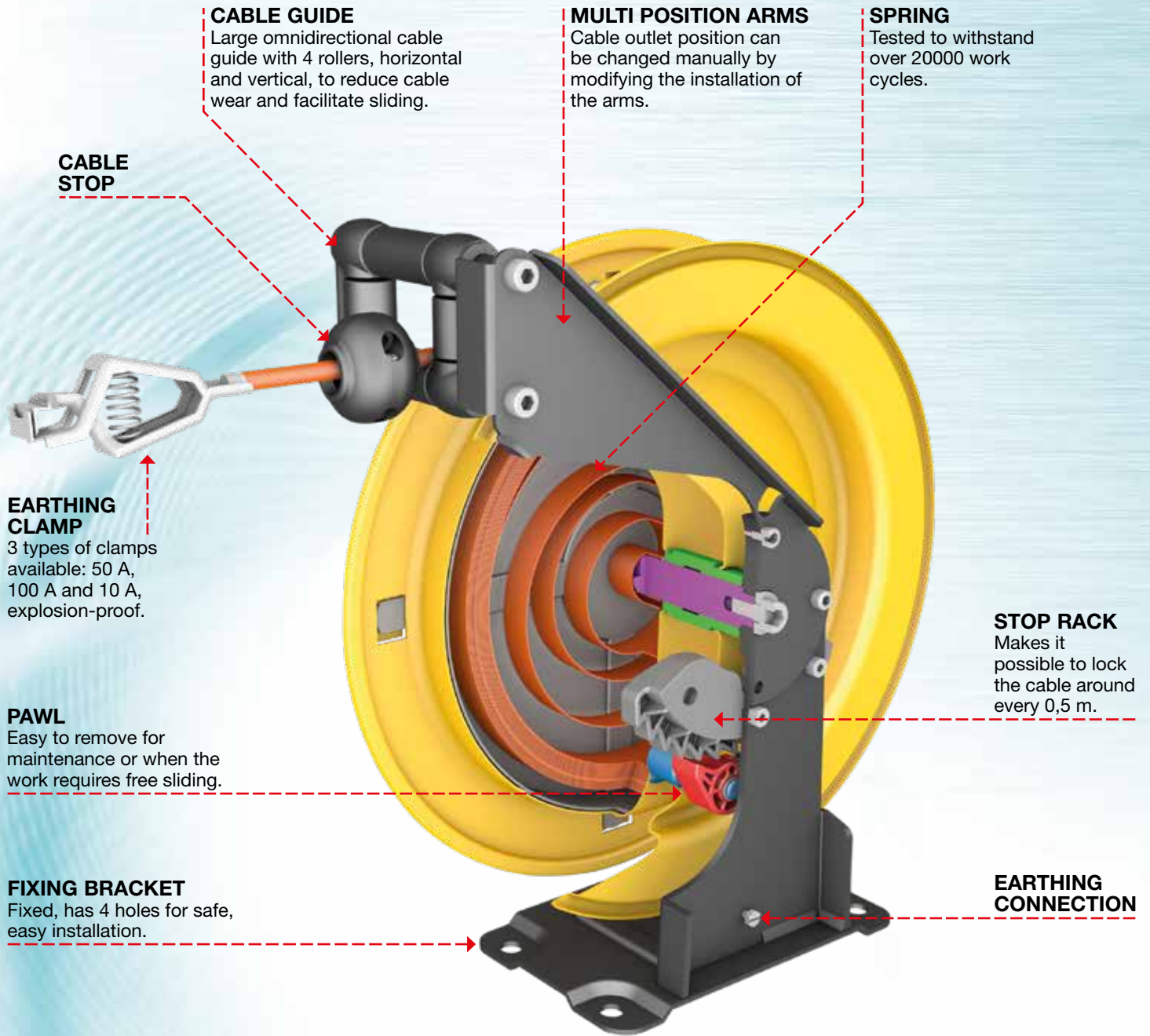

CABLE GUIDE
Large omnidirectional cable guide with 4 rollers, horizontal and vertical, to reduce cable wear and facilitate sliding.

MULTI POSITION ARMS
Cable outlet position can be changed manually by modifying the installation of the arms.

SPRING
Tested to withstand over 20000 work cycles.

CABLE STOP

EARTHING CLAMP
3 types of clamps available: 50 A, 100 A and 10 A, explosion-proof.

PAWL
Easy to remove for maintenance or when the work requires free sliding.

FIXING BRACKET
Fixed, has 4 holes for safe, easy installation.

STOP RACK
Makes it possible to lock the cable around every 0,5 m.

EARTHING CONNECTION

ACCESSORIES FOR EARTHING CABLE REELS

P/N 735111
Earthing clamp 100 A.



P/N 735112
Earthing clamp 50 A.



EXPLOSION-PROOF earthing clamp 10 A with cable measuring from 14,5 m or from 26 m. For information, contact our offices.



ARTICLES INDEX

P/N	page	P/N	page	P/N	page	P/N	page	P/N	page
1064P	167	256535.200	119		151-153	753004	120	7562001.450	101
1064PF	167	256535.300	119	728115	155-157	75320.100	95	75640.200	99-103
1065	167	256535.350	119		159-161	75320.150	95-111	75640.206	99-103
1065F	167	256545.200	119	735000	168	75320.500	107	75640.300	99
1065P	167	256545.205	119	735111	169	7532001.100	93-109	75640.350	99
1065PF	167	256545.300	119	735112	169	7532001.150	93	756401	120
1161	167	256545.350	119	735131.60141	168	7532001.200	97	75650.200	99
1161F	167	256565.200	119	735131.60152	168	7532001.250	97	75650.206	99
1161P	167	256565.205	119	735131.60252	168	7532001.300	97	756501	120
1161PF	167	256565.300	119	735131.60261	168	7532001.400	101	77/12775	121-138
2210	151	256565.350	119	735141.60152	168	7532001.450	101	77/12775B	121-138
2210F	151	3210	151	735141.60252	168	75340.200	99-103	77/14175	121-138
2210F12	159	3210F	151	74300.100	93	75340.300	99	77/14175B	121-138
2210F12F	159	3310	151	74300.200	97	75340.350	99	77/15575	121-138
2210F23	159	3310F	151	74300.250	97	753401	120	77/15575B	121-138
2210F23F	159	33114	145	74300.300	97	753404	120	77/16975	121-138
2210F24	159	33116	145	74300.350	97	75350.200	99	77/16975B	121-138
2210F24F	159	33117	145	74300.400	101	75350.300	99	77/22775	121-138
2210L	161	33118	145	74300.450	101	75350.350	99	77/22775B	121-138
2210LF	161	33119	145	74300.500	105	753501	120	77/24175	121-138
2210TL	163	33128	145	74300.600	109	753504	120	77/24175B	121-138
2210TLF	163	33129	145	743001	120	75400.100	93-109	77/25575	121-138
2215	151	33130	145	743004	120	75400.105	93	77/25575B	121-138
2215F	151	33131	145	74301	120	75400.200	97	77/26975	121-138
2225	151	33132	145	74302	120	75400.205	97	77/26975B	121-138
2225F	151	33133	145	74305.100	93	75400.300	97	77/2F	121-138
2310	151	3315	151	74305.200	97	75400.350	97	77/32775	121-138
2310F	151	3315F	151	74305.300	97	75400.400	101	77/32775B	121-138
2315	151	3325	151	74305.350	97	75400.405	101	77/34175	121-138
2315F	151	3325F	151	74305.400	101	75400.500	105	77/34175B	121-138
2315S	155	33270	145	74305.500	105	754001	120	77/35575	121-138
2315SF	155	33271	145	74305.600	109	75420.100	95-111	77/35575B	121-138
2315T	157	33272	145	74320.100	95	75420.105	95	77/36975	121-138
2315TF	157	33273	145	74320.150	95	75420.500	107	77/36975B	121-138
2325	151	33274	145	74320.500	107	75440.200	99-103	77/3F	121-138
2325F	151	38071	145	74320.600	111	75440.205	99-103	77/44312	78
236530.100	117	38072	145	74325.100	95	75440.300	99	77/45312	78
236530.200	117	38073	145	74325.500	107	75440.350	99	77/45401	78
236530.300	117	38074	145	74325.600	111	754401	120	77/45412	78
236530.350	117	38120	145	74340.200	99-103	75450.200	99	77/45601	78
236540.100	117	38121	145	74340.250	99	75450.205	99	77/45612	78
236540.105	117	38122	145	74340.300	99	754501	120	77/4F	121-138
236540.200	117	38123	145	74340.350	99	7552001.100	93-109	7721001.100	93-109
236540.205	117	38124	145	743401	120	7552001.150	93	7721001.400	101
236540.300	117	38125	145	743404	120	7552001.200	97	7721301.100	127-137
236540.350	117	4410	153	74345.200	99-103	7552001.250	97	7721301.400	133
236560.100	117	4410F	153	74345.300	99	7552001.300	97	7721601.100	127-137
236560.105	117	4415	153	74345.350	99	7552001.400	101	7721601.400	133
236560.200	117	4415F	153	74350.200	99	7552001.450	101	7721702.100	127-137
236560.205	117	4425	153	74350.300	99	75600.100	93-109	7721702.400	133
236560.300	117	4425F	153	74350.350	99	75600.106	93	7721801.100	127-137
236560.350	117	4510	153	743501	120	75600.200	97	7721801.400	133
246532.100	119	4510F	153	743504	120	75600.206	97	7721901.100	127-137
246534.200	119	4517	153	7522001.100	93-109	75600.300	97	7721901.400	133
246534.300	119	4517F	153	7522001.150	93	75600.350	97	7724001.200	99
246534.350	119	5415	153	7522001.200	97	75600.400	101	7724301.200	131
246542.100	119	5415F	153	7522001.250	97	75600.406	101	7724601.200	131
246542.105	119	5425	153	7522001.300	97	75600.500	105	7724702.200	131
246544.200	119	5425F	153	7522001.400	101	756001	120	7724801.200	131
246544.205	119	5515	153	7522001.450	101	75620.100	95-111	7724901.200	131
246544.300	119	5515F	153	75300.100	93	75620.106	95	7725001.200	99
246544.350	119	66891	145	75300.150	93-109	75620.500	107	7725301.200	131
246562.100	119	66892	145	75300.200	97	7562001.100	93-109	7725601.200	131
246562.105	119	66893	145	75300.300	97	7562001.150	93	7725702.200	131
246564.200	119	728001	165	75300.350	97	7562001.200	97	7725801.200	131
246564.205	119	728002	165	75300.400	101	7562001.250	97	7725901.200	131
246564.300	119	728003	165	75300.500	105	7562001.300	97	7726601.200	129
246564.350	119	728005	165	753001	120	7562001.400	101	7726702.200	129

P/N	page
7741001.100	93-109
7741001.400	101
7741301.100	127-137
7741301.400	133
7741601.100	127-137
7741601.400	133
7741702.100	127-137
7741702.400	133
7741801.100	127-137
7741801.400	133
7741901.100	127-137
7741901.400	133
7744001.200	99
7744301.200	131
7744601.200	131
7744702.200	131
7744801.200	131
7744901.200	131
7745001.200	99
7745301.200	131
7745601.200	131
7745702.200	131
7745801.200	131
7745901.200	131
7746601.200	129
7746901.200	129
7751001.100	93-109
7751001.400	101
7751301.100	127-137
7751301.400	133
7751601.100	127-137
7751601.400	133
7751702.100	127-137
7751702.400	133
7751801.100	127-137
7751801.400	133
7751901.100	127-137
7751901.400	133
7754301.200	131
7754601.200	131
7754702.200	131
7754801.200	131
7754901.200	131
7755001.200	99
7755301.200	131
7755601.200	131
7755702.200	131
7755801.200	131
7755901.200	131
7756601.200	129
7756702.200	129
7771001.100	93-109
7771001.400	101
7771301.100	127-137
7771301.400	133
7771601.100	127-137
7771601.400	133
7771702.100	127-137
7771702.400	133
7771801.100	127-137
7771801.400	133
7771901.100	127-137
7771901.400	133
7774001.200	99
7774301.200	131
7774601.200	131
7774702.200	131
7774801.200	131

P/N	page
7774901.200	131
7775001.200	99
7775301.200	131
7775601.200	131
7775702.200	131
7775801.200	131
7775901.200	131
79/44312	79
79/45312	79
79/45401	79
79/45412	79
79/45601	79
79/45601	79
79/45612	79
8288.100	67
8288.102	67
8288.103	67
8288.104	67
8288.105	67
8290.100	19
8290.101	19
8290.104	19
8292.100	21
8292.101	21
8292.104	21
8328.100	67
8328.102	67
8328.103	67
8328.104	67
8328.105	67
8330.100	19
8330.101	19
8330.200	23
8330.201	23
8330.300	27
8330.301	27
8330.350	31
8330.400	37
8330.402	37
8330.500	41
8330.501	41
8330.800	51
8330.801	51
8330.802	51
8332.100	21
8332.101	21
8332.201	25
8332.300	29
8332.301	29
8332.350	33
8332.400	25
8333.101	21
8333.202	25
8333.301	29
8378.100	67
8378.102	67
8378.103	67
8378.104	67
8378.105	67
8380.100	19
8380.102	19
8380.200	23
8380.202	23
8380.300	27
8380.302	27
8380.350	31
8380.352	31
8380.400	37

P/N	page
8380.401	37
8380.402	37
8380.500	41
8380.501	41
8380.502	41
8382.100	21
8382.102	21
8382.200	25-39
8382.202	25
8382.300	29
8382.302	29
8382.350	33
8382.352	33
8382.500	43
8383.201	25
8383.301	29
8390.100	19
8390.102	19
8390.200	23
8390.202	23
8390.300	27
8390.302	27
8390.350	31
8390.352	31
8390.400	37
8390.401	37
8390.402	37
8390.500	41
8390.501	41
8390.502	41
8390.800	51
8390.801	51
8390.802	51
8392.100	21
8392.102	21
8392.200	25-39
8392.202	25
8392.300	29
8392.302	29
8392.350	33
8392.352	33
8392.500	43
8393.201	25
8393.301	29
8420.100	19
8420.101	19
8420.102	19
8420.103	19
8420.104	19
8420.200	23
8420.201	23
8420.202	23
8420.300	27
8420.301	27
8420.302	27
8420.350	31
8420.354	31
8420.400	37
8420.401	37
8420.401/AS	37
8420.402	37
8420.500	41
8420.501	41
8420.502	41
8420.502	41
8420.505	41
8420.506	41
8422.100	21
8422.101	21

P/N	page
8422.102	21
8422.103	21
8422.104	21
8422.201	25
8422.202	25
8422.301	29
8422.302	29
8422.354	33
8422.500	43
8423.202	25
8423.302	29
8423.354	33
8424.200	25-39
8424.300	29
8424.350	33
8430.100	19-67
8430.1000	55
8430.101	19
8430.102	19
8430.103	19
8430.104	19
8430.150	19-45
8430.200	23
8430.201	23
8430.202	23
8430.250	23
8430.300	27
8430.3000	55
8430.301	27
8430.302	27
8430.350	31
8430.354	31
8430.400	37
8430.400/AS	37
8430.4000	55
8430.401	37
8430.401/AS	37
8430.402	37
8430.415	37
8430.415/AS	37
8430.416	37
8430.417	37
8430.450	37
8430.452/AS	37
8430.500	41
8430.5000	55
8430.501	41
8430.502	41
8430.505	41
8430.506	41
8430.5500	55
8430.600	45
8430.601	45
8430.602	45
8430.700	53
8430.701	53
8430.702	53
8430.800	51
8430.802	51
8430.804	51
843001	80-120
843002	80-120
843005	81
843006	81
843011	82
843012	82
843013	82
8432.100	21

P/N	page
8432.101	21
8432.102	21
8432.103	21
8432.104	21
8432.150	21
8432.201	25
8432.202	25
8432.301	29
8432.302	29
8432.354	33
8432.500	43
8433.102	21
8433.202	25
8433.302	29
8433.354	33
8434.200	25-39-49
8434.250	25-39-49
8434.300	29
8434.350	33
8435.200	35
8435.300	35
8435.350	35
8436.200	49
8436.250	49
8436.251	49
8436.252	49
8438.101	67
8438.102	67
8440.100	61
8440.101	61
8440.102	61
8440.103	61
8440.104	61
8440.400	61
8440.401	61
8440.401/AS	61
8440.402	61
8440.500	61
8440.501	61
8440.502	61
8440.505	61
8440.506	61
8450.100	61
8450.101	61
8450.102	61
8450.104	61
8450.400	61
8450.401	61
8450.401/AS	61
8450.402	61
8450.500	61
8450.501	61
8450.502	61
8450.505	61
8450.506	61
845001	80
845005	81
8520.100	19
8520.101	19
8520.102	19
8520.200	23
8520.201	23
8520.300	27
8520.301	27
8520.302	27
8520.350	31
8520.352	31

ARTICLES INDEX

P/N	page	P/N	page	P/N	page	P/N	page	P/N	page
8520.400	37	8533.102	21	8542.602	47	8562.101	21	92858.105	71
8520.401	37	8533.202	25	8542.603	47	8562.103	21	93108.102	75
8520.402	37	8533.302	29	8543.102	21	8562.104	21	93108.103	75
8520.500	41	8533.352	33	8543.103	21	8562.105	21	93108.104	75
8520.501	41	8534.200	25-39	8543.106	21	8562.106	21	93108.105	75
8520.502	41	8534.250	25-39-49	8543.202	25	8562.205	25	93108.106	75
8522.100	21	8534.300	29	8543.301	29	8562.301	29	93208.102	75
8522.101	21	8534.350	33	8544.200	25-39	8562.302	29	93208.103	75
8522.102	21	8534.550	33	8544.205	25-39	8562.603	47	93208.104	75
8522.201	25	8535.200	35	8544.300	29	8562.604	47	93208.105	75
8522.301	29	8535.300	35	8544.350	33	8562.605	47	93208.106	75
8522.302	29	8535.350	35	8544.550	33	8563.103	21	9430.100	19
8522.352	33	8537.200	49	8545.200	35	8563.105	21	9430.101	19
8522.500	43	8537.251	49	8545.205	35	8564.200	25	9430.102	19
8523.202	25	8537.252	49	8550.100	19	8564.206	25	9430.103	19
8523.302	29	8540.100	19-45	8550.101	19	8564.300	29	9430.104	19
8523.352	33	8540.1000	55	8550.102	19	8564.350	33	9430.200	23
8524.200	25-39	8540.101	19	8550.103	19	8565.200	35	9430.201	23
8524.300	29	8540.102	19	8550.105	19	8565.206	35	9430.202	23
8524.350	33	8540.103	19	8550.106	19	8617.100	127	9430.300	27
8530.100	19	8540.105	19	8550.200	23	8617.200	129	9430.301	27
8530.1000	55	8540.106	19	8550.202	23	8617.400	133	9430.302	27
8530.101	19	8540.200	23	8550.203	23	8617.500	135	9430.400	37
8530.102	19	8540.202	23	8550.300	27	8617.600	137	9430.400/AS	37
8530.150	19-45	8540.203	23	8550.301	27	8618.100	127-137	9430.401	37
8530.200	23	8540.300	27	8550.350	31	8618.200	129	9430.402	37
8530.201	23	8540.3000	55	8550.400	37	8618.400	133	9430.415	37
8530.300	27	8540.301	27	8550.405	37	8618.500	135	9430.416	37
8530.3000	55	8540.350	31	8550.406	37	8637.100	127	9430.417	37
8530.301	27	8540.400	37	8550.411	37	8637.200	129	9430.500	41
8530.302	27	8540.4000	55	8550.412	37	8637.400	133	9430.501	41
8530.350	31	8540.405	37	8550.413	37	8637.500	135	9430.502	41
8530.352	31	8540.406	37	8550.500	41	8637.600	137	9430.505	41
8530.400	37	8540.411	37	8550.501	41	8638.100	127-137	9430.506	41
8530.4000	55	8540.412	37	8552.100	21	8638.200	129	9430.600	45
8530.401	37	8540.413	37	8552.101	21	8638.400	133	9430.601	45
8530.402	37	8540.414	37	8552.102	21	8638.500	135	9430.602	45
8530.415	37	8540.500	41	8552.103	21	88630	83	9431.202	23
8530.416	37	8540.5000	55	8552.105	21	88650	83-120	9431.302	27
8530.500	41	8540.501	41	8552.106	21	88651	83-120	9432.100	21
8530.5000	55	8540.5500	55	8552.202	25	89001	83	9432.101	21
8530.501	41	8540.601	45	8552.203	25	89002	83	9432.102	21
8530.502	41	8540.602	45	8552.301	29		83	9432.103	21
8530.5500	55	8540.603	45	8553.202	25	89003	151-153 155-157 159-161 163-167	9432.104	21
8530.603	45	8540.700	53	8553.301	29			9432.201	25
8530.604	45	8540.701	53	8554.200	25-39	89005	83	9432.202	25
8530.700	53	8540.702	53	8554.205	25-39	89010	71	9432.301	29
8530.701	53	8540.704	53	8554.300	29	89011	71	9432.302	29
8530.702	53	8540.705	53	8554.350	33	89109	71	9432.353	33
8530.703	53	8540.707	53	8560.100	19-45	89110	71	9432.354	33
8530.704	53	8540.709	53	8560.101	19	92438.101	67	9432.401	39
8530.705	53	8540.800	51	8560.103	19	92438.102	67	9432.402	39
8530.800	51	8540.802	51	8560.104	19	92608.101	75	9432.500	43
8530.802	51	854001	80-120	8560.105	19	92608.102	75	9432.501	43
8530.804	51	854002	80-120	8560.106	19	92708.101	75	9432.502	43
853001	80-120	854005	81	8560.200	23	92708.102	75	9432.505	43
853002	80-120	854006	81	8560.205	23	92808.101	71	9432.506	43
853005	81	854007	81	8560.300	27	92808.102	71	9433.102	21
853006	81	8542.100	21-47	8560.301	27	92808.105	71	9433.202	25
8532.100	21	8542.101	21	8560.302	27	92818.101	71	9433.302	29
8532.101	21	8542.102	21	8560.350	31	92818.102	71	9434.200	25-39
8532.102	21	8542.103	21	8560.400	37	92818.105	71	9434.300	29
8532.150	21-47	8542.105	21	8560.603	45	92848.101	71	9434.350	33
8532.201	25	8542.106	21	8560.604	45	92848.102	71	9436.200	49
8532.301	29	8542.202	25	8560.605	45	92848.105	71	9436.201	49
8532.302	29	8542.203	25	856001	80-120	92848.105	71	9437.200	49
8532.352	33	8542.301	29	856002	80-120	92858.101	71	9437.201	49
8532.500	43	8542.601	47	8562.100	21-47	92858.102	71	9450.100	61

P/N	page
9450.101	61
9450.102	61
9450.103	61
9450.104	61
9450.400	61
9450.401	61
9450.402	61
9450.500	61
9450.501	61
9450.502	61
9450.505	61
9450.506	61
971.010	141
971.011	141
971.015	141
971.102	140
971.111	141
971.115	141
971.118	141
971.120	141
972.102	140
972.113	141
972.115	141
972.120	141
973.913	144
973.917	144
973.920	144
973.925	144
973.930	144
974.1008	144
974.1015	144
974.1020	144
974.1028	144
974.912	144
974.915	144
974.920	144
974.925	144
974.930	144
975.1002	140

P/N	page
975.1010	144
975.1015	144
975.1018	144
975.1027	144
975.1030	144
975.902	140
975.915	144
975.920	144
975.927	144
976.102	140
976.108	141
976.110	141
976.111	141
976.112	141
976.114	141
976.115	141
987.205	140
987.206	140
987.208	144
987.210	144
987.215	144
993.201	140
993.202	140
993.215	141
993.504	140
993.511	143
993.512	143
993.516	143
993.518	143
994.512	142
994.517	142
994.612	142
994.717	142
995.106	140
995.112	141
995.206	140
995.210	141
995.211	141
995.212	141

P/N	page
995.217	141
995.218	141
995.301	140
995.312	143
995.313	142
995.317	143
995.318	142
995.412	142
995.506	140
995.512	142
995.518	142
995.520	142
995.525	142
995.530	142
995.540	142
995.550	142
995.606	140
995.618	142
995.625	142
995.630	142
995.701	140
995.702	140
995.706	140
995.710	143
995.715	143
995.720	143
995.725	143
995.730	143
995.806	140
995.815	142
995.820	142
995.825	142
995.906	140
995.915	142
995.925	142
996.106	140
996.110	141
996.116	141
996.120	141

P/N	page
996.125	141
996.130	141
996.210	141
996.215	141
996.220	141
996.225	141
996.230	141
996.301	140
996.3015	140
996.302	140
996.304	140
996.305	140
996.306	140
996.310	143
996.311	142
996.315	143
996.316	142
996.320	143
996.321	142
996.325	143
996.330	143
996.406	140
996.415	142
996.425	142
997.115	141
997.120	141
997.130	141
997.140	141
997.215	141
997.220	141
997.230	141
997.240	141
997.320	142
997.3305	140
997.3306	140
997.3308	143
997.3312	143
997.3315	143
997.3320	143

P/N	page
997.3330	143
997.3340	143
997.420	142
997.806	140
997.808	143
997.812	143
997.815	143
997.820	143
997.840	143
998.106	140
998.115	141
998.120	141
998.130	141
998.215	141
998.220	141
998.230	141
998.305	140
998.315	141
998.330	141
998.3301	140
998.3302	140
998.3306	140
998.3310	142
998.3315	142
998.3320	142
998.3330	142
998.406	140
998.806	140
998.808	143
998.815	143
998.820	143
998.830	143
999.3310	143
999.810	143
F12	165
F230	165
F24	165
L1224	165

GENERAL SALES CONDITIONS

FOR FOREIGN MARKETS



The following general sales conditions regulate the sale of goods and services by the company RAASM S.p.A. for customers residing outside the territory of the Italian State.

Art. 1 GOODS DELIVERY TERMS

The goods are delivered ex works RAASM S.p.A. The subsequent transport/shipment must occur by, in the name and at the expense of the purchasing customer, even by means of a carrier appointed and designated by the same. All risks arising from loading, subsequent custody and transport are borne entirely by the purchasing customer.

Art. 2 MINIMUM ORDERS

Each order cannot be for less than € 1,500.00, net of fees, taxes, customs duties, discounts and rebates and any other charges not included in the price of the goods. If, at the option of RAASM S.p.A., orders for lower amounts are accepted, an extra charge of € 155,00 shall be applied for order management administrative expenses.

Art. 3 ACCESSORIES

All the accessories given in the price list (plugs, oil bar taps, oil guns, grease guns, probes, protection caps, clutches, swivelling supports, etc.) are supplied exclusively for fitting to or combining with the items RAASM S.p.A. produces

Art. 4 COMPLAINTS

Any defects immediately noticed after a brief inspection of the goods (damage, shortages or different product from that ordered) must be notified in writing to our company within 8 (eight) days of receipt the goods. Any defects in the product noticeable only during its use must be notified in writing to RAASM S.p.A. within 8 (eight) days of being detected. Any returns of goods must be authorized in advance by RAASM S.p.A. and freight charges are at the customer's expenses.

Art. 5 DELIVERY TIMES/TERMS

Delivery times and dates are only approximate and are subject to change. Any delays in delivery do not entitle the customer to cancel the order or claim compensation for damages caused by delay of delivery. Delivery times for urgent orders must be agreed directly with RAASM S.p.A. RAASM S.p.A. has the right not to carry out the order and/or totally or partially carry it out, without this giving rise to reimbursement or claims for compensation for damage.

Art. 6 PACKS AND PACKAGING

Packaging costs are included in the price, except for special packing, which shall be charged at cost.

Art. 7 PRICES

The current Price list cancels and replaces the previous price list. In the event of changes to our price list and/or individual items, the goods shall be forwarded at the price in force on the day of the order confirmation. The price list and/or the prices of individual items can be changed even without notice, according to the changes in market conditions or technical innovations/modifications made to the product. The prices are understood to be ex works RAASM S.p.A.

Art. 8 PAYMENTS

Payments must be made exclusively to RAASM S.p.A. at the agreed conditions. Under no circumstances will deductions or roundings be accepted. In case of late payment with respect to the agreed conditions, RAASM S.p.A. reserves the right to charge interest at the current rate, effective from the day after that agreed for payment, plus any additional expenses. Discounts conditional on the payment term and already credited shall be recharged.

Art. 9 WARRANTY

RAASM S.p.A. provides each product with the communication of particular instructions for the installation, use and maintenance requirements and the need to carry out possible checks on the product. All the technical information and data mentioned in the catalogue and in the price-list in force are not binding and can be changed without prior notice for the purpose of improving the quality of the products. All products manufactured by RAASM S.p.A. are guaranteed for a period of 5 (five) years from the date of delivery to the first user. The user must keep and show the sales invoice - or an equivalent document - together with the item's serial number in order to make a claim under the RAASM S.p.A. guarantee. The 5 (five) year guarantee does not apply to components which are subject to normal wear and tear (such as gaskets, diaphragms, O-rings, hoses, etc.), electronic components and items that are sold but not manufactured by RAASM S.p.A. (marked with a red asterisk in the current product catalogue) which are guaranteed for 1 (one) year from the date of delivery to the first user.

1 (one) year warranty is valid also for the following products:

- digital litre counters and FCS system;
- cable reels;
- electric, pneumatic or hydraulic motor supplied with our industrial hose reels S. 600 and 700.

Incorrect installation, use or maintenance of the product shall void the warranty. Upon written notice, the articles must be returned free to our Factory for checking and acceptance. In any case, the guarantee expires in the 10th year from the date of manufacture (indicated by the serial number), if the stated expiry takes place before the expiration terms indicated above (1 or 5 years from delivery to the first user).

The manufacturer declines any responsibility for possible inaccuracies contained in this catalogue, due to printing or transcription errors. The manufacturer reserves the right to make any changes or improvements of a functional, technical or aesthetic nature without prior notice.

RAASM

Art. 10 RESPONSIBILITY

RAASM S.p.A. is exempt from any responsibility and liability for accidents that may occur to persons and property, as a result of or during the use of the equipment, due to or depending on the same whenever the products have been damaged during transport, tampered with or modified, or improperly used, or stored, installed, protected and preserved without complying with the instructions of RAASM S.p.A. as given in the installation, use and maintenance instruction manuals for each product. RAASM S.p.A. is liable for the value for the supplied product and cannot be held responsible in any way for other possible costs or additional costs that the customer may bear.

Art. 11 CONFIDENTIALITY

Information not in the public domain that is exchanged in the execution of the contract is subject to the obligation of confidentiality, secrecy and security; said information is covered as an industrial secret and is of a confidential and reserved nature and may not be disseminated to third parties; its use is permitted exclusively and strictly to execute the supply contract.

Art. 12 INTELLECTUAL PROPERTY RIGHTS

The RAASM trademark, and likewise the name RAASM, RAASM S.p.A., the logo and the other distinctive signs are internationally registered trademarks, and RAASM S.p.A. does not authorise their use and application under any circumstances. Without prior written consent from RAASM S.p.A., the content of catalogues, price lists, instruction manuals and similar, including content on the website may not be reproduced, either entirely or partially, nor may it be transferred by electronic or traditional means, nor may it be modified or utilised by any means and for any purpose. All rights are held by RAASM S.p.A. The customer acknowledges that RAASM S.p.A. holds exclusive ownership of all the parts, images, photographs and signs not in common usage, the content in the catalogues, price lists, instruction manuals and similar and/or present on the website www.raasm.com and/or other channels and/or social networks used by RAASM S.p.A. for their informational and marketing campaigns pursuant to Copyright Law and the Industrial Property Code.

Art. 13 INFORMATION ON THE PROCESSING OF DATA PURSUANT TO ITALIAN LEGISLATIVE DECREE 196/2003

In accordance with article 13 of Italian Legislative Decree 196/2003 - Personal Data Protection Code - you are hereby advised that the processing of the personal data, provided with the purchase of goods or services and/or the supply of goods or services is solely for the purposes of carrying out the contract-based obligations and to comply with the specific requests from customers/ suppliers, as well as adhering to legislative obligations, in particular accounting and tax obligations or to respect orders issued by public authorities or to exercise a right in court. The data shall also be used for commercial statistics for corporate use and to obtain commercial information on our products and services if expressly authorised by the applicant. The processing of data shall be done using hard-copy and computerised procedures, in the manner and within the limits necessary to achieve the aforementioned purposes. Data may be communicated and processed by other companies in the Group for the same specified purposes, and may be made known to employees of our company, consultants and other suppliers, always and exclusively within the limits of the aforementioned purposes. The provision of data is mandatory for the correct execution of the contract and pre-contract based obligations, and failure to do so could result in it being impossible to fully comply with contractual obligations, and make it impossible to provide updates on the new products and services offered by our company. Data shall be processed for the duration of the contract relationship in place and subsequently to fulfil any legal formalities.

Art. 14 RIGHTS OF DATA SUBJECTS

The information is aimed at defining the limits and methods for the processing of data, based on which individual customers and/or suppliers may freely authorise the collection and subsequent use of data. Data subjects are entitled to the rights pursuant to article 7 of the aforementioned Code and in particular, the right to access their personal data, ask for the amendment, update and cancellation thereof, if incomplete, incorrect or collected in violation of the law, and may object to the processing for legitimate reasons, addressing requests in this regard to RAASM S.p.A. Pursuant to the same article the data subject also has the right to request the complete and updated list of the Data Supervisors, and to ask for the cancellation, transformation into anonymous form or blocking of data processed in violation of the law, and to oppose in any case, for legitimate reasons, the processing thereof.

To exercise these rights, and in the case of problems or any requests for clarification regarding what has been explained herein, kindly address these to RAASM S.p.A. - Via Marangoni, 33, Cassola (VI) - Italy or to the following email address: info@raasm.com.

Art. 15 DATA CONTROLLER

The Data Controller is RAASM S.p.A. with registered office at Via Marangoni 33, Cassola (VI) – Italy, and this is where the data processing shall take place.

Art. 16 COMPETENT LAW COURT

Any disputes shall be settled by the Law Court of Vicenza, Italy.

The company RAASM S.p.A. holds the exclusive Intellectual Property rights on the RAASM trademark and all rights to its use and reproduction are reserved. The RAASM trademark is a registered trademark and is protected at an international level. No part of the RAASM trademark and its logo may be utilized, copied and/or used in any form, time and space, even by means of improper alterations.

The Intellectual Property rights on the images published in this catalogue are owned exclusively by RAASM S.p.A. and any unauthorized reproduction is prohibited.

Any use in general of the assets protected by the Intellectual Property rights of RAASM S.p.A. is prohibited and is subject to the prior written permission of RAASM S.p.A.





■ Technology

The research and development of cutting-edge solutions, carried out entirely in Italy, is the starting point for the entire production cycle.



■ Quality

Offering high-quality products is one of our main objectives. Specific and rigorous tests accompany every single stage of the production process.



■ Efficiency

RAASM offers a complete range of fluid management solutions suitable for many different sectors of use. Our success is founded on the ability to identify and satisfy the specific needs of our customers.



Company with quality, environment and safety system according to ISO 9001:2015, ISO 14001:2015 and ISO 45001:2018 standards

RAASM S.p.A.
36022 S. ZENO DI CASSOLA (VI)
Via Marangoni, 33 - ITALY

Export department
Tel. +39 0424 571130 - Fax +39 0424 571135

Technical department
Tel. +39 0424 571150 - Fax +39 0424 571155
info@raasm.com - www.raasm.com



Authorized dealer