

TELWIN[®]
JOIN THE INNOVATION

SINCE 1963

**GO
FURTHER**



**AUTOMOTIVE
CATALOGUE
2023/24**

W

Technology & innovation: in the Automotive sector

Tecnologia e innovazione da 60 anni nel settore Automotive

JOIN THE INNOVATION
and **GO FURTHER**



COMPANY



CERTIFIED QUALITY SYSTEM
UNI EN ISO 9001



CERTIFIED SYSTEM
UNI ISO 45001



CERTIFIED SYSTEM
UNI EN ISO 14001

APPROVED BY

Mercedes Benz



GM General Motors



BMW

PRODUCTS



or for 60 years!

TELWIN®

Watch the company video



WATCH THE VIDEO

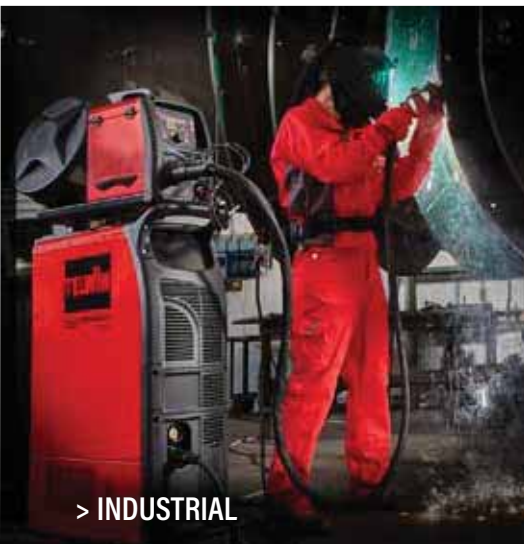

> INDUSTRIAL



> PROFESSIONAL



> CONSUMER

**EN/
FOR 60 YEARS, A COMPANY
LOOKING TO THE FUTURE**

Since 1963, we have been a leader in the global market of spot welding, plasma cutting, battery chargers and starters. Our method is unique, focused on continuous innovation and constant research into absolute quality: this is Made in Telwin, our guarantee.

**IT/
DA 60 ANNI UN'AZIENDA CHE
GUARDA AL DOMANI**

Dal 1963 siamo un punto fermo nel mercato globale della saldatura della puntatura, del taglio al plasma, dei caricabatterie e degli avviatori. Il nostro metodo è unico, incentrato sull'innovazione continua e sulla costante ricerca della qualità assoluta: questo è il Made in Telwin, la nostra garanzia.

**FR/
DEPUIS 60 ANS, UNE ENTREPRISE
TOURNÉE VERS L'AVENIR**

Depuis 1963, nous sommes une référence sur le marché mondial du soudage, du soudage par points, de la découpe au plasma, des chargeurs de batteries et des démarreurs. Notre méthode est exclusive, centrée sur l'innovation continue et sur la recherche constante de qualité absolue : tel est le Made in Telwin, notre garantie.

**ES/
DESDE HACE 60 AÑOS UNA
EMPRESA QUE MIRA AL MAÑANA**

Desde 1963 somos un punto de referencia en el mercado global de la soldadura, la soldadura por puntos, el corte al plasma, los cargadores de baterías y los arrancadores. Nuestro método es único, centrado en la innovación continua y en la búsqueda constante de la calidad absoluta: esto es el Made in Telwin, nuestra garantía.

**DE/
EIN UNTERNEHMEN, DAS SEIT 60
JAHREN NACH VORNE SCHAUT**

Seit 1963 sind wir für den Weltmarkt ein Fels in der Brandung in Bezug auf Punktschweißen, Plasmaschneiden, Batterieladegeräte und Starter. Unser Verfahren ist einzigartig. Stete Innovation und ständiges Streben nach der absoluten Qualität werden in den Mittelpunkt gestellt: Das bedeutet „Made in Telwin“, unsere Garantie.

**PT/
HÁ 60 ANOS UMA EMPRESA QUE
PROJETA O FUTURO**

Desde 1963, somos um ponto de referência no mercado global da soldadura, soldadura por pontos, corte a plasma, carregadores de baterias e arrancadores. O nosso método é único, centrado na inovação contínua e na constante pesquisa da qualidade absoluta: isto é o Made in Telwin, a nossa garantia.

INDEX

Telwin: the home of welding.....	2-3	Smart Inductor 5000	26-27	T-Charge 12, 20, 12EVO, 20EVO, 26EVO.....	63-64
Materials & Automotive.....	4-8	D-Arc, Battery Puller	28-29	Pulse 30 EVO, 50 EVO	65
Choose the right product	9	Puller 4000, Digital Puller 5500	30-31	Doctor Charge INFO, Battery Connect APP	66-68
Technomig 180, 210	10	Digital Puller Duo, Car Spotter 5500	32-34	Doctor Charge 55 Connect, 50, 130.....	69-71
ATC, Technomig 215, 260, 225, 223.....	11-14	Starter Stations, Puller Stations	35-37	Doctor Start, Dynamic, Energy.....	72-75
Electromig 300, 400 Synergic	15	T-Raction 250, Glue repair kit PRO	38-39	Drive, Drive Pro	76-77
Technomig 240 Wave	16	Smart Repair Trolley	40-41	Startzilla XT	78-79
AB Pulse & AB Pop	17	Smart Repair, Dent Pulling, Dent Repair Deluxe.....	42-46	Pro Start, Start Plus	80-81
Technomig 243 Wave	18-19	Digital Spotter 7000, 9000 (Aqua)	47	Battery Testers, Arc protector	82-83
Wave OS, Electromig Wave 230, 330 (Aqua)	20-21	Inverspotter INFO, Qantum	48-51	Professional Welding Helmets	84-86
Technology Plasma 41 XT, 54 XT k	22	Inverspotter 13500, 14000 Smart Aqua, Shark A7	52-58	Safety & Accessories	87
Technology Plasma 60 XT, Superior Plasma 70	23	Modular 20/TI, Digital Mod. 230, 400.....	59	Booster Cables, Automotive Welding Clamps.....	88
Technology Tig 222 AC/DC-HF/LIFT	24	Choose your Products	60	MIG-MAG, PLASMA, SPOT Accessories	89-90
Inductor 3000	25	Charging & Starting INFO, Pulse Tronic INFO	61-62	Legenda	91

MATERIALS & AUTOMOTIVE

- Ultra High Strength Steel
- Extra High Strength Steel
- Very High Strength Steel
- High Strength Steel
- Mild Steel / Forming Grades
- Aluminium
- Magnesium



EN/ These days the design/construction of motor vehicles is characterised by more and more exacting requirements:

- reduction of vehicle weight, with consequent reduced consumption and hence also reduced atmospheric pollution;
- increased structural strength, to respond to increasingly strict crash test standards;
- protection against corrosion of certain metals caused by oxidation.

To respond to these requirements the automotive industry is making increasingly widespread use of materials such as aluminium, high strength steels, galvanised sheet, etc. Repair work in the body shop will have to take account of this situation and welding, spot-welding and cutting operations will therefore require equipment that is able to cope efficiently with particular operational aspects relating, for example, to heat transfer, welding/cutting arc stability, the appearance of the finished job, and then the strength of the weld.

IT/ La progettazione/costruzione delle attuali autovetture è caratterizzata da alcune esigenze sempre più pressanti:

- alleggerimento della vettura, con conseguente riduzione dei consumi e quindi dell'inquinamento atmosferico;
- incremento della resistenza strutturale per rispondere alle norme sempre più restrittive relative ai "crash test";
- protezione alla corrosione di alcuni materiali determinata dalla loro ossidazione.

Per rispondere a questi requisiti, l'industria automobilistica utilizza sempre più diffusamente materiali quali alluminio, acciai ad alta resistenza, lamiere zincate, etc. L'attività di riparazione nel settore carrozzeria deve obbligatoriamente tenere conto di questa realtà e quindi, nelle operazioni di saldatura, puntatura, taglio sono richieste attrezzature in grado di affrontare efficacemente particolari aspetti operativi relativi, ad esempio, all'apporto termico, alla stabilità dell'arco di saldatura/taglio, all'estetica dell'intervento, quindi alla tenuta della saldatura.

FR/ La conception/construction des voitures actuelles se caractérisent par des exigences croissantes:

- allègement de la voiture, avec réduction conséquente des consommations et donc de la pollution atmosphérique;
- accroissement de la résistance structurelle, pour répondre aux normes de plus en plus strictes des essais de choc;
- protection contre la corrosion par oxydation de certains matériaux.

Pour répondre à ces exigences, l'industrie automobile utilise de plus en plus fréquemment des matériaux comme l'aluminium, les aciers haute résistance, les tôles zinguées, etc. L'activité de réparation du secteur de la carrosserie doit obligatoirement tenir compte de cette réalité, et les opérations de soudage, pointage et coupe exigent par conséquent des outils en mesure d'affronter avec efficacité des aspects opérationnels particuliers, par ex. en ce qui concerne l'apport thermique, la stabilité de l'arc de soudage/coupe, l'aspect esthétique de l'intervention et donc la tenue de la soudure.

ES/ El diseño/fabricación de los coches actuales se caracteriza por algunas necesidades cuyo peso es cada vez mayor:

- coches más ligeros, con la consiguiente reducción de los consumos y por lo tanto de la contaminación atmosférica;
- aumento de la resistencia estructural, para responder a las normas cada vez más severas relativas a los "crash tests";
- protección a la corrosión de algunos materiales, determinada por su oxidación.

Para responder a estos requisitos, la industria automovilística utiliza cada vez más materiales como aluminio, aceros de alta resistencia, chapas zincadas, etc.

La actividad de reparación en el sector de la carrocería debe tener en cuenta obligatoriamente esta realidad, y por lo tanto, en las operaciones de soldadura, soldadura por puntos, corte son necesarias herramientas capaces de afrontar de manera eficaz aspectos operativos especiales relativos, por ejemplo, al aporte térmico, a la estabilidad del arco de soldadura/corte, a la estética de intervención, y por lo tanto a la sujeción de la soldadura.

DE/ Einige Anforderungen gewinnen bei der Entwicklung und dem Bau der heutigen Kraftfahrzeuge immer mehr an Bedeutung:

- die Verringerung des Fahrzeuggewichtes, durch die eine Senkung des Kraftstoffverbrauches und der Luftverschmutzung angestrebt wird;
- die Erhöhung der Strukturfestigkeit, die den immer strengeren Auflagen für "Crashtests" genügen muß;
- der Schutz einiger Werkstoffe vor oxidationsbedingter Korrosion.

Um diesen Anforderungen gerecht zu werden, verarbeitet die Automobilindustrie immer häufiger Werkstoffe wie Aluminium, hochfeste Stähle oder verzinkte Bleche, usw. Bei Reparaturen im Karoseriesektor muß diesen Fakten zwingend Rechnung getragen werden: Zum Schweißen, Punkten und Schneiden sind also Ausrüstungen erforderlich, die bestimmten operativen Gesichtspunkte berücksichtigen, etwa was den Wärmeeintrag, die Lichtbogenstabilität beim Schweißen und Schneiden oder das optische Resultat und somit die Festigkeit der Schweißung anbetrifft.

PT/ A concepção/construção dos actuais automóveis caracteriza-se por uma série de necessidades cada vez mais prementes:

- aligeiramento do automóvel, com a consequente redução do consumo de combustível e, consequentemente, da poluição atmosférica;
- aumento da resistência estrutural para satisfazer normas cada vez mais restritivas de "testes de colisão";
- protecção contra a corrosão de certos materiais provocada pela sua oxidação.

Para satisfazer estes requisitos, a indústria automóvel utiliza cada vez mais materiais como o alumínio, aços de alta resistência, chapas galvanizadas, etc.

Os trabalhos de reparação no sector da carroçaria devem necessariamente ter em conta esta realidade e, por conseguinte, nas operações de soldadura, soldadura por pontos e de corte, é necessário equipamento que possa abordar eficazmente aspectos operacionais relacionados, por exemplo, com a entrada de calor, a estabilidade do arco de soldadura/corte, a estética da operação e, por conseguinte, a estanquidade da soldadura.

HIGH STRENGTH STEELS

EN/ Classified into various types (HSS, UHSS, AHSS-e.g boron steel), they are considerably lighter in weight than conventional steel and have improved mechanical properties as regards static and dynamic strength, mouldability and energy absorption. Their use for both structural and non- structural vehicle parts has significantly increased. Welding, spot-welding and cutting operations therefore require equipment that perfectly respects the properties of these materials and ensures a high quality finish for every job.

IT/ Rappresentati in varie tipologie (HSS, UHSS, AHSS-es.acciaio al boro), hanno un peso sensibilmente inferiore all'acciaio convenzionale e caratteristiche meccaniche migliorative circa la resistenza statica e dinamica, la formabilità, l'assorbimento di energia. Significativa è la crescita del loro utilizzo in parti strutturali e non dei veicoli. Le operazioni di saldatura, puntatura e taglio richiedono quindi attrezzature perfettamente rispondenti alle caratteristiche di questi materiali, assicurando in ogni intervento una alta qualità di esecuzione.

FR/ En différents types (HLE, THLE, UHLE-ex. aciers au bore), ils offrent un poids sensiblement inférieur à l'acier classique et des caractéristiques mécaniques supérieures en termes de résistance statique, dynamique, formabilité et absorption d'énergie. Leur utilisation s'accroît de façon significative pour les parties structurelles, et non pour celles du véhicule. Les opérations de soudage, pointage et coupe exigent donc des outils correspondant parfaitement aux caractéristiques de ces matériaux et assurant une haute qualité d'exécution pour tous les types d'interventions.

ES/ Representados en varios tipos (HTS, UHTS, AHTS - Ej. acero al boro), tienen un peso sensiblemente inferior al acero convencional y características mecánicas mejores respecto la resistencia estática y dinámica, la formabilidad, la absorción de energía. Es significativo el crecimiento de su utilización en partes estructurales y no estructurales de los vehículos. Las operaciones de soldadura, soldadura por puntos, y corte requieren, por lo tanto, equipamientos perfectamente adherentes a las características de estos materiales, asegurando en cualquier intervención una alta calidad de ejecución.

DE/ In zahlreichen Sorten vertreten (HSS, UHSS, AHSS- z. B. Borstahl), weisen sie ein erheblich geringeres Gewicht auf als herkömmlicher Stahl. Was die mechanischen Eigenschaften, die statische und dynamische Festigkeit, die Verformbarkeit und die Energieabsorption angeht, schneiden sie besser ab. Bezeichnend ist in diesem Zusammenhang ihre wachsende Bedeutung für tragende und nicht tragende Fahrzeugteile. Zum Schweißen, Punkten und Schneiden sind deshalb Ausrüstungen erforderlich, die genau auf die Eigenschaften dieser Werkstoffe zugeschnitten sind und stets eine hohe Endqualität sicherstellen.

PT/ Representados em vários tipos (HSS, UHSS, AHSS-es. aço boro), têm um peso significativamente inferior ao do aço convencional e características mecânicas melhoradas no que diz respeito à resistência estática e dinâmica, formabilidade, e absorção de energia. Significativo é o aumento da sua utilização em peças estruturais e não estruturais de veículos. As operações de soldadura, soldadura por pontos e corte requerem, portanto, equipamentos que correspondam perfeitamente às características destes materiais, garantindo uma alta qualidade de execução em cada operação.

ALUMINIUM

EN/ Present in the form of various alloys (AlSi, AlMg, AlMn), it is characterised by being considerably lighter than steel, by its ductility, corrosion resistance and recyclability. Its high thermal conductivity and the presence of a surface film of oxide, alumina, require specific working methods such as TIG welding AC, MIG pulsed welding, or drawn arc.

IT/ Presente sotto forma di varie leghe (AlSi, AlMg, AlMn) si caratterizza per la notevole leggerezza rispetto all'acciaio, la duttilità, la resistenza alla corrosione e la riciclabilità. La sua elevata conducibilità termica e la presenza di una pellicola superficiale di ossido, l'allumina, richiedono tecniche specifiche di intervento quali, ad esempio, saldatura TIG-AC, MIG pulsato o arco corto.

FR/ En différents types d'alliages (AlSi, AlMg, AlMn), se caractérise par sa remarquable légèreté par rapport à l'acier, sa ductilité, sa résistance à la corrosion et sa capacité de recyclage. Sa conductibilité thermique élevée et la présence d'une pellicule superficielle d'oxyde, l'alumine, exigent des techniques d'intervention spécifiques, comme par ex. le soudage TIG-CA, MIG pulsé, le soudage à arc court.

ES/ Presente bajo forma de varias aleaciones (AlSi, AlMg, AlMn) se caracteriza por la notable ligereza respecto al acero, la ductilidad, la resistencia a la corrosión y la reciclabilidad. Su elevada conductividad térmica y la presencia de una película superficial de óxido, la alúmina, requieren técnicas específicas de intervención como, por ejemplo, soldadura TIG-AC, MIG pulsado, soldadura de arco corto.

DE/ Dieser in verschiedenen Legierungen (AlSi, AlMg, AlMn) verwendete Werkstoff zeichnet sich im Vergleich zum Stahl durch sein geringes Gewicht, seine Streckbarkeit, Korrosionsbeständigkeit und Wiederverwendbarkeit aus. Wegen seiner guten Wärmeleitfähigkeit und der oberflächlichen Aluminiumoxidschicht sind spezielle Verfahrenstechniken erforderlich, etwa das AC-WIG, pulsierte MIG-Schweißen, oder die Kurzlichtbogen-Technologie.

PT/ Presente sob a forma de várias ligas (AlSi, AlMg, AlMn) caracteriza-se pela sua notável leveza em comparação com o aço, ductibilidade, resistência à corrosão e reciclabilidade. A sua elevada condutividade térmica e a presença de uma película de óxido de superfície, a alumina, exigem técnicas específicas como, por exemplo, a soldadura TIG-AC, MIG pulsada, soldadura a tecnologia de arco curto.

GALVANISED SHEET METAL

EN/ Characterised by a protective treatment, galvanisation, of carbon steel and high strength steel sheet these materials have high corrosion resistance. Repair work should therefore prevent damage to this protection by making use of working methods with low heat transfer, such as CuSi₃ braze welding.

IT/ Caratterizzate da un trattamento protettivo, la zincatura, effettuato su lamiere di acciai al carbonio o ad alta resistenza, offrono una elevata protezione alla corrosione. Gli interventi di riparazione devono salvaguardare tale protezione sfruttando tecniche operative a basso apporto termico come la saldobrasatura CuSi₃.

FR/ Caractérisées par un traitement de protection, le zingage, effectué sur des tôles d'acier au carbone ou haute résistance, elles offrent une protection élevée contre la corrosion. Les interventions de réparation doivent par conséquent préserver cette protection en utilisant des techniques opérationnelles à bas apport thermique, comme le soudobrasage CuSi₃.

ES/ Caracterizadas por un tratamiento de protección, el zincado, efectuado sobre chapas de acero al carbono de alta resistencia, ofrecen una elevada protección a la corrosión. Por lo tanto, las intervenciones de reparación deben salvaguardar dicha protección aprovechando técnicas operativas de bajo aporte térmico como la cobresoldadura CuSi₃.

DE/ Bleche aus Kohlenstoffstahl oder hochfestem Stahl werden einer speziellen Behandlung, der Verzinkung, unterzogen und bieten dadurch einen wirksamen Korrosionsschutz. Bei Reparaturarbeiten muß dieser Schutz durch Verfahren mit geringem Wärmeeintrag, etwa das CuSi₃-Lötschweißen, bewahrt werden.

PT/ Caracterizados por um tratamento de protecção, a galvanização, realizada em chapas de carbono ou aços de alta resistência, oferecem uma elevada protecção contra a corrosão. Os trabalhos de reparação devem salvaguardar esta protecção, utilizando técnicas de operação com baixa entrada de calor, tais como a soldadura por brasagem CuSi₃.

MIG BRAZING

EN/ THE SOLUTION FOR WORKING ON GALVANISED SHEET.

It makes it possible to work at lower temperatures (900°C) compared to traditional MIG welding (1500°C). Only the weld material (CuSi3 or CuAl8) is melted during welding, thus preventing damage to the protective layer of zinc, also on the surface opposite to the welding process. Reduced heat transfer leads to reduced distortion and low perforation risk to the galvanized sheet. Finishing work is therefore much simpler.

IT/ LA SOLUZIONE PER OPERARE SU LAMIERE ZINCATE.

Permette di lavorare a temperature più basse (900°C) rispetto alla tradizionale saldatura MIG (1500°C). La saldatura avviene con la sola fusione del materiale di apporto (CuSi3 o CuAl8) evitando così di danneggiare la protezione dello strato di zinco anche sulla superficie opposta alla lavorazione. Il limitato apporto termico consente una ridotta distorsione ed un basso rischio di perforazione della lamiera zincata.

Il lavoro di rifinitura viene quindi notevolmente semplificato.

FR/ LA SOLUTION POUR TRAITER LES TÔLES ZINGUÉES.

Permet de travailler à des températures plus basses (900°C) qu'avec le soudage classique MIG (1500°C). Le soudage s'effectue uniquement au moyen de la fusion du matériau d'apport (CuSi3 ou CuAl8), ce qui évite ainsi d'endommager la protection de la couche de zinc, y compris sur la surface opposée au traitement. L'apport thermique limité permet une distorsion réduite et un faible risque de perforation de la tôle zinguée. Le travail de finition s'en trouve remarquablement simplifié.

ES/ LA SOLUCIÓN PARA TRABAJAR EN CHAPAS ZINCADAS.

Permite trabajar a temperaturas más bajas (900°C) respecto a la tradicional soldadura MIG (1500°C). La soldadura se produce sólo con la fusión del material de aporte (CuSi3 o CuAl8) evitando de esta manera dañar la protección de la capa de zinc incluso en la superficie opuesta a la elaboración. El limitado aporte térmico permite una reducida distorsión y un bajo riesgo de perforación de la chapa zincada. Por lo tanto, el trabajo de acabado se simplifica notablemente.

DE/ DIE LÖSUNG ZUM BEARBEITEN VERZINKTER BLECHEN, die mit geringeren Temperaturen (900°C) auskommt, als das herkömmliche MIG-Schweißverfahren (1500°C). Geschweißt wird ausschließlich durch das Schmelzen des Zusatzwerkstoffes (CuSi3 oder CuAl8). Dadurch wird der Schutz der Zinkschicht auch auf der Seite nicht beschädigt, die der bearbeiteten Fläche abgewandt ist. Durch den vergleichsweise geringen Wärmeeintrag verzieht sich das Blech nur wenig, die Lochbrandgefahr ist gering. Nachbearbeitungen werden dadurch erheblich vereinfacht.

PT/ A SOLUÇÃO PARA TRABALHAR EM CHAPAS GALVANIZADAS.

Permite trabalhar a temperaturas mais baixas (900°C) do que a tradicional soldadura MIG (1500°C). A soldadura realiza-se com a apenas fusão do material de enchimento (CuSi3 ou CuAl8), evitando assim danos na protecção da camada de zinco, mesmo na superfície oposta ao trabalho. A entrada limitada de calor permite uma distorção reduzida e um baixo risco de perfuração da chapa galvanizada. Os trabalhos de acabamento são assim consideravelmente simplificados.

MIG WELDING

EN/ Material that is thin and has particular physical properties needs to be worked at low current levels and it is therefore necessary to use equipment that guarantees efficient control (DYNAMIC SHORT ARC) of the welding parameters (low heat transfer, arc stability, lack of spatter, good looking weld, clean weld pool etc.). Excellent results are guaranteed by using the MIG PULSED functions present on the SYNERGIC power sources, where making the parameter settings is simplicity itself.

IT/ Spessori sottili e particolari caratteristiche fisiche dei materiali richiedono di operare a bassi livelli di corrente e quindi necessitano di attrezzature che garantiscano un efficace controllo (DYNAMIC SHORT ARC) dei parametri di saldatura (basso trasferimento di calore, stabilità dell'arco, assenza di spruzzi, estetica della saldatura, pulizia del bagno, etc.). Risultati eccellenti sono garantiti dall'utilizzo della funzionalità in MIG PULSATO, presente su generatori SINERGICI, i quali permettono una estrema semplicità di impostazione dei parametri.

FR/ Les épaisseurs réduites et les caractéristiques physiques particulières des matériaux exigent d'intervenir à des niveaux de courant réduits et donc des outils garantissant un contrôle effectif (DYNAMIC SHORT ARC) des paramètres de soudage (faible transfert de chaleur, stabilité de l'arc, absence de projections, aspect esthétique du soudage, propreté du bain, etc.). D'excellents résultats sont assurés avec l'utilisation de la fonction MIG PULSÉ, prévue sur les générateurs SYNERGIQUES, qui offrent une grande simplicité de configuration des paramètres.

ES/ Espesores finos y especiales características físicas de los materiales requieren operar a bajos niveles de corriente y por lo tanto necesitan equipamientos que garanticen un eficaz control (DYNAMIC SHORT ARC) de los parámetros de soldadura (baja transferencia de calor, estabilidad del arco, ausencia de salpicaduras, estética de la soldadura, limpieza del baño, etc.).

Se garantizan resultados excelentes con la funcionalidad en MIG PULSADO, presente en los generadores SINERGICOS, los cuales permiten una extrema sencillez de programación de los parámetros.

DE/ Geringe Wandstärken und besondere physikalische Eigenschaften der Werkstoffe erfordern bei der Arbeit geringe Strompegel und somit Ausrüstungen, die eine wirksame Steuerung (DYNAMIC SHORT ARC) der Schweißparameter sicherstellen (geringe Wärmeübertragung, Lichtbogenstabilität, keine Schweißspritzer, Optik der Schweißstelle, Reinheit des Schmelzbades, etc.). Vorzügliche Ergebnisse sind garantiert mit der Betriebsart MIG PULSIERT bei SYNERGISTISCHEN Generatoren, deren Schweißparameter sich auf einfachste Weise verstellen lassen.

PT/ As espessuras finas e as características físicas particulares dos materiais exigem um funcionamento a baixos níveis de corrente e, portanto, necessitam de equipamento que garanta um controlo eficaz (ARCO CURTO DINAMICO) dos parâmetros de soldadura (baixa transferência de calor, estabilidade do arco, ausência de salpicos, estética de soldadura, limpeza do banho, etc.). Excelentes resultados são garantidos pela utilização da funcionalidade PULSED MIG, presente nos geradores SYNERGIC, que permitem a parametrização extremamente simples.

ALUMINIUM (AL)



PULSE



POP - PULSE ON PULSE

PLASMA CUTTING

EN/ The hardness of the new materials (HSS, UHSS etc.) requires the use of plasma cutting systems to replace traditional mechanical cutting tools. In addition, with inverter technology, working at minimum currents, it is possible to work on sheets that are near each other and cut the top one without cutting into the one underneath.

IT/ Le caratteristiche di durezza dei nuovi materiali (HSS, UHSS,...) richiedono l'utilizzo di impianti di taglio al plasma in sostituzione degli utensili meccanici tradizionali. Grazie alla tecnologia inverter, inoltre, l'intervento a basse correnti consente di operare su lamiere ravvicinate riuscendo a tagliare quella superiore senza incidere quella inferiore.

FR/ Les caractéristiques de dureté des nouveaux matériaux (HLE, THLE,...) exigent l'utilisation d'installations de coupe au plasma au lieu des outils mécaniques classiques. Grâce à la technologie inverter, l'intervention à des courants minimaux permet de traiter des tôles proches en découpant la tôle supérieure sans endommager la tôle inférieure.

ES/ Las características de dureza de los nuevos materiales (HTS, UHTS,...) requieren la utilización de instalaciones de corte al plasma en sustitución de las herramientas mecánicas tradicionales. Gracias a la tecnología inverter, además, la intervención a mínimas corrientes permite operar en chapas cercanas, consiguiendo cortar la superior sin incidir en la inferior.

DE/ Die Härteeigenschaften der neuen Werkstoffe (HSS, UHSS,...) erfordern den Einsatz von Plasmaschneideanlagen anstatt traditioneller mechanischer Werkzeuge. Dank der Invertertechnik läßt sich mit Kleinströmen das obere von zwei nahegelegenen Blechen durchtrennen, ohne das untere anzuschneiden.

PT/ As características de dureza dos novos materiais (HSS, UHSS,...) exigem a utilização de equipamento de corte a plasma para substituir as ferramentas mecânicas tradicionais. Além disso, graças à tecnologia de inversor, o funcionamento com corrente mínima permite trabalhar em chapas fechadas, conseguindo cortar a superior sem cortar a inferior.

EMF SAFE WITH TELWIN PRODUCTS

ALL TELWIN'S PRODUCTS COMPLY WITH THE CE MARKING THANKS TO THE EMF DECLARATIONS OF CONFORMITY.

EN/ The publication of the standard EN 62822-1/2/3:2016 (product family standard to demonstrate compliance of equipment for resistance welding, arc welding and allied processes with the basic restrictions related to human exposure to electromagnetic fields) under the Low Voltage Directive LVD 2014/35/EU – published on the Official Gazette of the European Community, requires that each product, in order to be CE certified, has to satisfy the technical standards of the above described norm. This means that the CE marking requires a further certification. Telwin certifies that all its products are in compliance with the CE marking as reported in the EMF Conformity Certificates.

IT/ La normativa EN 62822-1/2/3:2016 (standard volto a dimostrare la rispondenza di apparecchiature per la saldatura a resistenza, arco e processi affini, al soddisfacimento dei limiti relativi all'esposizione umana ai campi elettromagnetici) recepita nella Direttiva Bassa Tensione LVD 2014/35/EU con pubblicazione nella Gazzetta Ufficiale della Comunità Europea, richiede che ogni prodotto, per essere certificato CE, soddisfi gli standard tecnici della norma sopra descritta. Questo significa che la marcatura CE richiede una ulteriore certificazione. Telwin certifica che tutti i prodotti sono conformi alla marcatura CE grazie alle Dichiarazioni di Conformità EMF.

FR/ L'exécution des normes EN 62822-1/2/3:2016 (indiquant la conformité des appareils de soudage par résistance, à arc et procédés liés, et la conformité des limites relatives à l'exposition humaine aux champs électromagnétiques) dans la Directive Basse Tension LVD 2014/35/EU publiées par la Gazette Officielle de la Communauté Européenne impose que tous les produits soient conformes aux normes techniques décrites plus haut pour être certifiés CE. Cela signifie que le marquage CE exige une certification supplémentaire. Telwin certifie que tous ses produits sont conformes au marquage CE grâce à la déclaration de conformité EMF.

ES/ La transposición de la normativa EN 62822-1/2/3:2016 (norma para demostrar la correspondencia de aparatos para la soldadura de resistencia, arco y procesos afines para el cumplimiento de los límites relativos a la exposición humana a los campos electromagnéticos) en la Directiva de Baja Tensión LVD 2014/35/EU publicada en el Diario Oficial de la Comunidad Europea, requiere que todos los productos, para ser certificados CE, cumplan los requisitos técnicos de la norma antes descrita. Esto significa que el marcado CE requiere una ulterior certificación. Telwin certifica que todos los productos son conformes al marcado CE gracias a las declaraciones de conformidad EMF.

DE/ Die Aufnahme der EN 62822-1/2/3:2016 Norm (Produktfamilienorm zur Konformitätsprüfung von Einrichtungen zum Widerstandsschweißen, Lichtbogenschweißen und artverwandten Prozessen in Bezug auf die bei der Exposition durch elektromagnetische Felder anzuwendenden Basisgrenzwerte) in die LVD 2014/35/EU Niederspannungsrichtlinie mit Veröffentlichung im Amtsblatt der Europäischen Gemeinschaft verlangt, daß jedes Produkt die technischen Standards der o.g. Norm erfüllt, um CE-zertifiziert zu werden. Das bedeutet wie folgt zur CE-Kennzeichnung ist eine weitere Zertifizierung erforderlich. Telwin zertifiziert durch seiner EMF Konformitätserklärungen, daß alle Produkte der CE-Kennzeichnung gemäß sind.

PT/ A publicação da norma EN 62822-1/2/3:2016 (norma relativa a família de produtos para demonstrar a conformidade do equipamento com a soldadura de resistência, soldadura por arco e processos afins com as restrições básicas relacionadas com a exposição humana a campos eletromagnéticos) sob a Diretiva Baixa Voltagem LVD 2014/35/EU – publicada no Diário Oficial da Comunidade Europeia, requer que cada produto, para receber certificação CE, tem que cumprir os requisitos técnicos estabelecidos pela norma descrita acima. Isto significa que a marcação CE necessita de uma certificação adicional. A Telwin certifica que todos os seus produtos estão em conformidade com a marcação CE, conforme mencionado nos Certificados de Conformidade EMF.



INVERTER PLUS

EN/ Medium frequency direct current (MFDC) inverter technology guarantees considerable advantages compared to traditional low frequency alternating current systems:

- Lower absorption: DC current allows for an increase in the power factor and hence a noticeable reduction in current absorption from the power supply line.
- Reduction in welding time, with exponential decrease in thermal overheating of the clamp.
- High power and compactness: inverter technology makes it possible to reduce the size of the welding clamp (built-in transformer) by developing very high currents.
- Control of the spot-welding parameters: inverter technology, controlled by the automatic SMART system, allows the welding parameters (intensity, time and pressure) to be identified in a totally autonomous manner.
- The traceability of welding spots allows the registration of welds performed and their certification.

The high pressure parameters at the clamp and the high currents developed at the inverter allow for higher class spot welds, avoiding material projections even on larger thicknesses (>3mm).

IT/ La tecnologia ad inverter in corrente continua a media frequenza (MFDC) garantisce notevoli vantaggi rispetto ai sistemi tradizionali a bassa frequenza in corrente alternata:

- Minore assorbimento: la corrente in DC favorisce un aumento del fattore di potenza, quindi una notevole riduzione dell'assorbimento di corrente dalla linea di alimentazione.
- Riduzione dei tempi di saldatura: con diminuzione esponenziale del surriscaldamento termico della pinza
- Elevata potenza e compattezza: La tecnologia inverter consente di ridurre le dimensioni della pinza di saldatura (trasformatore incorporato) sviluppando correnti molto elevate
- Controllo dei parametri di saldatura, la tecnologia inverter, controllata dal sistema automatico SMART, permette di individuare i parametri di saldatura (intensità, tempo e pressione) in modo totalmente autonomo.
- La tracciabilità dei punti di saldatura permette la registrazione delle saldature effettuate e la relativa certificazione

Gli alti parametri di pressione alla pinza e le alte correnti sviluppate all inverter, permettono saldature a punti di classe superiore evitando proiezioni di materiale anche su spessori più importanti (>3mm).

FR/ La technologie a inverseur en courant continu à fréquence moyenne (MFDC) garantit des avantages remarquables par rapport aux systèmes traditionnels à basse fréquence en courant alternatif:

- Absorption réduite: le courant CC favorise l'augmentation du facteur de puissance et donc une réduction notable de l'absorption de courant par la ligne d'alimentation.
- Réduction du temps de soudage, avec une diminution exponentielle de la surchauffe thermique de la pince.
- Puissance élevée et compacité : la technologie de l'onduleur permet de réduire la taille de la pince à souder (transformateur intégré) tout en développant des courants très élevés.
- Contrôle des paramètres de soudage : la technologie inverter, contrôlée par le système automatique SMART, permet d'identifier les paramètres de soudage (intensité, temps et pression) de manière totalement autonome.
- La traçabilité des points de soudure permet l'enregistrement des soudures effectuées et leur certification.

Les paramètres de pression élevés au niveau de la pince et les courants élevés développés au niveau de l'onduleur permettent de réaliser des soudures par points de classe supérieure, en évitant les projections de matériau, même sur des épaisseurs plus importantes (> 3 mm).

ES/ La tecnología por inverter en corriente continua a media frecuencia (MFDC) garantiza notables ventajas respecto a los sistemas tradicionales de baja frecuencia en corriente alterna:

- Menor absorción: la corriente en CC favorece un aumento del factor de potencia, por lo tanto una notable reducción de la absorción de corriente de la línea de alimentación.
- Reducción del tiempo de soldadura, con disminución exponencial del sobrecalentamiento térmico de la pinza.
- Alta potencia y compactidad: la tecnología Inverter permite reducir el tamaño de la pinza de soldar (transformador incorporado) al tiempo que desarrolla corrientes muy elevadas.
- Control de los parámetros de soldadura, la tecnología inverter, controlada por el sistema automático SMART, permite identificar los parámetros de soldadura (intensidad, tiempo y presión) de forma totalmente autónoma.
- La trazabilidad de los puntos de soldadura permite el registro de las soldaduras realizadas y su certificación.

Los parámetros de alta presión en la pinza y las altas corrientes desarrolladas en el inversor permiten soldaduras por puntos de clase superior, evitando proyecciones de material incluso en espesores mayores (>3mm).

DE/ Die Invertertechnik mit mittelfrequentem Gleichstrom (MFDC) hat gegenüber herkömmlichen Systemen mit niederfrequentem Wechselstrom erhebliche Vorteile:

- Geringere Stromaufnahme: der Gleichstrom DC führt zu einem höheren Leistungsfaktor und somit zu einer merklich reduzierten Stromaufnahme von der Versorgungsleitung.
- Verkürzung der Schweißzeit, mit exponentieller Abnahme der thermischen Überhitzung der Klemme.
- Hohe Leistung und Kompaktheit: Die Invertertechnologie ermöglicht es, die Größe der Schweißzange zu reduzieren (eingebauter Transformator) und gleichzeitig sehr hohe Ströme zu entwickeln.
- Steuerung der Schweißparameter: Die Invertertechnologie, die vom automatischen SMART-System gesteuert wird, ermöglicht eine völlig unabhängige Bestimmung der Schweißparameter (Intensität, Zeit und Druck).
- Die Rückverfolgbarkeit der Schweißpunkte ermöglicht die Registrierung der durchgeführten Schweißungen und deren Zertifizierung.

Die hohen Druckparameter an der Zange und die hohen Ströme, die am Inverter entwickelt werden, ermöglichen Punktschweißungen höherer Klasse, wobei Materialüberstände auch bei größeren Dicken (>3mm) vermieden werden.

PT/ A tecnologia de inversor de corrente contínua de média frequência (MFDC) oferece vantagens significativas sobre os sistemas convencionais de corrente alternada de baixa frequência:

- Menor absorção: a corrente DC favorece um aumento do factor de potência, reduzindo assim significativamente a absorção da corrente a partir da linha de alimentação.
- Redução do tempo de soldadura, com diminuição exponencial do sobreaquecimento térmico da braçadeira.
- Alta potência e compactidade: A tecnologia de inversor torna possível reduzir o tamanho da braçadeira de soldadura (transformador incorporado) enquanto se desenvolvem correntes muito altas.
- Controlo dos parâmetros de soldadura: A tecnologia de inversor, controlada pelo sistema automático SMART, permite que os parâmetros de soldadura (intensidade, tempo e pressão) sejam determinados de forma completamente independente.
- A traçabilidade dos pontos de soldadura permite o registo das soldaduras realizadas e a sua certificação.

Os parâmetros de alta pressão na pinça e as altas correntes desenvolvidas no inversor permitem soldaduras pontuais de classe superior, evitando projecções de material mesmo em espessuras maiores (>3mm).

AUTOMOTIVE CHOICE TABLE

TABELLA DI SCELTA PER AUTOMOTIVE - TABLEAU DE CHOIX POUR AUTOMOTIVE - TABLA DE ELECCIÓN PARA AUTOMOTIVE
- WAHLSTAFEL FÜR AUTOMOTIVE - TABELA DE SELEÇÃO PARA AUTOMOTIVE

		MIG-MAG		PROCESS		MODES		ADVANCED ARCS			WEIGHT	
				TIG-LIFT	MMA	ONE TOUCH	WAVE OS	ATC FOR THIN THICKNESSES	AB-PULSE AB-POP PULSED & DOUBLE PULSED FOR ALUMINIUM & CuSi ₃	ROOT-MIG IDEAL FOR STEEL	POLARITY REVERSAL	WEIGHT (kg)
INVERTER												
1ph	TECHNOMIG 180 DUAL SYNERGIC	20-170	140@20%	■	■	■					■	11
	TECHNOMIG 210 DUAL SYNERGIC	20-200	180@20%	■	■	■					■	13
	TECHNOMIG 215 DUAL SYNERGIC	20-220	180@20%	■	■	■		■			■	22
	TECHNOMIG 225 DUAL SYNERGIC	20-220	180@20%	■	■	■		■			■	30
	TECHNOMIG 260 DUAL SYNERGIC	20-250	220@20%	■	■	■		■			■	22
	TECHNOMIG 223 TREO SYNERGIC	20-220	180@20%	■	■	■		■			■	52
	TECHNOMIG 240 WAVE	20-220	200@20%	■	■		■		■		■	24
	TECHNOMIG 243 WAVE	20-220	180@20%	■	■		■		■			59
3ph	ELECTROMIG 300 SYNERGIC	20-300	270@30%	■	■	■		■				37
	ELECTROMIG 400 SYNERGIC	20-400 (400V)	400@30%	■	■	■		■				42
		20-230 (230V)	320@25%									
	ELECTROMIG 230 WAVE	10-240	200@20%	■	■		■		■	■		32
ELECTROMIG 330 WAVE	20-300	270@30%	■	■		■		■	■		39	

	DENT REPAIR		SPOT WELDING			
	ALUMINIUM	STEEL	SINGLE SPOT	MILD STEEL	HSS, HLE, HTS	UHSS, UHLE, UHTS
D-ARC 200	■					
BATTERY PULLER		■				
PULLER 4000		■				
DIGITAL PULLER 5500 DUO		■				
DIGITAL PULLER 5500		■				
DIGITAL CAR SPOTTER 5500		■	■	■ with OPTIONAL 801043		
DIGITAL SPOTTER 7000		■ with OPTIONAL 802832	■ with OPTIONAL 802832	■		
DIGITAL SPOTTER 9000		■ with OPTIONAL 802832	■ with OPTIONAL 802832	■	■	
INVERSPOTTER 13500 SMART AQUA		■ with OPTIONAL 802699	■ with OPTIONAL 802699	■	■	■
INVERSPOTTER 14000 SMART AQUA		■ with OPTIONAL 802699	■ with OPTIONAL 802699	■	■	■
MODULAR 20/TI				■		
DIGITAL MODULAR 230				■		
DIGITAL MODULAR 400				■		

TECHNOMIG 180 - 210 DUAL SYNERGIC

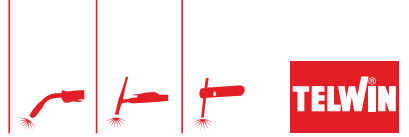

inverter

MULTIPROCESS
MIG - MMA - TIG

ONE TOUCH
LCD SYNERGY



TIG LIFT



STANDARD

OPTIONAL

→ CONSUMABLES MIG-MAG Pag. 89

3m MT15
742180
0,6÷0,9mm
mod. 180 - 722529
0,6÷0,8mm
mod. 210 - 722019
GAS
TUBE
1,8m
AX25

BOXES
MIG BREADY BOX C
804149

CONSUMABLES BOX
804137

GAS REGULATOR
722119

QUICK GAS CONNECTOR
804208

MMA - MIG/MAG TIG MASK
STREAM FLAME
804235
More masks pag. 84



ALUMINIUM KIT
802115

STAINLESS STEEL KIT
802037

MIG-MAG TORCH
MT15
4m 742181

NAIL SPOT WELDING KIT
802034

ELECTRODE HOLDER
16mm² 3m AX25
804121

TIG TORCH
ST9V
4m 722563

TROLLEY ARCTIC
803059



TROLLEY AMERICA
803084



TECHNICAL DATA

CE EAC	CODE	V _{1PH} V (50-60Hz)	A _{MIN} / A _{MAX} DC	A _{MAX} 40°C DC EN 60974-1	A _{MAX} 60°C DC EN 60974-1	V _O DC	A _{MAX}	A _{60%}	P _{MAX}	P _{60%}	η	φ	φ _{DC} MIN/MAX	EST	OSS	AL	FX	BZ	IP	LxWxH cm	kg	
TECHNOMIG 180 DUAL SYNERGIC	816075	230 1ph	20 - 170	140 @ 20%	80	44	22	11	3,2	1,6	16	86	0,7	1,6 3,2	0,6 0,8	0,8	0,8 1	0,8 1,2	0,8	IP23	46 x 24 x 36	11
TECHNOMIG 210 DUAL SYNERGIC	816231	230 1ph	20 - 200	180 @ 20%	100	52	32	15	5	2,2	-	85	0,7	1,6 3,2	0,6 1	0,8 1	0,8 1	0,8 1,2	0,8 1	IP23	46 x 24 x 36	13

EN/ MIG-MAG/FLUX/BRAZING and TIG DC-Lift inverter wire welding machines. The SYNERGIC adjustment of the welding parameters thanks to the "ONE TOUCH" technology, makes the products very easy to use. Complete with MIG-MAG torch, cable and earth clamp.

FR/ Postes de soudage inverter à fil MIG-MAG/ FLUX/ BRAZING et TIG DC-Lift. Le réglage rapide SYNERGIQUE des paramètres de soudage grâce à la technologie "ONE TOUCH", rend les produits très simples à utiliser. Fournis avec torche de soudage MIG-MAG, câble et pince de masse.

DE/ MIG-MAG/FLUX/BRAZING und TIG DC-Lift Drahtschweißgeräte mit Invertertechnik. Durch die zügige Einstellung der SYNERGISTISCHEN Schweißparameter, dank der Technologie "ONE TOUCH", ist das Produkt äußerst bedienungsfreundlich. Komplet mit MIG-MAG-Brenner, Massekabel und Masseklemme.

IT/ Saldatrici inverter a filo MIG-MAG/FLUX/BRAZING/ MMA e TIG DC-Lift. La regolazione SINERGICA dei parametri di saldatura, grazie alla tecnologia ONE TOUCH, rende questi prodotti facili da usare. Complete di torcia MIG-MAG, cavo e pinza di massa.

ES/ Soldadoras inverter de hilo MIG-MAG/FLUX/BRAZING y TIG DC-Lift. La rápida regulación SINÉRGICA de los parámetros de soldadura gracias a la tecnología "ONE TOUCH", vuelve el producto muy simple de usar. Equipadas con soplete MIG-MAG, cable y pinza de masa.

PT/ Aparelhos de soldar inverter, MIG-MAG/FLUX/ BRASAGEM/MMA e TIG DC-Lift. O ajuste SINÉRGICO dos parâmetros de soldadura, graças à tecnologia ONE TOUCH, torna estes produtos fáceis de usar. Fornecidos com tocha MIG-MAG, cabo e pinça.

MIG-MAG PROCESS ON THIN MATERIALS

EN/ The Made in Telwin ATC technology is designed for use in specific sectors such as, for example, car bodywork where the materials (with thin materials measuring from 0.5-0.8 mm) are extremely sensitive to deformation caused by the temperatures reached during welding operations. The ATC technology makes it easy to achieve excellent standards of welding on thin materials thanks to state-of-the-art control of the arc.

IT/ La tecnologia ATC, Made in Telwin, trova specifica applicazione in quei settori, vedi ad esempio la carrozzeria, dove i materiali (con spessori contenuti tra 0,5-0,8mm) sono estremamente sensibili alle deformazioni causate dalle temperature raggiunte durante la saldatura. La tecnologia ATC consente di ottenere con grande facilità eccellenti saldature su spessori sottili grazie ad un controllo avanzato dell'arco.

FR/ La technologie ATC, Made in Telwin, trouve une application spécifique dans ces secteurs, voir par exemple la carrosserie, où les matériaux (ayant des épaisseurs contenues entre 0,5-0,8 mm) sont extrêmement sensibles aux déformations causées par les températures atteintes durant le soudage. La technologie ATC permet d'obtenir avec grande facilité d'excellents soudages sur de fines épaisseurs grâce à un contrôle avancé de l'arc.

ES/ La tecnología ATC, Made in Telwin, encuentra su aplicación específica en aquellos sectores, véase por ejemplo la carrocería, donde los materiales (con espesores incluidos entre 0,5-0,8 mm) son extremadamente sensibles a las deformaciones que causan las temperaturas que se alcanzan durante la soldadura. La tecnología ATC permite obtener con gran facilidad soldaduras excelentes en espesores sutiles, gracias a un control avanzado del arco.

DE/ Die ATC-Technologie von Telwin findet - etwa in Karosseriebetrieben - speziell dort Anwendung, wo die Werkstoffe (mit relativ geringen Stärken von 0,5 bis 0,8 mm) äußerst empfindlich auf die Verformungen reagieren, die auf hohe Temperaturen beim Schweißen zurückgehen. Mit der ATC-Technologie lassen sich auf dünnwandigen Werkstoffen dank einer hochentwickelten Lichtbogensteuerung mühelos ausgezeichnete Schweißresultate erzielen.

PT/ A tecnologia ATC, Made in Telwin, foi concebida para trabalhos específicos, por exemplo em carroçarias de veículos, onde os materiais (com espessuras entre 0,5-0,8 mm) são extremamente sensíveis à deformação causada pelas temperaturas alcançadas durante as operações de soldadura. A tecnologia ATC permite obter excelentes resultados em aço, alumínio e brasagem de espessuras finas, graças ao controlo avançado do arco.

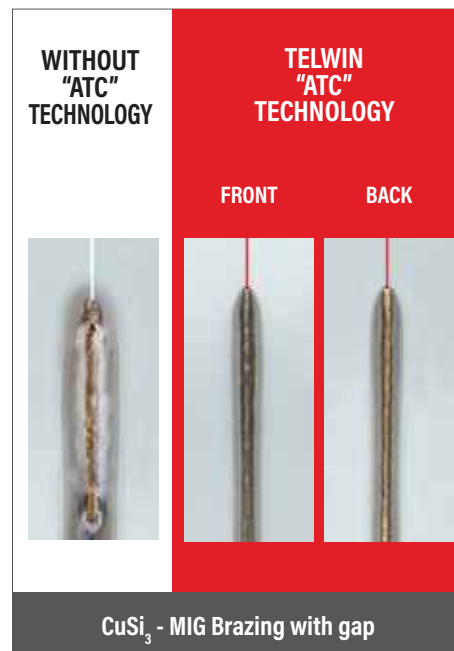

ADVANTAGES

- EN/**
- Easy welding of thin materials
 - Decreased deformation of material
 - Extremely stable arc even when working with low currents
 - Rapid and accurate tack welding
 - Easier coupling of spaced sheets
 - Excellent results on steel, aluminium and during brazing operations

- IT/**
- Saldature su spessori sottili con grande facilità
 - Minore deformazione del materiale
 - Arco estremamente stabile anche alle basse correnti
 - Saldatura a punti rapida e precisa
 - Unione facilitata di lamiere distanziate tra loro
 - Ottimi risultati su acciaio, alluminio e con saldobrasatura

- FR/**
- Soudages sur de fines épaisseurs avec grande facilité
 - Plus faible déformation du matériel
 - Arc extrêmement stable même avec des courants faibles
 - Soudage par points rapide et précis
 - Union facilitée de tôles distancées entre elles
 - Excellents résultats sur acier, aluminium et avec brasage

- ES/**
- Soldaduras en espesores sutiles con gran facilidad
 - Menor deformación del material
 - Arco extremadamente estable incluso con corrientes bajas
 - Soldadura por puntos rápida y precisa
 - Unión facilitada de chapas distanciadas entre ellas
 - Resultados óptimos con acero, aluminio y con cobresoldadura

- DE/**
- Sehr leichtes Schweißen auf dünnwandigen Werkstoffen
 - Geringere Materialverformung
 - Äußerst stabiler Lichtbogen auch bei geringen Stromwerten
 - Zügiges, präzises Punktschweißen
 - Voneinander entfernte Bleche lassen sich leichter zusammenfügen
 - Ausgezeichnete Ergebnisse auf Stahl, Aluminium und beim Schweißlöten

- PT/**
- Soldadura fácil em espessuras finas
 - Menor deformação do material
 - Arco extremamente estável mesmo com correntes baixas
 - Soldadura por pontos rápida e precisa
 - União facilitada de chapas distanciadas
 - Excelentes resultados em aço, alumínio e em operações de brasagem



Supermig i
Technomig 215 Dual Synergic
Technomig 225 Dual Synergic
Technomig 223 Treo Synergic
Technomig 260 Dual Synergic
Technomig Wave
Electromig Wave
Inverpuls Synergic
Inverpulse Wave

TECHNOMIG 215 - 260 DUAL SYNERGIC

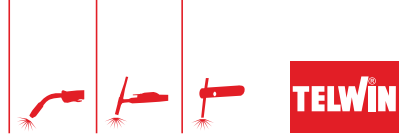

inverter

MULTIPROCESS
MIG - MMA - TIG

ONE TOUCH
LCD SYNERGY



STANDARD

- 3m MT15 mod. 215 - 742180
- 3m MT25 mod. 260 - 742183
- 0,6±0,8mm 742575
- GAS TUBE
- 3m - mod. 215 - AX25
- 3m - mod. 260 - AX50

OPTIONAL

- CONSUMABLES BOX**
MIG READY BOX F mod. 215 - 804168
- CONSUMABLES BOX**
mod. 215 - 804137
- MT25 mod. 260 - 804152

- GAS REGULATOR**
722119
- QUICK GAS CONNECTOR**
804208

- MMA - MIG/MAG TIG MASKS**
STREAM FLAME 804235
More masks pag. 84

- ALUMINIUM KIT**
802817
- STAINLESS STEEL KIT**
802037

- MIG-MAG TORCHES**
MT15 - mod. 215
4m 742181
5m 742182
MT25 - mod. 260
4m 742184
5m 742185

- ELECTRODE HOLDER**
16mm² 3m AX25 mod. 215 - 804121
25mm² 4m AX50 mod. 260 - 804123
- TIG TORCH**
4m - ST9V mod. 215 - 722563
4m - ST26V mod. 260 - 742058

- TROLLEY COSMOPOLITAN**
803079

- TROLLEY EUROPA**
803073

→ CONSUMABLES MIG-MAG Pag. 89

TECHNICAL DATA

	CODE	V _{1PH}	A _{MIN} DC	A _{MAX} 40°C DC EN 60974-1	A _{60%} 40°C DC EN 60974-1	V _{0 DC}	A _{MAX}	A _{60%}	P _{MAX}	P _{60%}	η	φ	Ø _{DC} MIN/MAX	EST	OSS	CAL	FX	BZ	IP	LxWxH cm	kg
TECHNOMIG 215 DUAL SYNERGIC	816232	230 1ph	20 - 220	180 @ 20%	100	52	31	15	5	2,2	85	0,7	1,6 3,2	0,6 1	0,8 1	0,8 1	0,8 1,2	0,8 1	IP23	62 x 26 x 49	22
TECHNOMIG 260 DUAL SYNERGIC	816056	230 1ph	20 - 250	220 @ 20%	130	60	39	22	6,3	3,3	87	0,7	1,6 4	0,6 1,2	0,8 1	0,8 1	0,8 1,2	0,8 1	IP23	62 x 26 x 49	22

EN/ MIG-MAG/FLUX/BRAZING and TIG DC-Lift inverter wire welding machines. The SYNERGIC adjustment of the welding parameters thanks to the "ONE TOUCH" technology, makes the products very easy to use. Just set the material thickness and start welding. Features: 27 (29 mod. 260) synergy curves available - visualization on LCD display of voltage, current, welding speed - regulation of: wire speed up slope, electronic reactance, burnback time, post gas - choice of 2/4 times, spot operation - polarity change for GAS MIG-MAG/BRAZING welding - thermostatic, overvoltage, undervoltage, overcurrent, motorgenerator (± 15%) protections.

IT/ Saldatrici inverter a filo MIG-MAG/FLUX/BRAZING/ MMA e TIG DC-Lift. La regolazione SINERGICA dei parametri di saldatura, grazie alla tecnologia ONE TOUCH, rende questi prodotti facili da usare. E' sufficiente regolare lo spessore del materiale per iniziare a saldare. Caratteristiche: 27 (29 mod. 260) curve sinergiche predisposte - visualizzazione su display LCD di tensione, corrente, velocità di saldatura - regolazioni: rampa di salita del filo, reattanza elettronica, tempo di bruciatura finale del filo (burn back), post gas - selezione funzionamento 2/4 tempi, spot - cambio polarità per saldatura GAS MIG-MAG/BRAZING - protezioni termostatica, sovratensione, sottotensione, sovracorrente, motogeneratore (± 15%).

FR/ Postes de soudage inverter à fil MIG-MAG/ FLUX/ BRAZING et TIG DC-Lift. Le réglage rapide SYNERGIQUE des paramètres de soudage grâce à la technologie "ONE TOUCH", rend les produits très simples à utiliser. Il suffit en effet de programmer l'épaisseur du matériel et de commencer à souder. Caractéristiques: 27 (29 mod. 260) courbes synergiques prédisposées - affichage sur écran ACL de tension, courant, vitesse de soudage - réglages: croissance de la vitesse du fil, réactance électronique, temps de brûlure finale du fil (burn-back), post gaz - sélection fonctionnement 2/4 temps, spot - changement de polarité pour soudage GAZ MIG-MAG/BRAZING - protections thermostatique, survolage, sous-voltage, surcourant, motogenerateur (±15%).

TECHNOMIG 225 DUAL SYNERGIC

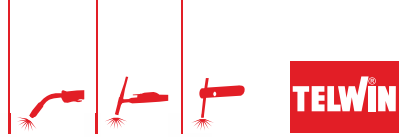

inverter

MULTIPROCESS
MIG - MMA - TIG



STANDARD

3m MT15
742180

0,6±0,8mm
742575

GAS
TUBE

3m
AX50

OPTIONAL

BOXES
MIG READY BOX F
804168

CONSUMABLES BOX
804137

GAS REGULATOR
722119

QUICK GAS
CONNECTOR
804208

MMA - MIG/MAG
TIG MASKS
STREAM FLAME
804235
More masks pag. 84

ALUMINIUM KIT
802817

MIG-MAG TORCHES
MT15
4m 742181
5m 742182

STAINLESS
STEEL KIT
802037

ELECTRODE
HOLDER
25mm² 4m AX50
804123

TIG TORCH
4m - ST26V
742058

GLOVES
MONTANA - 804336
More gloves
pag. 87

CONSUMABLES
MIG-MAG
Pag. 89

TECHNICAL DATA

CODE	V _{1PH} V (50-60Hz)	A _{MIN} DC	A _{MAX} 40°C DC	A _{60%} 40°C DC	V ₀ DC	A _{MAX}	A _{60%}	P _{MAX}	P _{60%}	η	φ	Ø _{DC} MIN/MAX	Ø _{ST}	Ø _{SS}	Ø _{AL}	Ø _{FX}	Ø _{BZ}	LxWxH cm	kg	
																				EN 60974-1 A
TECHNOMIG 225 DUAL SYNERGIC	816057	230 1ph	20 - 220	180 @ 20%	100	78	32	15	5	2,2	84	0,7	1,6 3,2	0,6 1	0,8 1	0,8 1	0,8 1,2	0,8 1	79,5 x 37,5 x 73	30

ES/ Soldadoras inverter de hilo MIG-MAG/FLUX/BRAZING y TIG DC-Lift. La rápida regulación SINÉRGICA de los parámetros de soldadura gracias a la tecnología "ONE TOUCH", vuelve el producto muy simple de usar. De hecho, es suficiente configurar el espesor del material y empezar a soldar. Características: 27 (29 mod. 260) curvas sinérgicas preparadas - visualización en display LCD de tensión, corriente, velocidad de soldadura - regulaciones: rampa de subida de hilo, reactancia electrónica, tiempo de quemado final del hilo (burn-back), post gas - selección funcionamiento 2/4 tiempos, spot - cambio de polaridad para soldadura GAS MIG-MAG/BRAZING - protecciones termostática, sobre-tensión, baja-tensión, sobre-corriente, motogenerador (± 15%).

DE/ MIG-MAG/FLUX/BRAZING und TIG DC-Lift Drahtschweißgeräte mit Invertertechnik. Durch die zügige Einstellung der SYNERGISTISCHEN Schweißparameter, dank der Technologie "ONE TOUCH", ist das Produkt äußerst bedienungsfreundlich. Einfach die Materialstärke vorgeben und los geht es mit dem Schweißen. Eigenschaften: 27 (29 mod. 260) vorgegebene Synergiekurven - Anzeige auf dem LCD-Display von Spannung, Strom und Schweißgeschwindigkeit - Einstellungen: Anstiegskennlinie für die Drahtgeschwindigkeit, elektronische Reaktanz, Nachbrenndauer des Drahtes (burn-back), Nachgasdauer - Auswahl 2/4 Taktbetrieb, Spot - Polungs-Umschaltung beim Schweißen GAS MIG-MAG/BRAZING - Schutzeinrichtungen Thermostat, Überspannung, Unterspannung, Überlastung, Stromaggregat (± 15%).

PT/ Aparelhos de soldar inverter, MIG-MAG/FLUX/BRAZING/MMA e TIG DC-Lift. O ajuste SINÉRGICO dos parâmetros de soldadura, graças à tecnologia ONE TOUCH, torna estes produtos fáceis de usar. Basta configurar a espessura do material e começar a soldar. Características: 27 (29 mod. 260) curvas sinérgicas disponíveis - Ecrã LCD para visualização de tensão, corrente, velocidade de soldadura - Regulação de: velocidade da curva de subida do fio, reatância eletrônica, burn-back time, pós-gás - Escolha de 2/4 tempos, operação por pontos - Inversão de polaridade para soldadura GAS MIG-MAG/BRAZING - Proteções termostática, sobretensão, baixa tensão, picos de corrente, motogenerador (+/- 15%).

MMA WELDING

MIG-MAG WELDING

TIG WELDING

PLASMA CUTTING

SPOT WELDING

CHARGING & STARTING

INDEX

TECHNOMIG 223 TREO SYNERGIC

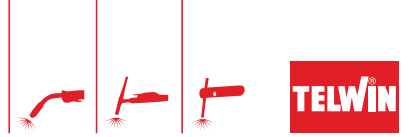

inverter

MULTIPROCESS
MIG - MMA - TIG

ONE TOUCH
LCD SYNERGY

Synergy
MMA

Advanced ATC
Thermal Control

TIG LIFT

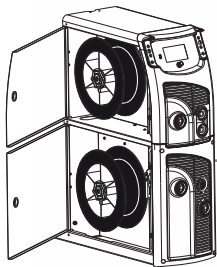

2x15kg

WIRE FEEDER
4 ROLLS

STANDARD

3m MT15 (RED)
742180
3m MT15 (BLU)
742944

SPOOL GUN M6
mod.223+M6
802407



0,6÷0,8mm
742575

0,6÷0,8mm
742576 (2x)

3m AX25



OPTIONAL

→ CONSUMABLES MIG-MAG Pag. 89

CONSUMABLES BOX
MT15
804137



ALUMINIUM KIT
802836



SPOOL GUN M6
802407



ELECTRODE HOLDER
16mm² 3m AX25
804121



GAS REGULATOR
722119 (2x)



MIG-MAG TORCHES
MT15
4m 742181
5m 742182



DOUBLE BOTTLE KIT
803067



TIG TORCH
4m - ST9V
722563



TECHNICAL DATA

	CE EAC	CODE	V _{1PH}	A _{MIN} / A _{MAX} DC	A _{MAX} 40°C DC EN 60974-1	A _{MAX} 60% 40°C DC EN 60974-1	V _{0 DC}	A _{MAX}	A _{60%}	P _{MAX}	P _{60%}	η	φ	φ _{DC} MIN/MAX	ØST	ØSS	ØAL	ØFX	ØBZ	IP	LxWxH	kg	
			V (50-60Hz)	A	A	A	V	A	A	kW	kW	%	mm	mm	mm	mm	mm	mm	mm		cm	kg	
TECHNOMIG 223 TREO SYNERGIC		816233	230	20 - 220	180 @ 20%	100	78	32	15	5	2,2	84	0,7	1,6	0,6	0,8	0,8	0,8	0,8	1	87 x 53 x 166,5	52	
TECHNOMIG 223 TREO SYNERGIC + Spool gun M6		816284	230 1ph	20 - 220	180 @ 20%	100	78	32	15	5	2,2	84	0,7	1,6	0,6	0,8	0,8	0,8	0,8	1	IP23	87 x 53 x 166,5	55

EN/ MIG-MAG/FLUX gas shielded/BRAZING/MMA/TIG DC-Lift inverter multiprocess welding machine. It allows the immediate use of three different torch types: two traditional mig torches and one spool gun. The quick SYNERGIC regulation of the welding parameters, thanks to the ONE TOUCH LCD SYNERGY technology, makes this product easy to use. The Made in Telwin ATC technology makes it easy to achieve excellent standards of welding on thin materials thanks to state-of-the-art control of the arc. Features: 17 synergy curves available - visualization on LCD display of welding parameters. Complete with 2 MIG-MAG torches, work cable and clamp.

IT/ Saldatrice inverter multiprocesso MIG-MAG/FLUX con gas/BRAZING/MMA/ TIG DC-Lift. Permette l'utilizzo immediato di tre diverse torce, due mig tradizionali ed una spool gun. La rapida regolazione SINERGICA dei parametri di saldatura, grazie alla tecnologia ONE TOUCH LCD SYNERGY, rende il prodotto molto semplice da usare. La tecnologia ATC, Made in Telwin, consente di ottenere con grande facilità eccellenti saldature su spessori sottili grazie ad un controllo avanzato dell'arco. Caratteristiche: 17 curve sinergiche predisposte - visualizzazione su display LCD dei parametri di saldatura. Completa di due torce MIG-MAG, cavo e pinza di massa.

FR/ Poste de soudage inverter, multiprocess MIG-MAG/FLUX avec gaz/BRAZING/MMA/TIG DC-Lift. Permet l'utilisation immédiate des trois différentes torches, deux mig torches traditionnelles et une spool gun. Le réglage rapide SYNERGIQUE des paramètres de soudage, grâce à la technologie ONE TOUCH LCD SYNERGY, rend le produit très simple à utiliser. La technologie ATC, Made in Telwin, permet d'obtenir avec grande facilité d'excellents soudages sur de fines épaisseurs grâce à un contrôle avancé de l'arc. Caractéristiques: 17 courbes synergiques prédisposées - affichage sur écran ACL de paramètres de soudage. Fourni avec 2 torches MIG-MAG, câble et pince de masse.

ES/ Soldadora inverter, multiproceso MIG-MAG/FLUX con gas/BRAZING/ MMA/TIG DC-Lift. Permite la utilización inmediata de tres sopletes diferentes, dos tradicionales y uno spool gun. La rápida regulación SINÉRGICA de los parámetros de soldadura gracias a la tecnología ONE TOUCH LCD SYNERGY, vuelve el producto muy simple de usar. La tecnología ATC, Made in Telwin, permite obtener con gran facilidad soldaduras excelentes en espesores sutiles, gracias a un control avanzado del arco. Características: 17 curvas sinérgicas preparadas - visualización en display LCD de los parámetros de soldadura. Equipada con 2 sopletes MIG-MAG, cable y pinza de masa.

DE/ MIG-MAG/FLUX mit Gas/LÖTEN/MMA/WIG DC-Lift multiprozess Schweißgerät, mit Invertertechnik. Jederzeit sofort mit drei Brennern einsatzbereit, nämlich zwei traditionellen MIG Brennern und einer Spoolgun. Durch die zügige, SYNERGISTISCHE Einstellung der Schweißparameter, dank der Technologie ONE TOUCH LCD SYNERGY, ist das Produkt äußerst bedienungsfreundlich. Mit der ATC-Technologie von Telwin lassen sich auf dünnwandigen Werkstoffen dank einer hochentwickelten Lichtbogensteuerung mühelos ausgezeichnete Schweißresultate erzielen. Eigenschaften: 17 vorgegebene Synergiekurven - Anzeige auf dem LCD-Display von Schweißparametern. Komplett mit 2 MIG-MAGBrennern, Masekabel und Masseklemme.

PT/ Aparelho de soldar inverter, multiproceso MIG-MAG/FLUX com gás / BRASAGEM/MMA/TIG DC-Lift. Permite a utilização imediata de tres tipos de tochas diferentes, duas tradicionais e uma spool gun. O ajuste SINÉRGICO rápido dos parâmetros de soldadura, graças a tecnologia ONE TOUCH LCD SYNERGY, torna o equipamento muito simples de utilizar. A tecnologia ATC, Made in Telwin, permite obter excelentes resultados de soldadura em materiais de espessura fina, graças ao controlo avançado do arco. Características: 17 curvas sinérgicas disponíveis - Ecrã LCD para visualização de parâmetros de soldadura. Fornecido com 2 tochas MIG-MAG, cabo e pinça.

ELECTROMIG 300 - 400 SYNERGIC

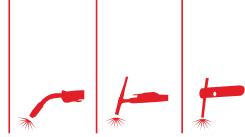

TELWIN



inverter

MULTIPROCESS
MIG - MMA - TIG

ONE TOUCH
LCD SYNERGY

Synergy
Adv.

Advanced ATC
Thermal Control

TIG LIFT

VRD
VOLTAGE REDUCTION DEVICE

WIRE FEEDER
4
ROLLS



STANDARD

3m MT25 mod. 300 - 742183	0,6÷0,8mm 742576 (2x)	
3m MT36 mod. 400 - 742186	1÷1,2mm 742366 (2x)	
GAS TUBE	3m AX50	

OPTIONAL

CONSUMABLES BOX MT25 mod. 300 - 804152	GAS REGULATOR mod. 300 722119 mod. 400 722346	MMA - MIG/MAG TIG MASKS VANTAGE RED XL 802936 More masks pag. 84	ALUMINIUM KIT mod. 300 802663 mod. 400 802273	MIG-MAG TORCHES MT25 - mod. 300 4m 742184 5m 742185 MT36 - mod. 400 4m 742187 5m 742188	ELECTRODE HOLDER 25mm ² 4m AX50 mod. 300 - 804123 35mm ² 4m AX50 mod. 400 - 804124	COIL ADAPTOR 802486
QUICK GAS CONNECTOR 804208	TIG TORCH 4m - ST26V 742058	CONSUMABLES MIG-MAG Pag. 89				

TECHNICAL DATA

CE	ERAC	CODE	V _{3PH}	A _{MIN}	A _{MAX}	A _{60%}	V _O	A _{MAX}	P _{60%}	P _{MAX}	η	φ	Ø _{DC}	Ø _{ST}	Ø _{SS}	Ø _{AL}	Ø _{FX}	Ø _{BZ}	IP	LxWxH	kg		
			V (50-60Hz)	A	EN 60974-1 40°C A	EN 60974-1 40°C A	V	A	A	kW	%	mm	mm	mm	mm	mm	mm	mm		cm	kg		
ELECTROMIG 300 SYNERGIC			816065	400 3ph	20 - 300	270 @ 30%	205	63	15	10	9	6,5	90	0,9	1,6 6	0,6 1,2	0,8 1,2	0,8 1,2	0,8 1,2	IP23	86,5 x 39 x 91,5	37	
ELECTROMIG 400 SYNERGIC			816155	230 / 400 3 ph	20 - 400 (400V)	400 @ 30%	270	73	25	15	16,5	9,5	89	0,9	1,6 8	0,6 1,6	0,8 1,6	0,8 1,6	1 1,2	0,8 1,2	IP23	86,5 x 39 x 91,5	42

EN/ Multiprocess MIG-MAG/FLUX/BRAZING/MMA and TIG DC-Lift inverter welding machines. SYNERGIC adjustment. ATC technology for welding on thin materials. Complete with torch, work clamp and cable.

FR/ Postes de soudage inverter, multiprocess MIG-MAG/FLUX/BRAZING/MMA et TIG DC-Lift. Réglage SYNERGIQUE. Technologie ATC pour soudages sur épaisseurs fines. Fournis avec torche de soudage, câble et pince de masse.

DE/ MIG-MAG/FLUX/BRAZING/MMA u. WIG DC-Lift multiprozess Schweißgeräte, mit Invertertechnik. SYNERGISTISCHE Einstellung. ATC-Technologie für Schweißen auf dünnen Werkstoffen. Komplett mit Brenner, Massekabel und Masseklemme.

IT/ Saldatrici inverter multiprocesso MIG-MAG/FLUX/BRAZING/MMA e TIG DC-Lift. Regolazione SINERGICA. Tecnologia ATC per saldature su spessori sottili. Complete di torcia, cavo e pinza di massa.

ES/ Soldadoras inverter, multiproceso MIG-MAG/FLUX/BRAZING/MMA y TIG DC-Lift. Regulación SINÉRGICA. Tecnología ATC para soldar espesores sutiles. Equipadas con soplete, cable y pinza de masa.

PT/ Aparelhos de soldar inverter, multiprocesso MIG-MAG/FLUX com gás / BRASAGEM /MMA e TIG DC-Lift. Ajuste SINÉRGICO. Tecnologia ATC para soldaduras em materiais de espessura fina. Fornecidos com tocha, cabo e pinça.

MMA WELDING

MIG-MAG WELDING

TIG WELDING

PLASMA CUTTING

SPOT WELDING

CHARGING & STARTING

INDEX

TECHNOMIG 240 WAVE

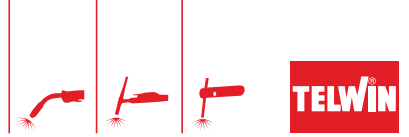

inverter

MULTIPROCESS
MIG - MMA - TIG



WATCH THE VIDEO



STANDARD

- 3m MT25 742183
- 0,6±0,8mm 742575
- GAS TUBE
- 3m AX50

OPTIONAL

CONSUMABLES BOX MT25 804152	GAS REGULATOR 722119	MMA - MIG/MAG TIG MASKS STREAM FLAME 804235 More masks pag. 84	ALUMINIUM KIT 802817	MIG-MAG TORCHES MT25 4m 742184 5m 742185 MT25 ALU (GRAY) 3m 742708	MT25 CONTROL MIG TORCH MT25 742777	ELECTRODE HOLDER 25mm² 4m AX50 804123	TROLLEY COSMOPOLITAN 803079	TROLLEY EUROPA 803073
QUICK GAS CONNECTOR 804208	PUSH PULL BOARD KIT 982219	TIG TORCH 4m - ST26V 742058						

→ CONSUMABLES MIG-MAG Pag. 89

TECHNICAL DATA

CE EAC	CODE	V _{1PH}	A _{MIN} DC	A _{MAX} 40°C DC	A _{60%} 40°C DC	V ₀ DC	A _{MAX}	A _{60%}	P _{MAX}	P _{60%}	η	φ	Ø _{DC} MIN/MAX	Ø _{ST}	Ø _{SS}	Ø _{AL}	Ø _{FX}	Ø _{BZ}	IP	LxWxH	kg
		V (50-60Hz)	A	A	A	V	A	A	kw	kw	%	mm	mm	mm	mm	mm	mm	mm	cm	cm	kg
TECHNOMIG 240 WAVE	816076	230 1ph	20 - 220	200 @ 20%	100	96	32	16	5	2,3	84	0,7	1,6 4	0,6 1	0,8 1	0,8 1,2	0,8 1,2	0,8 1	IP23	62 x 26 x 49	24

EN/ MIG-MAG/FLUX gas shielded/BRAZING/MMA and TIG DC-Lift multiprocess inverter welding machine controlled by a microprocessor. The WAVE OS system makes welding operations: customisable; traceable and analysable, by saving data via USB; simplified. Features: 55 customisable programs - continuous and pulsed functioning - user-friendly interface with TFT colour screen - WAVE OS operating system with pulsed welding programs for specific materials (AB Pulse for aluminium and galvanised sheet metal) and low thermal transfer for thin materials (ATC). Complete with torch, cable and earth clamp.

IT/ Saldatrice inverter multiprocesso MIG-MAG/FLUX con gas/BRAZING/MMA/ TIG DC-LIFT controllata a microprocessore. Il sistema WAVE OS rende le operazioni di saldatura personalizzabili; tracciabili e analizzabili attraverso il salvataggio dei dati via USB; semplificate. Caratteristiche: 55 programmi personalizzabili - funzionamento continuo e in pulsato - interfaccia user-friendly con schermo TFT a colori - sistema operativo Wave OS con programmi di saldatura in pulsato per materiali specifici (AB Pulse per alluminio e lamiera galvanizzate) e a basso apporto termico per spessori sottili (ATC). Completa di torcia, cavo e pinza di massa.

FR/ Poste de soudage inverter multiprocessus MIG-MAG/FLUX avec gaz/BRAZING/MMA et TIG DC-Lift contrôlé par microprocesseur. Le système WAVE OS rend les opérations de soudage: personnalisables; traçables et analysables, grâce à l'enregistrement des données sur USB; simplifiées. Caractéristiques: 55 programmes personnalisables - fonctionnement continu et en pulsé - interface conviviale avec écran TFT en couleurs - système opérationnel Wave OS avec programmes de soudage en pulsé pour matériaux spécifiques (AB Pulse pour aluminium et tôles galvanisées) et à faible apport thermique pour des épaisseurs fines (ATC). Fourni avec torche, câble et pince de masse.

ES/ Soldadora inverter multiproceso MIG-MAG/FLUX con gas/ BRAZING/ MMA y TIG DC-Lift controlada por microprocesador. El sistema WAVE OS hace que las operaciones de soldadura: se puedan personalizar; se puedan trazar y analizar, guardando los datos por USB; se simplifiquen. Características: 55 programas personalizables - funcionamiento continuo y en pulsado - interfaz fácil de usar con pantalla TFT de colores - sistema operativo Wave OS con programas de soldadura en pulsado para materiales específicos (AB Pulse para aluminio y chapas galvanizadas) y de baja aportación térmica para espesores finos (ATC). Incluye antorcha, cable y pinza de masa.

DE/ Mehrprozess-Schweißmaschine mit Invertertechnik mit MIG-MAG/FLUX mit Gas/BRAZING/MMA und WIG DC-Lift mit Mikroprozessorsteuerung. Schweißverfahren mit dem System WAVE OS: individuell einstellbar; rückverfolgbar und analysierbar mittels Datenabspeicherung über USB; vereinfacht. Eigenschaften: 55 individuell erstellbare Programme - Kontinuierlicher und pulsierter Betrieb - Benutzerfreundlicher TFT-Bildschirm mit Farbdisplay - Betriebssystem Wave OS mit Schweißprogrammen im pulsierten Betrieb für spezielle Werkstoffe (AB Pulse für Aluminium und galvanisierte Bleche) und mit geringer Wärmezufuhr bei dünnen Dicken (ATC). Brenner, Massekabel und Masseklemme sind enthalten.

PT/ Aparelho de soldar inverter, multiprocesso MIG-MAG/FLUX com gás / BRASAGEM /MMA e TIG DC-Lift controlado por microprocessador. O sistema WAVE OS permite a personalização das operações de soldadura; possibilita a localização e análise através do armazenamento de dados via USB; simplificadas. Características: 55 programas personalizáveis - funcionamento contínuo e pulsado - interface fácil de utilizar com ecrã TFT a cores - sistema operativo Wave OS com programas de soldadura pulsada para materiais específicos (AB Pulse para alumínio e chapas galvanizadas) e de baixa transferência térmica para espessuras finas (ATC). Inclui tocha, cabo e pinça.

PULSED FOR ALUMINIUM AND GALVANISED SHEET METAL

EN/ In the automotive sector, vehicles are designed to always guarantee the best performance and less consumption also thanks to use of materials such as aluminium and steel with various compositions. Welding of these materials must guarantee high mechanical and aesthetic standards, required and defined by the car manufacturers. The solution to these needs is pulse and dual pulse welding that allows high speed execution, excellent cleaning and penetration, low deformation and welding in all positions, especially with aluminium, steel and alloys.

IT/ Nel settore automotive i veicoli sono progettati per garantire sempre maggiori prestazioni e minori consumi anche grazie all'impiego di materiali come alluminio e acciai con diverse composizioni. La saldatura di questi materiali deve garantire elevati standard meccanici ed estetici, richiesti e definiti dalle stesse case automobilistiche. La soluzione a queste necessità è la saldatura in pulsato e doppio pulsato che consente alta velocità di esecuzione, ottima pulizia e penetrazione, bassa deformazione, saldatura in tutte le posizioni specialmente con alluminio, acciaio e leghe.

FR/ Dans le secteur de l'automobile, les véhicules sont conçus pour garantir des performances toujours meilleures et des consommations minimales grâce aussi à l'utilisation de matériaux comme l'aluminium et des aciers de diverses compositions. Le soudage de ces matériaux doit garantir de hauts standards mécaniques et esthétiques, exigés et définis par ces mêmes constructeurs d'automobiles. La réponse à ces exigences est le soudage en pulsé et double pulsé qui permet une haute vitesse d'exécution, un nettoyage et une pénétration optimale, une faible déformation, un soudage dans toutes les positions notamment avec l'aluminium, l'acier et les alliages.

ES/ En el sector de la automoción los vehículos se diseñan para garantizar prestaciones cada vez más elevadas y menores consumos, gracias también a la utilización de materiales como el aluminio y aceros con diferentes composiciones. La soldadura de estos materiales debe garantizar elevados estándares mecánicos y estéticos, necesarios y definidos por las mismas empresas de automoción. La solución a estas necesidades es la soldadura en pulsado y doble pulsado que permite una elevada velocidad de ejecución, óptima limpieza y penetración, baja deformación, soldadura en todas las posiciones especialmente con aluminio, aceros y aleaciones.

DE/ Die Fahrzeugentwicklung im Automotive-Bereich erfolgt so, dass immer die besten Leistungen und der geringste Verbrauch garantiert werden, auch dank des Einsatzes von Werkstoffen wie Aluminium und Stählen verschiedener Zusammensetzungen. Das Schweißen dieser Werkstoffe muss erhöhte mechanische und ästhetische Standards sicherstellen, die von denselben Automobilherstellern angefragt und festgelegt werden. Die Lösung hierfür heißt Impuls- und Doppel-Impulsschweißen. Es werden eine hohe Ausführungsgeschwindigkeit, optimale Reinigung und ausgezeichnetes Eindringen, geringe Verformung und Schweißen in allen Lagen vor allem von Aluminium, Stahl und Legierungen ermöglicht.

PT/ No sector automóvel, os veículos são concebidos para um maior desempenho e um menor consumo de combustível também graças à utilização de materiais como o alumínio e os aços com diferentes composições. A soldadura destes materiais deve garantir elevados padrões mecânicos e estéticos, exigidos e definidos pelos próprios fabricantes de automóveis. A solução para estas necessidades é soldadura pulsada e dupla pulsação, o que permite alta velocidade de execução, excelente limpeza e penetração, baixa deformação, soldadura em todas as posições, especialmente com alumínio, aço e ligas.

AB PULSE & AB POP



EN/ AB Pulse and AB PoP are the state-of-the-art technological solutions developed by Telwin for applications on aluminium and galvanized metal sheets. The idea of generating waveforms, optimised for the welding of materials which are particularly sensitive to heat transfer, guarantees excellent results, from both a structural and aesthetic viewpoint, comparable to those achieved by TIG welding.

IT/ AB Pulse e AB PoP sono soluzioni tecnologiche all'avanguardia sviluppate da Telwin per le applicazioni su alluminio e lamiera galvanizzate. L'ideazione di forme d'onda ottimizzate per la saldatura di materiali particolarmente sensibili all'apporto termico, assicura eccellenti risultati sia dal punto di vista strutturale che estetico, paragonabili a quelli della saldatura TIG.

FR/ AB Pulse et AB PoP sont des solutions technologiques à l'avant-garde développées par Telwin pour les applications sur l'aluminium et les tôles galvanisées. L'idéation de formes d'onde optimisées pour le soudage de matériaux particulièrement sensibles à l'apport thermique assure d'excellents résultats aussi bien du point de vue structurel que du point de vue esthétique, comparables aux résultats du soudage TIG.

ES/ AB Pulse y AB PoP son soluciones tecnológicas de vanguardia desarrolladas por Telwin para las aplicaciones en aluminio y chapas cincadas. El diseño de formas de onda optimizadas para la soldadura de materiales especialmente sensibles al aporte térmico asegura excelentes resultados tanto desde el punto de vista estructural como estético, paragonables a los de la soldadura TIG.

DE/ AB Pulse und AB PoP sind wegweisende technische Lösungen, die Telwin für Anwendungen auf Aluminium und galvanisierten Blechen entwickelt hat. Die Schaffung optimierter Wellenformen für das Schweißen besonders empfindlich auf Wärmeeintrag reagierender Werkstoffe stellt hinsichtlich Festigkeit und Optik exzellente Resultate sicher, die sich mit denen des WIG Schweißens vergleichen lassen.

PT/ AB Pulse e AB PoP são soluções tecnológicas de vanguarda desenvolvidas pela Telwin para aplicações em alumínio e chapas galvanizadas. A concepção de formas de onda optimizadas para soldadura de materiais particularmente sensíveis ao calor assegura excelentes resultados tanto em termos estruturais como estéticos, comparáveis à soldadura TIG.



CuSi₃ - Brazing

Aluminium

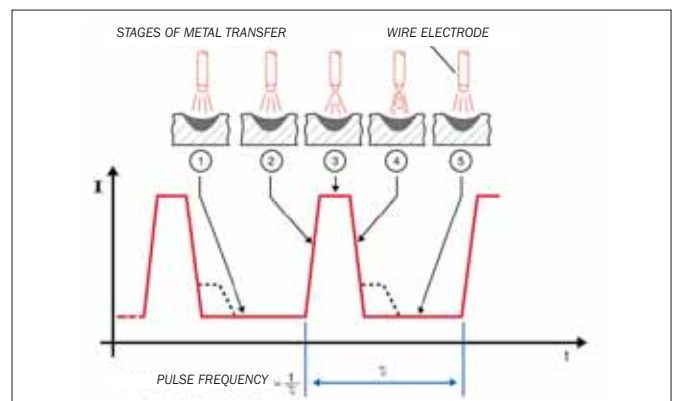

TECHNOMIG 243 WAVE

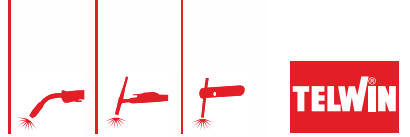

BODYSHOP

inverter

MULTIPROCESS
MIG - MMA - TIG



TIG
LIFT

USB

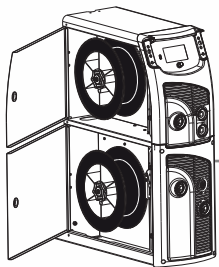

2x15kg

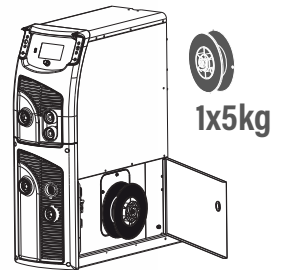

1x5kg

APPROVED
by

GM General Motors



EN/ Microprocessor controlled MIG-MAG/FLUX gas shielded/BRAZING/MMA/TIG DC-Lift inverter multiprocess welding machine. It is particularly suitable for use in body shops and allows the immediate use of three different torches. This feature enables the user to work directly on different materials without any need to change either the torch or the wire spool (3 coil storage: 1/ 5 kg max and 2/15kg max). Features: 55 customisable programs - continuous and pulsed functioning - 3 torches always ready for use - user-friendly interface with TFT colour screen - WAVE OS operating system with pulsed welding programs for specific materials (AB Pulse for aluminium and galvanised sheet metal) and low thermal transfer for thin materials (ATC). Complete with 2 MT15 torches, 1 MT25 torch, cable and earth clamp.

IT/ Saldatrice inverter multiprocesso MIG-MAG/FLUX con gas/BRAZING/MMA/TIG DC-LIFT controllata a microprocessore. E' particolarmente indicata in carrozzeria e permette l'utilizzo immediato di tre diverse torce. Questa caratteristica consente l'intervento diretto su diversi materiali senza effettuare cambi torce e bobine filo (3 vani bobine: 1/ 5 kg max e 2/15kg max). Caratteristiche: 55 programmi personalizzabili - funzionamento continuo e in pulso - 3 torce sempre pronte all'uso - interfaccia user-friendly con schermo TFT a colori - sistema operativo Wave OS con programmi di saldatura in pulso per materiali specifici (AB Pulse per alluminio e lamiere galvanizzate) e a basso apporto termico per spessori sottili (ATC). Completa di 2 torce MT15, 1 torcia MT25, cavo e pinza di massa.

FR/ Poste de soudage inverter, multiprocess MIG-MAG/FLUX avec gaz/BRAZING/MMA/TIG DC-Lift contrôlé par microprocesseur. Particulièrement prévu pour les applications de carrosserie, permet l'utilisation immédiate des trois différentes torches. Cette caractéristique permet une intervention directe sur différents matériaux sans besoin de remplacer torche et bobine de fil (3 lieux bobines: 1/5 kg max et 2/15kg max). Caractéristiques: 55 programmes personnalisables - fonctionnement continu et en pulsé - 3 torches toujours prêtes à l'usage - interface conviviale avec écran TFT en couleurs - système opérationnel Wave OS avec programmes de soudage en pulsé pour matériaux spécifiques (AB Pulse pour aluminium et tôles galvanisées) et à faible apport thermique pour des épaisseurs fines (ATC). Fourni avec 2 torches MT15, 1 torche MT25, câble et pince de masse.



TECHNICAL DATA

CE EAC	CODE	V _{1PH} V (50-60Hz)	A _{MIN} A _{MAX} DC	A _{MAX} 40°C DC	A _{60%} 40°C DC	V _O DC	A _{MAX}	A _{60%}	P _{MAX}	P _{60%}	η	φ	Ø _{MIN/MAX} DC	EST	ESS	CAL	CFX	CBZ	IP	LxWxH cm	kg
● TECHNOMIG 243 WAVE	816066	230 1ph	20 - 220	180 @ 20%	100	96	32	16	5	2,3	84	0,7	1,6 - 4	0,6 - 1	0,8 - 1	0,8 - 1,2	0,8 - 1,2	0,8 - 1	IP23	87 x 53 x 166,5	59

TECHNOMIG 243 WAVE

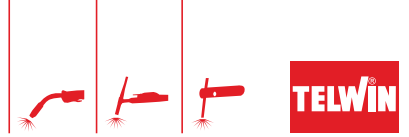

ES/ Soldadora inverter, multiproceso MIG-MAG/FLUX con gas/BRAZING/ MMA/TIG DC-Lift controlada con microprocesador. Está especialmente indicada en carrocería y permite la utilización inmediata de tres sopletes diferentes. Esta característica permite la intervención directa en diferentes materiales sin efectuar cambios de sopletes de bobinas de hilo (3 lugar bobinas: 1/5 kg max y 2/15kg max). Características: 55 programas personalizables - funcionamiento continuo y en pulsado - 3 antorchas siempre preparadas para el uso - interfaz fácil de usar con pantalla TFT de colores - sistema operativo Wave OS con programas de soldadura en pulsado para materiales específicos (AB Pulse para aluminio y chapas galvanizadas) y de baja aportación térmica para espesores finos (ATC). Incluye 2 antorchas MT15, 1 antorcha MT25, cable y pinza de masa.

DE/ Mikroprozessorgesteuertes, MIG-MAG/FLUX mit Gas/LÖTEN/MMA/WIG DC-Lift mltiprozess Schweißgerät, mit Invertertechnik. Besonders für Anwendungen im Karosseriebau geeignet und jederzeit sofort mit drei Brennern einsatzbereit; dadurch können ohne Wechsel des Brenners und der Drahtspule verschiedene Werkstoffe bearbeitet werden, (3 Spulelager: 1/5 kg max und 2/15kg max). J Eigenschaften: 55 individuell erstellbare Programme - Kontinuierlicher und pulsierter Betrieb - 3 Brenner immer einsatzbereit - Benutzerfreundlicher TFT-Bildschirm mit Farbdisplay - Betriebssystem Wave OS mit Schweißprogrammen im pulsierten Betrieb für spezielle Werkstoffe (AB Pulse für Aluminium und galvanisierte Bleche) und mit geringer Wärmezufuhr bei dünnen Dicken (ATC). Zwei MT15 Brenner, ein MT25 Brenner, Massekabel und Masseklemme sind enthalten.

PT/ Aparelho de soldar inverter, multiprocesso MIG-MAG/FLUX com gás / BRASAGEM/MMA/TIG DC-Lift controlado por microprocessador. Particularmente adequado para trabalhos em carroceria, permite a utilização imediata de tres tipos de tochas diferentes. Esta característica permite a intervenção direta em diferentes materiais sem efetuar trocas de tochas ou bobinas de fio (espaco para 3 bobinas: 1/5 kg max. e 2/15kg max.). Características: 55 programas personalizáveis - funcionamento continuo e pulsado - 3 tochas sempre preparadas para utilizar - interface fácil de utilizar com ecrã TFT a cores - sistema operativo Wave OS com programas de soldadura pulsada para materiais específicos (AB Pulse para aluminio e chapas galvanizadas) e de baixa transferencia termica para espessuras finas (ATC). Fornecido com 2 tochas MT15, 1 tocha MT25, cabo e pinça.

TECHNOMIG 243 PACK ACCESSORIES - 852170

COMPLETE WITH



VANTAGE RED XL
MMA/MIG-MAG/TIG HELMET
802936

- automatic
- variable: 4/5÷9/9÷13 DIN
- double range
- grinding mode
- TIG from >2A
- class: 1/1/1/2
- 4 sensors
- XL view area
- true color



CONSUMABLES BOX

FOR MIG TORCH MT15
804137



MT15

- contact tip Ø 0.6 mm
- contact tip Ø 0.8 mm Fe
- contact tip Ø 0.8 Al
- conical nozzle
- gas diffusor
- nozzle spring

CONSUMABLES BOX

FOR MIG TORCH MT25
804152



MT25

- contact tip Ø 1 mm Al
- contact tip Ø 0.8 mm
- contact tip Ø 1 mm Fe
- conical nozzle MT25
- gas diffusor MT25
- nozzle spring MT25

GAS REGULATOR
2 MANOMETERS 12 L/MIN
722119



2x

AlMg₅ WIRE COIL
1.0 MM 2 KG
804069



STEEL WIRE COIL
0,8 MM 5 KG
802396



BRAZING WIRE COIL
Cu/Si₃ 0,8 MM 3 KG
802434



HEAT RESISTANT BLANKET
1100°C
1500x1900 mm
802679



STANDARD

3m MT15 742180 (RED) 3m MT15 742944 (BLUE) 3m MT25 ALU 742708 (GRAY)



0,6÷0,8mm 742575 (x2) 0,6÷0,8mm 742576 (x2) 1-1,2mm (Al) 722167 (x2)

3m AX50

OPTIONAL

CONSUMABLES BOX
MIG TORCH MT15
804137

MIG TORCH MT25
804152



GAS REGULATOR
722119(x2)



QUICK GAS CONNECTOR
804208



MMA - MIG/MAG TIG MASKS
VANTAGE RED XL 802936
More masks pag. 84



ALUMINIUM KIT
802663



MT25 CONTROL MIG TORCH
MT25 742777



PUSH PULL BOARD KIT
982219



DOUBLE BOTTLE KIT
803067



ELECTRODE HOLDER
804123



TIG TORCH
4m - ST26V 742058



CONSUMABLES MIG-MAG
Pag. 89



WELDING ADVANCED VISUAL ENVIRONMENT

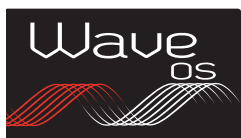

EASY: JUST CHOOSE THICKNESS AND WELD IN PULSE!

WELDING PARAMETERS

DISPLAY OF THE PROGRAM IN USE

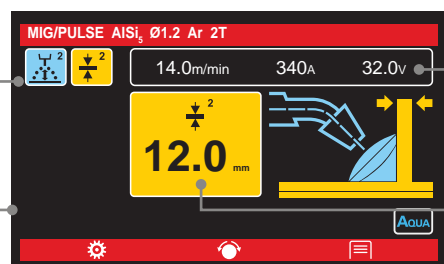

VISUALISATION OF MAIN PARAMETERS DURING WELDING

MATERIAL THICKNESS SETTING

ADVANCED THERMAL CONTROL



FOR THIN THICKNESSES

AB PULSE & AB POP

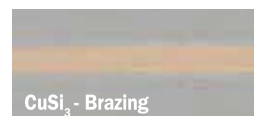

PULSED & DOUBLE PULSED FOR ALUMINIUM & CuSi₃

MMA WELDING

MIG-MAG WELDING

TIG WELDING

PLASMA CUTTING

SPOT WELDING

CHARGING & STARTING

INDEX



Wave OS is designed to turn welding into a totally unique experience, customised to suit the individual needs of operators.



INTELLIGENCE

A BRAND NEW WELDING CONCEPT

EN/ A high-tech system that redesigns the manual welding process to improve quality, ensure repeatability and boost efficiency.

IT/ INTELLIGENZA: Un sistema high-tech che ripensa il processo di saldatura manuale per migliorare la qualità, assicurare la ripetibilità, aumentare l'efficienza.

FR/ INTELLIGENCE: Un système high-tech qui repense le processus de soudage manuel pour améliorer la qualité, assurer la répétabilité, augmenter l'efficacité.

ES/ INTELIGENCIA: Un sistema high-tech que reconsidera el proceso de soldadura manual para mejorar la calidad, asegurar la repetibilidad, aumentar la eficiencia.

DE/ INTELLIGENZ: Ein Hightech-System mit neu konzipiertem manuellem Schweißvorgang, der die Qualität verbessert, die Wiederholbarkeit gewährleistet und die Effizienz erhöht.

PT/ INTELIGÊNCIA: Um sistema high-tech que redefine o processo de soldadura manual para melhorar a qualidade, garantir a repetibilidade e aumentar a eficiência.

INTERACTION

A NEW WAY OF COMMUNICATING

EN/ Wave OS simplifies man-machine interaction and guarantees complete customisation of the work environment.

IT/ INTERAZIONE: Wave OS semplifica l'interazione uomo-macchina e garantisce una totale personalizzazione dell'ambiente di lavoro.

FR/ INTERACTION: Wave OS simplifie l'interaction homme-machine et garantit une totale personnalisation du milieu de travail.

ES/ INTERACCIÓN: Wave OS simplifica la interacción hombre-máquina y garantiza una total personalización del ambiente de trabajo.

DE/ INTERAKTION: Wave OS vereinfacht das Wechselspiel zwischen Mensch und Maschine und gestattet eine völlig individuelle Gestaltung der Arbeitsumgebung.

PT/ Wave OS foi concebida para fazer da soldadura uma experiência única, à medida das necessidades do operador.



EXPERT MODE



EASY MODE

EFFICIENCY

RESPONDING TO EVERY DAY CHALLENGES

EN/ Wave OS is the perfect solution to respond to the every day demands for competitiveness and productivity. Nowadays, quality and repeatability are fundamental and essential requisites. The response to such challenges starts with Wave OS.

IT/ EFFICIENZA: Wave OS è la soluzione alle richieste di competitività e produttività di ogni giorno. La qualità e la sua ripetibilità sono ormai requisiti imprescindibili. La risposta a queste sfide inizia con Wave OS.

FR/ EFFICACITÉ: Wave OS est la solution aux demandes de compétitivité et de productivité de chaque jour. La qualité et sa répétabilité sont désormais des conditions essentielles incontournables. La réponse à ces défis commence avec Wave OS.

ES/ EFICIENCIA: Wave OS es la solución a las necesidades de competitividad y productividad del día a día. La calidad y la repetibilidad de la misma son actualmente requisitos imprescindibles. La respuesta a estos desafíos comienza con Wave OS.

DE/ EFFIZIENZ: Wave OS ist die Lösung für die Anforderungen, die Tag für Tag an Wettbewerbsfähigkeit und Produktivität gestellt werden. Die Güte und ihre Wiederholbarkeit sind mittlerweile unabdingbare Voraussetzungen. Die Antwort auf diese Herausforderungen beginnt mit Wave OS.

PT/ EFICIÊNCIA: Wave OS é a solução perfeita para responder às necessidades de competitividade e produtividade diárias. A qualidade e repetibilidade são atualmente requisitos imprescindíveis. A resposta a estes desafios começa com Wave OS.

KNOWLEDGE

KNOWLEDGE IS THE CORE PRINCIPLE OF IMPROVEMENT

EN/ Wave OS is an exceptionally powerful knowledge tool designed to trace, analyse and control production processes thus granting comprehensive monitoring of operating parameters.

IT/ CONOSCENZA: Wave OS è un potente strumento di conoscenza in grado di tracciare, analizzare e controllare i processi produttivi garantendo il completo monitoraggio dei parametri nelle lavorazioni.

FR/ CONNAISSANCE: Wave OS est un instrument de connaissance puissant en mesure de tracer, analyser et donc contrôler les processus de production et garantir la surveillance complète des paramètres dans les usinages.

ES/ CONOCIMIENTO: Wave OS es un potente instrumento de conocimiento capaz de trazar, analizar y por lo tanto controlar los procesos productivos y garantiza el completo seguimiento de los parámetros en las elaboraciones.

DE/ WISSEN: Wave OS ist ein leistungsstarkes Wissensinstrument, das in der Lage ist, die Fertigungsprozesse aufzuzeichnen, zu analysieren und anschließend zu kontrollieren. Es ermöglicht die vollständige Überwachung der Bearbeitungsparameter.

PT/ CONHECIMENTO: Wave OS é um potente instrumento de conhecimento capaz de localizar, analisar e controlar os processos de produção muito além dos limites até agora estabelecidos.

WELDING DATA MANAGEMENT

THE COST AND PERFORMANCES CONTROL TOOL

EN/ Welding Data Management is an intuitive programme conceived to facilitate you in cost management, increase processing quality and support professional welders' tests, etc.

IT/ Welding Data Management è un programma dall'utilizzo intuitivo ideato per facilitarti nella gestione dei costi, nel miglioramento della qualità delle lavorazioni, nel supporto ai test per saldatori qualificati, etc.

FR/ Welding Data Management est un programme à l'utilisation intuitive conçu pour vous aider dans la gestion des coûts, dans l'amélioration de la qualité des usinages, dans le support aux tests pour soudeurs qualifiés, etc.

ES/ Welding Data Management es un programa con una utilización intuitiva ideado para facilitar la gestión de los costes, la mejora de la calidad de las elaboraciones, la asistencia en las pruebas para soldadores cualificados, etc.

DE/ Welding Data Management ein intuitives Anwendungsprogramm, das entwickelt wurde, um Ihnen u. a. beim Kostenmanagement, bei der Verbesserung der Bearbeitungsqualität und beim Support für Tests von qualifizierten Schweißern Erleichterung zu bringen.

PT/ Welding Data Management (a Gestão de Dados de Soldadura) é um programa intuitivo de utilização concebido para o ajudar a gerir os custos, melhorar a qualidade do trabalho, apoiar testes para soldadores qualificados, etc.

ELECTROMIG 230 WAVE - 330 WAVE AQUA

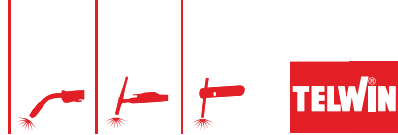

inverter

MULTIPROCESS
MIG - MMA - TIG



ELECTROMIG 230 WAVE
816060



STANDARD

3m MT25 mod. 230, 330 742183	0,6-0,8mm mod. 230 - 742575 mod. 330 - 742576 (2x)
3m AQUA MT500 mod. 330 AQUA 722625	1-1,2mm mod. 330 - 742322 (2x)
GAS TUBE	G.R.A. 3300 mod. 330 AQUA 802942
	3m AX50

OPTIONAL

CONSUMABLES BOX MT25 804152	GAS REGULATOR 722346	ALUMINIUM KIT mod. 230 802817 mod. 330 802663 mod. 330 AQUA 802409	MIG-MAG TORCHES MT25 mod. 230, 330 4m 742184 5m 742185 MT500 mod. 330 AQUA 3m 722625 4m 742821 5m 722683	MT25 CONTROL MIG TORCH MT25 742777	PUSH PULL BOARD KIT 982219	ELECTRODE HOLDER 25mm ² 4m AX50 804123	COOLANT FOR COOLING SYSTEMS mod. 330 AQUA 5L 802976
	QUICK GAS CONNECTOR 804208			SPOOL GUN M6 802407	COIL ADAPTOR 802486	TIG TORCH 4m - ST26V 742058	G.R.A. 3300 mod. 330 802942

→ CONSUMABLES MIG-MAG Pag. 89

TECHNICAL DATA

CE EAC	CODE	V _{3PH}	A _{MIN} / A _{MAX} DC	A _{MAX} 40°C DC	A _{MAX} 60°C DC	V ₀ DC	A _{MAX} 60%	A _{60%}	P _{MAX}	P _{60%}	η	φ	Ø _{MIN} / Ø _{MAX} DC	Ø _{ST}	Ø _{SS}	Ø _{AL}	Ø _{FX}	Ø _{BZ}	IP	LxWxH	kg
		V (50-60Hz)	A	A	A	V	A	A	kW	kW	%	mm	mm	mm	mm	mm	mm	mm	mm	cm	kg
ELECTROMIG 230 WAVE	816060	400 3ph	10 - 240	200 @ 20%	105	95	9	5,5	5,5	3	86	0,8	1,6 / 4	0,6 / 1	0,8 / 1	0,8 / 1	0,8 / 1,2	0,8 / 1	IP23	79,5 x 37,5 x 73	32
ELECTROMIG 330 WAVE	816061	400 3ph	20 - 300	270 @ 30%	205	63	15	10	9	6,5	90	0,9	1,6 / 6	0,6 / 1,2	0,8 / 1,2	0,8 / 1,2	0,8 / 1,2	0,8 / 1,2	IP23	86,5 x 39 x 91,5	39

ELECTROMIG 330 WAVE AQUA - 816062 49 kg

EN/ Multiprocess MIG-MAG (continuous and pulse), FLUX gas shielded/BRAZING/MMA/TIG DC-Lift inverter welding machines. Welding processes having low thermal transfer, ROOT-MIG and ATC, and specific processes for aluminium and brazed materials AB PULSE and AB PoP. Complete with MIG-MAG torch, cable and earth clamp.

FR/ Postes de soudage à inverter, avec fonctionnement continu et pulsé, multiprocessus MIG-MAG/FLUX avec gaz / BRASAGE/MMA/TIG DC-Lift. Processus de soudage à bas apport thermique, ROOT-MIG et ATC, et spécifiques pour aluminium et braso-soudés AB PULSE et AB PoP. Fournis avec torche de soudage MIG-MAG, câble et pince de masse.

DE/ Schweißmaschinen mit Invertertechnik, kontinuierlicher und pulsierter Betrieb, diverse Verfahren MIG-MAG/FLUX mit Gas/BRAZING/MMA/WIG DC-Lift. Schweißverfahren bei geringer Wärmezufuhr mit ROOT-MIG und ATC, sowie speziell für Aluminium und zum Schweißlöten mit AB PULSE und AB PoP Verfahren werden. Enthalten sind der MIG-MAG Brenner, das Massekabel sowie die Masseklemme.

IT/ Saldatrici inverter, con funzionamento continuo e pulsato, multiprocesso MIG-MAG/FLUX con gas / BRAZING/ MMA/TIG DC-Lift. Processi di saldatura a basso apporto termico, ROOT-MIG e ATC, e specifici per alluminio e saldo-brasatura AB PULSE e AB PoP. Complete di torcia MIG-MAG, cavo e pinza di massa.

ES/ Soldadoras inverter, con funcionamiento continuo y a impulsos, multiproceso, MIG-MAG/FLUX con gas/ BRAZING/ TIG DC-Lift. Procesos de soldadura de bajo aporte térmico, ROOT-MIG y ATC, y específicos para aluminio y cobresoldadura AB PULSE y AB PoP. Equipadas con antorcha MIG-MAG, cable y pinza de masa

PT/ Aparelhos de soldar inverter, multiprocesso MIG-MAG/FLUX com gás/BRASAGEM/MMA/TIG DC-Lift, com funcionamento contínuo e pulsado. Processos de soldadura específicos com baixa transferência térmica, ROOT-MIG e ATC, e processos específicos para alumínio e materiais brasados AB PULSE e AB PoP. Fornecidos com tocha MIG-MAG, cabo e pinça.

MMA WELDING

MIG-MAG WELDING

TIG WELDING

PLASMA CUTTING

SPOT WELDING

CHARGING & STARTING

INDEX

TECHNOLOGY PLASMA 41 XT - 54 XT KOMPRESSOR



XT

inverter



DOWNLOAD LEAFLET



STANDARD

4m PH

mod. 41 XT - 804155

4m PK

mod. 54 XT - 804156

AIR PRESSURE

REGULATOR

mod. 41 XT - 125237

3m AX25



OPTIONAL

PH TORCH CONSUMABLES BOX mod. 41 XT 804415



CONTENT					
802420 6pcs	802422 2pcs	804418 3pcs	EXTENDED		
			802428 2pcs	802429 2pcs	

PKTORCH CONSUMABLES BOX mod. 54 XT k 804416



CONTENT					
802420 6pcs	802422 2pcs	804418 3pcs	EXTENDED		
			802428 2pcs	802429 2pcs	

CIRCULAR CUTTING UNIT Ø max 680mm 804169



MMS-10 MOISTURE & MIXTURE STOP FILTER mod. 41 XT 804340



MMS-10 AIR FILTER CARTRIDGES (4pcs) mod. 41 XT 804343



→ CONSUMABLES: PLASMA Pag. 90

TECHNICAL DATA



	CODE	V _{1PH} V (50-60Hz)	A _{MIN} A	A _{MAX} 40°C EN 60974-1 A	V ₀ V	A _{MAX} A	P _{MAX} kW	η %	φ mm	↓ l/min	↓ bar	IP	LxWxH cm	kg	
TECHNOLOGY PLASMA 41 XT	816146	230 1ph	10 - 40	35 @ 30 %	313	25	4	16	85	0,7	15	100	4 - 5	IP23 47,5 x 18,2 x 29,2	9
TECHNOLOGY PLASMA 54 XT KOMPRESSOR	816147	230 1ph	10 - 40	35 @ 30 %	313	27,5	4,5	16	82	0,7	12	-	-	IP23 47 x 26 x 37,8	17,8

EN/ Inverter, compressed air plasma cutting systems, with contact striking of pilot arc. Allow a rapid, distortion-proof cutting of all conductive materials such as steel, stainless steel, galvanized steel, aluminium, copper, brass, etc. Model 54XT has a built-in compressor. Features: robust and impact resistant - warning led for torch under voltage, protections - warning led for consumables change - torch automatic cooling - visualization of air pressure - thermostatic, overvoltage, undervoltage, overcurrent protections. Complete with torch.

IT/ Sistemi inverter di taglio al plasma ad aria compressa, con innesco a contatto dell'arco pilota. Consentono il taglio veloce senza deformazione di tutti i materiali conduttori quali acciaio, acciaio inox, acciaio galvanizzato, alluminio, rame, ottone, ecc. Il modello 54XT è munito di compressore. Caratteristiche: robusti e resistenti agli urti - segnalazione presenza tensione in torcia, protezioni - segnalazione cambio consumabili - raffreddamento automatico della torcia - visualizzazione pressione aria - protezioni termostatica, sovratensione, sottotensione, sovracorrente. Completati di torcia.

FR/ Systèmes inverter de découpage au plasma à air comprimé avec amorçage de l'arc pilote à contact. Permettent un découpage rapide et sans déformations de tous les matériaux conducteurs tels que acier, acier inox, acier galvanisé, aluminium, cuivre, laiton, etc. Le modèle 54XT est équipé d'un compresseur. Caractéristiques : robuste et résistant aux chocs - signalisation présence tension torche, protections - led d'avertissement pour le remplacement des consommables - refroidissement automatique torche - signalisation pression air - protections thermostatique, survoltage, sous-voltage, surcourant. Fournis avec torche.

ES/ Sistemas inverter de corte por plasma con aire comprimido, con encendido por contacto del arco piloto. Permiten cortar rápidamente y sin deformaciones todos los materiales conductores como acero, acero inoxidable, acero galvanizado, aluminio, cobre, latón, etc. El modelo 54XT está provisto de compresor. Características: robusto y resistente al impacto - señalación presencia de tensión en soplete, protecciones - señalación para la sustitución de consumibles - enfriamiento automático antorcha - visualización presión aire - protecciones termostática, sobretensión, baja-tensión, sobre-corriente. Equipados con antorcha.

DE/ Invertersysteme für das Druckluft-Plasmaschneiden mit Kontaktzündung des Pilotlichtbogens. Zum schnellen, verformungsfreien Schneiden aller leitenden Werkstoffe wie Stahl, Edelstahl, verzinktem Stahl, Aluminium, Kupfer, Messing, usw. Das Modell 54XT ist mit einem Kompressor ausgestattet. Eigenschaften: robust und schlagfest - Anzeigen Brennerspannung, Schutzrichtungen - Signalisierung für Verbrauchsmaterialwechsel - automatische Kühlung des Brenners - Druckluftanzeige - Schutzrichtungen Thermostat, Überspannung, Unterspannung, Überlastung. Komplett mit Brenner.

PT/ Sistemas inverter de corte por jato plasma com ar comprimido, com início por contacto do arco piloto. Permitem um corte rápido, sem deformações, de todos os materiais condutores como aço, aço inoxidável, aço galvanizado, alumínio, cobre, latão, etc. O modelo 54XT está equipado com um compressor. Características: robustos e resistentes aos impactos - led de aviso para tochas sob tensão, proteções - led de aviso para troca de consumíveis - arrefecimento automático da tocha - visualização da pressão do ar - proteções termostática, sobrecarga, quebra de voltagem, picos de corrente. Fornecidos com tocha.

TECHNOLOGY PLASMA 60 XT - SUPERIOR PLASMA 70



XT

inverter

GOUGING

MANUAL & AUTOMATIC CUTTING

mod. Plasma 70



STANDARD

4m PH
mod. 60 XT - 804155

6m PV
mod. 70 - 804041

AIR PRESSURE
REGULATOR
mod. 60 XT - 125237

mod. 70 - 120203

5m
AX25

OPTIONAL

TORCH
FOR AUTOMATIC
SYSTEMS

12m PX A
mod. 70 - 802955



CONNECTING
CABLE CNC
10m - mod. 70
804976

PH PERFORMANCE
TORCH
CONSUMABLES BOX
mod. 60 XT
804417



PV TORCH
CONSUMABLES BOX
mod. 70
804108



PXA TORCH
ACCURCUT
CONSUMABLES

45A nozzles 5 pcs
mod. 70
804315



45A shields 2 pcs
mod. 70
804316



MMS-10 MOISTURE
& MIXTURE STOP
FILTER
804340



MMS-10 AIR FILTER
CARTRIDGES (4pcs)
804343



CIRCULAR
CUTTING UNIT
Ø max 680mm
mod. 60 XT - 804169



mod. 70
804059



TROLLEY
AMERICA
mod. 70
803084



TECHNICAL DATA

CE EAC	CODE	V _{PH}	A _{MIN} / A _{MAX}	A _{MAX} 40°C	V ₀	A _{MAX}	P _{MAX}	η	φ	MAX	I/min	bar	IP	LxWxH	kg
		V (50-60Hz)	A	EN 60974-1 A	V	A	kW	%	mm					cm	kg
TECHNOLOGY PLASMA 60 XT	816148	230 1ph	10 - 60	50A @ 30 %	313	34	5,5	90	0,7	20	100	4 - 5	IP23	50,6 x 18,2 x 29,2	10,3
SUPERIOR PLASMA 70	816170	230 / 400 3ph	20 - 70 (400V)	70 @ 30%	325	13	8,5	90	0,9	30	200	4 - 5	IP23	47 x 19 x 35,5	15,8
			20 - 50 (230V)	50 @ 35%	310	16	5,5			20					

EN/ Inverter, compressed air plasma cutting systems, with contact striking of pilot arc. Allow a rapid, distortion-proof cutting of all conductive materials such as steel, stainless steel, galvanized steel, aluminium, copper, brass, etc. Possibility to interface with automated cutting systems (mod.70). Complete with torch.

IT/ Sistemi inverter di taglio al plasma ad aria compressa, con innescò a contatto dell'arco pilota. Consentono il taglio veloce senza deformazione, il taglio su grigliato e la scriccatura di tutti i materiali conduttori quali acciaio, acciaio inox, acciaio galvanizzato, alluminio, rame, ottone, ecc. Possibilità di interfaccia con sistemi di taglio automatizzati (mod.70). Completi di torcia.

FR/ Systèmes inverter, de découpage au plasma à air comprimé avec amorçage de l'arc pilote à contact. Permettent un découpage rapide et sans déformations de tous les matériaux conducteurs tels que acier, acier inox, acier galvanisé, aluminium, cuivre, laiton, etc. Possibilité d'interface avec des systèmes de découpage automatisés. (mod.70). Fournis avec torche.

ES/ Sistemas inverter de corte por plasma con aire comprimido, con encendido por contacto del arco piloto. Permiten cortar rápidamente y sin deformaciones todos los materiales conductores como acero, acero inoxidable, acero galvanizado, aluminio, cobre, latón, etc. Posibilidad de interfaz con sistemas de corte automatizados (mod.70). Equipados con antorcha.

DE/ Invertersysteme für das Druckluft-Plasmaschneiden mit Kontaktzündung des Pilotlichtbogens. Zum schnellen, verformungsfreien Schneiden aller leitenden Werkstoffe wie Stahl, Edelstahl, verzinktem Stahl, Aluminium, Kupfer, Messing, usw. Es besteht die Möglichkeit zur Anbindung an automatischen Schneidanlagen (mod.70). Komplett mit Brenner.

PT/ Sistemas inverter de corte por jato plasma com ar comprimido, com início por contacto do arco piloto. Permitem um corte rápido, sem deformações, corte de grades e ranhuras em todos os materiais condutores como aço, aço inoxidável, aço galvanizado, alumínio, cobre, latão, etc. Permitem a interface com sistemas de corte automáticos (mod.70). Fornecidos com tocha.

MMA WELDING

MIG-MAG WELDING

TIG WELDING

PLASMA CUTTING

SPOT WELDING

CHARGING & STARTING

INDEX

TECHNOLOGY TIG 222 AC/DC-HF/LIFT VRD



inverter

PULSE

EASY PULSE

THINSPOT

VRD
VOLTAGE REDUCTION DEVICE



GREEN LINE PROFESSIONAL TIG TORCHES

(optional) **HIGHER EFFICIENCY**

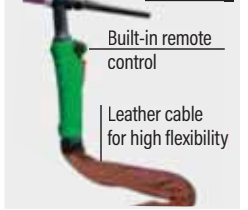

Built-in remote control

Leather cable for high flexibility

STANDARD

4m ST26 742614	
722119	3m AX50
IT 432036	802067

OPTIONAL

CONSUMABLES BOX ST26 804138 	TIG WELDING KIT 802788 	TIG TORCHES WITH POTENTIOMETER Green line ST26 4m 742618 8m 742619 + 	CRYSTAL BOX CLEAR CUP Ø 1,6 - 804204 CHAMPAGNE Ø 1,6 - 804202 	ELECTRODE HOLDER 25 mm ² 4m AX50 804123 	TROLLEYS ARCTIC 803059
QUICK GAS CONNECTOR 804208 	TIG TORCH ST26 8m 742616 	REMOTE DEVICE 802810 	STAINLESS STEEL TIG CLEANING KIT CLEANTECH 200 850020 	REMOTE CONTROLS 2 pot. 802336 Pedal 802017 	AMERICA 803084
					COSMOPOLITAN 803079

TECHNOLOGY TIG 222 AC/DC-HF/LIFT VRD

816033 	kg 11,3kg
------------	---------------------

TECHNICAL DATA

CE EAC	CODE	V _{1PH} ≐	A _{MIN} MAX DC	A _{MAX} 40°C DC	A _{60%} 40°C DC	V _O DC	A _{MAX}	A _{60%}	P _{MAX}	P _{60%}	≐	η	φ	∅ _{DC} MIN/MAX	IP	LxWxH	kg
		V (50-60Hz)	A	A	A	V	A	A	kW	kW	A	%	°	mm		cm	kg
TECHNOLOGY TIG 222 AC/DC-HF/LIFT VRD + accessories	852054	230 1ph	5 - 200	200 @ 24 %	115	95	33	21	5,5	3,3	20	81	0,7	1,6 4	IP23	43 x 17 x 34	16,4

EN/ TIG (high frequency HF or LIFT striking), PULSE TIG and MMA inverter welding machine in direct and alternating current (AC/DC). Use with a wide range of materials such as steel, stainless steel, titanium, copper, nickel and their alloys, aluminium, magnesium and their alloys. Features: pulse and EASY pulse operation - adjustable pre-heating for simpler striking in AC - THINSPOT function for quick and precise tack welding - VRD device - remote control connector. Complete with TIG welding accessories.

IT/ Saldatrice inverter TIG (innesco alta frequenza HF o LIFT), TIG PULSATO ed MMA in corrente continua e alternata (AC/DC). Impiego con diversi tipi di materiali quali acciaio, acciaio inox, titanio, rame, nichel e loro leghe, alluminio, magnesio e loro leghe. Caratteristiche: funzionamento in pulsato e pulsato EASY - pre-riscaldamento regolabile per innesco facilitato in AC - utility THINSPOT per una rapida e precisa saldatura a punti - dispositivo VRD - predisposizione per comando a distanza. Completa degli accessori di saldatura TIG.

FR/ Poste de soudage inverter TIG (amorçage haute fréquence HF et LIFT), PULSE TIG et MMA en courant continu et en courant continu et alternatif (AC/DC). Utilisation pour différents types de matériaux tels que acier, acier inox, titane, cuivre, nickel et leurs alliages, aluminium, magnésium et leurs alliages. Caractéristiques: fonctionnement en pulsé et EASY pulsé - préchauffé réglable pour amorçage facilité en CA - fonctionnalité THINSPOT, qui permet des soudages par points rapides et précis - dispositif VRD - prévu pour contrôle à distance. Fourni avec accessoires de soudage TIG.

ES/ Soldadora inverter TIG (encendido alta frecuencia HF y LIFT), TIG PULSADO y MMA en corriente continua y alterna (AC/DC). Uso con los materiales más variados como acero, acero inoxidable, titanio, cobre, níquel y sus aleaciones, aluminio, magnesio y sus aleaciones. Características: funcionamiento en pulsado y pulsado EASY - precalentamiento ajustable para cebado facilitado en CA - THINSPOT función para la soldadura por puntos rápido y preciso - dispositivo VRD - predisposición para el control a distancia. Equipada con accesorios para soldadura TIG.

DE/ Inverterschweißgerät zum Schweißen mit Gleich- und Wechselstrom (AC/DC), nach dem WIG, PULSE WIG (Hochfrequenz HF und LIFT Zündung) - und MMA Verfahren. Arbeiten mit den verschiedensten Werkstoffen wie Stahl, Edelstahl, Titan, Kupfer, Nickel und ihren Legierungen, Aluminium, Magnesium und ihren Legierungen. Eigenschaften: Betrieb mit Impulsstrom und EASY Impulsstrom - einstellbares Vorheizen für eine unterstützte AC-Zündung - Funktion THINSPOT, die zügige, präzise Punktschweißungen ermöglicht - VRD Vorrichtung - Fernkontrollanschluss. Komplett mit Schweißzubehör für WIG Schweißen.

PT/ Aparelho de soldar inverter TIG (ignição HF ou LIFT de alta frequência), PULSE TIG e MMA em corrente contínua e alternada (AC/DC). Utilização com uma ampla variedade de materiais como aço, aço inoxidável, titânio, cobre, níquel e suas ligas, alumínio, magnésio e suas ligas. Características: funcionamento pulso e EASY pulso - pré-aquecimento ajustável para maior facilidade de ignição em AC - função THINSPOT para precisão e rapidez de soldadura por pontos - dispositivo VRD. Fornecido com acessórios de soldadura TIG.

INDUCTOR 3000



TELWIN



NEW



STANDARD

10V M8/M10
801413
14V M12/M14
801414



OPTIONAL

HORIZONTAL

10H M8/M10 2pcs
801416
14H M12/M14 2pcs
801417

18H M16/M18 2pcs
801605



VERTICAL

10V M8/M10 2pcs
801413
14V M12/M14 2pcs
801414

18V M16/M18 2pcs
801604



KIT WIRES FOR
TWISTER
2pcs
801419



TECHNICAL DATA

CE EAC	CODE	V _{1PH} V (50-60Hz)	P _{MAX} kW	F kHz	P _{EFF} kW	IP	LxWxH cm	kg
INDUCTOR 3000	835013	200 - 240 1ph	1,3	35 - 100	1,2	IP21	28 x 12,5 x 17	3,6

EN/ Portable induction heater that allows fast release of bolts, nuts, gears, joints and screws. It is particularly useful for applications in bodyshops, garages, farming, maintenance, metal machining, etc. By adjusting power, heat is transferred to the part to be unlocked in a localised and precise manner. Supplied with Twister 10V M8/M10 and 14V M12/ M14 accessories.

IT/ Riscaldatore ad induzione portatile che permette di sbloccare velocemente bulloni, dadi, ingranaggi, giunti, viti. Risulta particolarmente utile per applicazioni in carrozzeria, autofficina, in agricoltura, nella manutenzione, lavorazione metalli, etc. Attraverso la regolazione della potenza, trasferisce calore nella parte da sbloccare in maniera localizzata e precisa. Completo degli accessori Twister 10V M8/M10 e 14V M12/ M14.

FR/ Réchauffeur à induction portatif pour le déblocage rapide de boulons, écrous, engrenages, joints, vis. Ce dispositif est particulièrement utile pour les applications de carrosserie, garages, l'agriculture, l'entretien, le travail de métaux, etc. À travers le réglage de la puissance, il transfère de la chaleur dans la partie à débloquent de façon localisée et précise. Fourni avec les accessoires Twister 10V M8/M10 et 14V M12/ M14.

ES/ Calentador por inducción portátil que permite desbloquear rápidamente pernos, tuercas, engranajes, juntas o tornillos. Es especialmente útil para aplicaciones en carrocería, taller, agricultura, mantenimiento o elaboración de metales, etc. Con la regulación de la potencia, transfiere calor a la parte que desbloquear de manera localizada y precisa. Incluye los accesorios Twister 10V M8/M10 y 14V M12/ M14.

DE/ Tragbare Induktionsheizung zum schnellen Lösen von Bolzen, Muttern, Zahnrädern, Verbindungen und Schrauben. Besonders nützlich bei Anwendungen beispielsweise in der Karosserie- und Autowerkstatt, in der Landwirtschaft, bei der Wartung und bei Metallbearbeitungen. Durch die Einstellung der Leistung wird die Wärme in den zu lösenden Bereich punktgenau übertragen. Mit dem Zubehör Twister 10V M8/M10 und 14V M12/ M14.

PT/ Sistema de aquecimento por indução portátil que permite desbloquear rapidamente cavilhas, porcas, engrenagens, juntas, parafusos. Particularmente útil para aplicações em carroçaria, oficinas automóveis, agricultura, manutenção, metalurgia, etc. Através da regulação da potência, transfere calor para a peça a desbloquear de forma localizada e precisa. Inclui os acessórios Twister 10V M8/M10 e 14V M12/ M14.

MMA WELDING

MIG-MAG WELDING

TIG WELDING

PLASMA CUTTING

SPOT WELDING

CHARGING & STARTING

INDEX

SMART INDUCTOR 5000



ADVISED BY



Smart-Protection



Smart-Activation



VERSION: CLASSIC

TECHNICAL DATA

CE EAC	CODE	V _{1PH} V (50-60Hz)	P _{MAX} kW	F ₀ kHz	P ₀ kW	IP	LxWxH cm	kg	COMPLETE WITH								
									HEAT TWISTER	SUPER REMOVER	PAD INDUCTOR	LEVERS (3pcs)	REMOTE CONTROL	GLASS GENIUS	WONDER PEN II	METAL RELEASER	
	835012							7,3	■								
	865011	200 - 240 1ph	2,4	35 - 100	2,3	IP21	39 x 26 x 23	10,4	■	■	■	■	■				
	865012							13,6	■	■	■	■	■	■	■	■	■

EN/ Induction heating system. Intelligent solution for speeding up and simplifying the removal of glued (windows, rear windows, plastic parts, stickers, glass roofs, interior and exterior trims, etc.) or blocked (bolts, bearings, gears, etc.) parts as well to facilitate the repair of hail dents. Features: intelligent control by DynamicCheck system - user-friendly digital panel - automatic and manual mode - activation and correct operation signals - pushbutton control for Super Remover and Glass Genius - foot control.

IT/ Sistema di riscaldamento ad induzione. Soluzione intelligente per velocizzare e semplificare le operazioni di rimozione di parti incollate (vetri, lunotti, plastiche, adesivi, cieli, rivestimenti interni ed esterni, etc.), bloccate (bulloni, cuscinetti, ingranaggi, etc.) e per facilitare la riparazione di ammaccature da grandine. Caratteristiche: controllo intelligente con sistema DynamicCheck - pannello digitale user friendly - modalità automatica e manuale - segnalazione attivazione e corretto funzionamento - comando a pulsante per Super Remover e Glass Genius - comando a pedale.

FR/ Système de réchauffement à induction. Solution intelligente pour accélérer et simplifier les opérations d'enlèvement dans les véhicules de parties collées (verres, lunettes, plastiques, adhésifs, toits des voitures, revêtements internes et externes, etc.) ou bloquées (boulons, roulements, engrenages, etc.) et pour faciliter la réparation de bosses provoquées par la grêle. Caractéristiques: contrôle intelligent grâce au système DynamicCheck - tableau numérique convivial - modalités automatique et manuelle - signalisation d'activation et de fonctionnement correct - commande à bouton pour Super Remover et Glass Genius - commande à pédale.

ES/ Sistema de calentamiento de inducción. Solución inteligente para agilizar y simplificar las operaciones de remoción en los vehículos de partes encoladas (vidrios, lunetas, plásticos, pegatinas, techos de los vehículos, revestimientos internos y externos, etc.) o bloqueadas (pernos, rodamientos, engranajes, etc.) y para facilitar la reparación de abolladuras causadas por el granizo. Características: control inteligente con sistema DynamicCheck - panel digital userfriendly - modalidad automática y manual - señalización de la activación y funcionamiento correcto - control de pulsador para el Super Remover y Glass Genius - control de pedal.

DE/ Dieses induktive Erhitzungssystem. Intelligente Lösung zum schnellen und einfachen Entfernen von angeklebten Fahrzeugteilen (z.B.: Glas, Heckscheiben, Kunststoffteile, Aufkleber, Fahrzeughimmel, Innen- und Außenverkleidungen) oder von anderweitig befestigten Fahrzeugteilen (z.B.: Bolzen, Lager, Zahnräder) und zum Erleichtern die Reparatur von Beulen durch Hagel verursacht. Eigenschaften: intelligente Steuerung durch das System „DynamicCheck“ - bedienerfreundliche Digitaltafel - automatische und manuelle Betrieb - Signalgebung bei Aktivierung und einwandfreiem Betrieb - Tastensteuerung für Super Remover und Glass Genius - Pedalsteuerung.

PT/ Sistema de aquecimento por indução. Solução inteligente para acelerar e simplificar a remoção de peças coladas (janelas, janelas traseiras, plásticos, adesivos, acabamentos interiores e exteriores, etc.), peças presas (parafusos, rolamentos, engrenagens, etc.) e para facilitar a reparação de amolgadelas de granizo. Características: controlo inteligente através do sistema DynamicCheck - painel digital de fácil utilização - modo automático e manual - sinalização de ativação e funcionamento correto - botão de comando para Super Remover e Glass Genius - pedal de comando.

FOR STUCK & RUSTED PARTS

HEAT TWISTER

801412



CONSUMABLES:

VERTICAL:

kit 2 Twister 10V M8/M10 - 801413

kit 2 Twister 14V M12/M14 - 801414

kit 2 Twister 18V M16/M18 - 801415

kit 2 Twister Wires
801419

HORIZONTAL:

kit 2 Twister 10H M8/M10 - 801416

kit 2 Twister 14H M12/M14 - 801417

kit 2 Twister 18H M16/M18 - 801418

METAL RELEASER

801401



EN/ Bolts · Nuts · Screws · Bearings · Hooks · Tie-rods · Hinges · Gears

IT/ Bulloni · Dadi · Viti · Cuscinetti · Ganci · Tiranti · Cardini · Ingranaggi

FR/ Boulons · écrous · Vis · roulements · Crochets · tirants · Charnières · engrènements

ES/ Pernos · Tuercas · Tornillos · Rodamientos · Ganchos · Tirantes · Goznes · Engranajes

DE/ Bolzen · Muttern · Schrauben · Lager · Haken · Streben · Türangeln · Zahnräder

PT/ Porcas · Parafusos · Rolamentos · Ganchos · Tirantes · Charneiras · Engrenagens

FOR HAIL DENTS & DENTS

WONDER PEN II

801420



EN/ It works on hail dents without removing the paint.

IT/ Agisce sulle ammaccature da grandine senza sverniciare.

FR/ Agit sur les bosses provoquées par la grêle sans élever la peinture.

ES/ Actúa en las abolladuras por granizo sin necesidad de remover la pintura.

DE/ Repariert Hagelbeulen, ohne den Lack anzugreifen.

PT/ Atua nas pequenas mossas sem remover a pintura.

EXTENTION

801421



DENT REPAIR CORDLESS LED LAMP

804455

NEW

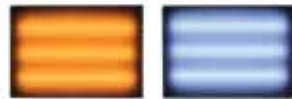

2 colours-dimmable lights (hot-cold)



Rechargeable lithium battery

EN/ It helps to identify the dents on the bodywork.

IT/ Aiuta ad individuare le ammaccature sulla carrozzeria.

FR/ Il permet d'identifier les bosses sur la carrosserie.

ES/ Ayuda a identificar las abolladuras en la carrocería.

DE/ Es hilft, die Beulen an der Karosserie zu identifizieren.

PT/ Ajuda a identificar as mossas na carroçaria.

FOR GLASS

GLASS GENIUS

804103



EN/ Quick removal of glass on parts to be painted · Removal of glasses with great amount of sealant (eg. Vans) · Allows the reuse of glass with built-in seal.

FR/ Enlèvement rapide de vitre sur des parties à peindre · Enlèvement efficace de vitres même si elles ont beaucoup de colle (ex. Fourgons) · Permet la réutilisation de vitres avec garnitures incorporée.

DE/ Bequemer Ausbau von den Glasscheiben für Lackierarbeit · Wirksame Entfernung von Scheiben unabhängig von der Dichtungsstärke (PKW sowie NFZ) · Gestattet die Wiederverwendung von Scheiben mit eingebauter Dichtung.

SUPER REMOVER

801400



IT/ Rapida rimozione di vetri su parti da verniciare · Efficace rimozione di vetri anche con maggiore quantità di sigillante (es. Furgoni) · Permette il riutilizzo di vetri con guarnizione incorporata.

ES/ Rápida remoción de vidrios en partes que tienen que pintarse · Remoción efectiva de vidrios incluso con mayor cantidad de sellador (p.e. Furgonetas) · Permite el reuso de vidrios con junta incorporada.

PT/ Rápida remoção de vidros em zonas a pintar · Remoção de vidros com grande quantidade de vedante (ex. furgonetas) · Permite a reutilização do vidro com vedante incorporado.



FOR PROTECTIONS AND EXTERIOR TRIMS

SUPER REMOVER

801400



EN/ Anti-Gravel protections · Protective films · Exteriors trims

IT/ Rivestimenti anti-graiaia · Pellicole protettive · Rivestimenti esterni

FR/ Revêtements anti-gravillon · Pellicules de protection · Revêtements externes

ES/ Revestimientos anti-gravilla · Películas de protección · Revestimientos externos

DE/ Schutzverkleidungen gegen Steinschlag · Schutzfolien · Außenverkleidungen

PT/ Pára-lamas · Películas de proteção · Frisos exteriores



FOR ADHESIVE AND GLUED PARTS EASILY

PAD INDUCTOR

801402



EN/ Adhesives · Graphics, Logos · Labels · Data Tables · Mouldings · Side plastics · Glass roofs · Interior trims · Sealants · Vinyl roofs · Fluid threadlocker

IT/ Adesivi · Grafica, loghi · Etichette · Targhe Dati · Modanature · Plastiche laterali · Cieli delle vetture · Rivestimenti interni · Sigillanti · Tetti in vinile · Liquido frenafiletto

FR/ Autocollants · Graphismes, Logos · Étiquettes · Plaquettes de données · Moulures · Plastiques Latéraux · Toits des voitures · Revêtements internes · Mastics · Toits en vinyle · Liquide de blocage des filets

ES/ Adhesivos · Gráfica, Logotipos · Etiquetas · Placas de Datos · Molduras · Plásticos laterales · Techos de los vehículos · Revestimientos internos · Selladores · Techos de vinilo · Líquido frenaroscas

DE/ Aufkleber · Schriftzüge, Logos · Etiketten · Typenschilder · Zierleisten · Seitliche Kunststoffelemente · Fahrzeughimmel · Innenverkleidungen · Dichtungsmittel · Vinyltächer · Gewindegewissungsmittel

PT/ Autocolantes · Grafismos, logotipos · Etiquetas · Placas de dados · Molduras · Plásticos laterais · Tetos de abrir · Frisos internos · Vedantes · Tetos em vinil · Colas de roscas

D-ARC 200



STANDARD

D-ARC GUN



FLAT HOOK WASHERS
AlMg (50 pcs)
804140

OPTIONAL

D-ARC DELUXE BOX
804412



CONTENT

AlMg		804140	50 pcs	AlMg		804141	50 pcs
AlSi		804142	50 pcs	AlSi		804143	50 pcs
Al 99,5%		804250	50 pcs	Al 99,5%		804251	50 pcs
		804147	1 pc			742778	1 pc
						804145	50 pcs

MULTI PIN
EXTRACTOR
804154



MULTI PIN
EXTRACTOR
804147



PIN
EXTRACTOR
742778



TROLLEYS

AMERICA
803084



CONSUMABLES

FLAT HOOK WASHERS
(50pcs)

Al 99,5% 804250	AlMg 804140	AlSi 804142	PIN (50pcs)
			AlMg 804145

TWISTED HOOK WASHERS
(50pcs)

Al 99,5% 804251	AlMg 804141	AlSi 804143	
--------------------	----------------	----------------	--

TECHNICAL DATA

CE EAC	CODE	V _{1PH} V (50-60Hz)	A _{OUT} A	V ₀ V	P _{MAX} kW		A	η %	φ %	DUTY CYCLE %	IP	LxWxH cm	kg
● D-ARC 200	816160	230 1ph	200	80	6,3	10	92	0,7	2	IP23	38,5 x 15 x 26,5	7,4	

EN/ D-Arc 200 is a microprocessor controlled, electronic system fit for applications on aluminium in car body shops. The short arc technology makes it possible to weld hook washers and studs on aluminum alloy panels quickly and precisely. Adjustment of welding current. It is equipped with D-Arc gun and hook washers.

IT/ D-Arc 200 è un sistema elettronico controllato a microprocessore adatto per le applicazioni in carrozzeria su alluminio. La tecnologia ad arco corto rende possibile la saldatura di rondelle asolate e perni su pannelli in lega di alluminio in maniera veloce e precisa. Regolazione della corrente di saldatura. Dotato di pistola D-Arc e rondelle asolate.

FR/ D-Arc 200 est un système électronique contrôlée par microprocesseur, conçu pour les applications sur aluminium dans le secteur de la carrosserie. La technologie à arc court permet de souder rapidement et précisément des rondelles à crochet et des goujons sur des panneaux en alliage d'aluminium. Réglage du courant de soudage. Fourni de série avec pistolet D-Arc et anneaux.

ES/ D-Arc 200 es un sistema electrónico controlado por microprocesador adecuado para aplicaciones de aluminio en carrocería. La tecnología de arco corto permite soldar arandelas con gancho y pernos en paneles de aleación de aluminio, de forma rápida y precisa. Ajuste de la corriente de soldadura. Equipado con pistola D-Arc y arandelas con gancho.

DE/ D-Arc 200 ist ein mikroprozessorgesteuertes, elektronisches System für Anwendungen im Karosseriebau. Die Kurzlichtbogen-Technologie ermöglicht es, Hakenscheiben und Bolzen auf Aluminiumlegierungsplatten schnell und präzise zu schweißen. Einstellung des Schweißstroms. Zum Lieferumfang gehören eine D-Arc Pistole und Anschweißösen.

PT/ O D-Arc 200 é um sistema eletrônico controlado por microprocessador adequado para uso em oficinas de reparação de automóveis. A tecnologia de arco curto permite soldar arruelas de gancho e pinos em painéis de liga de alumínio com rapidez e precisão. Ajuste de corrente de soldagem. Fornecido com uma pistola D-Arc e arruelas de gancho.

BATTERY PULLER



BODYSHOP

INTELLIGENT POWER
MANAGEMENT



MORE INFO

STANDARD

OPTIONAL



BATTERY
982346



**HOOK WASHERS
HOLDER KIT**
804314



**FLAT HOOK
WASHERS**
50 pcs
802943



**TWISTED HOOK
WASHERS**
50 PCS
802944

TIPS
10 pcs
804254



TECHNICAL DATA

CE EAC	CODE	V _{PH}	A _{MAX}	V ₀	A _{OUT}	IP	LxWxH	kg
		V (50-60Hz)	A	V	A		cm	kg
● BATTERY PULLER	828130	100-240 1 ph	2800	7,4	1800	IP20	50,2x8,7x22,9	2,3



EN/ Lithium battery spotter best suitable for all straightening processes of steel sheets. Cable-free, it is ergonomic and very handy, and offers a secure grip in all working positions. Designed for fast repairs, it can be used in any area of the bodywork including those of preparation. The on-board digital control allows you to synergistically vary the welding parameters based on the type of work carried out. The interchangeable and rechargeable LiPo4 lithium battery guarantees continuity in processing. Complete with: Power supply, battery, plastic professional carry case.

IT/ Spotter con batteria al litio, ideale per tutte le lavorazioni di raddrizzatura delle lamiere in acciaio. Privo di cavi, è ergonomico e molto maneggevole, e offre una presa sicura in tutte le posizioni di lavorazione. Studiata per le riparazioni veloci può essere usata in qualsiasi zona della carrozzeria comprese quelle di preparazione. Il controllo digitale a bordo, permette di variare in modo sinergico i parametri di saldatura in base al tipo di lavoro. La batteria al litio LiPo4 è intercambiabile e ricaricabile e garantisce continuità nelle lavorazioni. Completo di: caricatore, batteria, valigetta professionale in plastica.

● Bodyshop product

FR/ Spotter à batterie au lithium indiqué pour toutes les opérations de redressement des tôles en acier. Sans câble, il est ergonomique et très maniable, et garantit une préhension sûre en toute position de travail. Conçu pour les réparations rapides, il peut être utilisé dans toutes les zones de la carrosserie, zones de préparation comprises. Le contrôle numérique incorporée permet de varier de manière synergique les paramètres de soudage en fonction du type de travail. Avec sa batterie au lithium LiPo4 interchangeable et rechargeable, il garantit une continuité de travail. Fourni avec: chargeur, batterie, mallette professionnelle en plastique.

ES/ Spotter con batería de litio, ideal para todas las operaciones de enderezado en chapas de acero. Sin cables, ergonómico y muy fácil de manejar, ofrece un agarre seguro en todas las posiciones de trabajo. Diseñado para reparaciones rápidas, puede utilizarse en cualquier zona de la carrocería, incluidas las zonas de preparación. El control digital a bordo permite la variación sinérgica de los parámetros de soldadura en función del tipo de trabajo. La batería de litio LiPo4 intercambiabile y recargable garantiza la continuidad del trabajo. Completo con: cargador, batería, maletín de plástico profesional.

DE/ Spotter mit Lithiumbatterie eignet sich für alle Bearbeitungen des Geraderichtens von Stahlblechen. Es ist kabellos, ergonomisch und sehr handlich und bietet einen sicheren Griff in allen Arbeitspositionen. Entwickelt für schnelle Reparaturen, kann es in jedem Bereich der Karosserie einschließlich der Vorbereitungsbereiche verwendet werden. Die eingebaute Digitalsteuerung ermöglicht eine synergetische Einstellung der Schweißparameter je nach Art der Arbeit. Die austauschbare und aufladbare Lithiumbatterie LiPo4 gewährleistet Kontinuität bei den Bearbeitungen. Komplett mit: Ladegerät, Batterie, Profi-Kunststoffkoffer.

PT/ Spotter de bateria de lítio indicado para todos os trabalhos de endireitamento de chapas de aço. Sem cabos, ergonómico e muito fácil de manusear, oferece uma preensão segura em qualquer posição de trabalho. Estudado para reparações rápidas pode ser utilizado em qualquer zona da carroçaria, incluindo as de preparação. O controlo digital de bordo permite alterar de forma sinérgica os parâmetros de soldadura com base no trabalho a executar. A bateria de lítio LiPo4 intercambiável e recarregável, garante continuidade nos trabalhos. Completo com: carregador, bateria, caixa de plástico profissional.

MMA WELDING

MIG-MAG WELDING

TIG WELDING

PLASMA CUTTING

SPOT WELDING

CHARGING & STARTING

INDEX

PULLER 4000



STANDARD



5 pcs

OPTIONAL

DENT PULLING ACCESSORIES



Pag. 44/45

PULLING BAR

802433



COMPACT PULLER

802599



TROLLEY AMERICA

803084



STEEL STARTER STATION

804902



TECHNICAL DATA

CE EAC	CODE	V _{1PH} V (50-60Hz)	A _{MAX} A	V ₀ V	P _{MAX} kW	P _{50%} kW	⊞ A	∅ mm	A _{OUT} A	DUTY CYCLE %	IP	LxWxH cm	kg
PULLER 4000	828129	230 1 ph	2600	5,6	7	1,2	16	0,8	1800	1,5	IP22	39 x 26 x 22,5	16

EN/ Microprocessor controlled, electronic system for repairing of metal sheets, fit for applications in car body shops. Adjustment of welding current according to the part to be welded (star for traction, hook washer, studs, wavy wire, etc.). Complete with manual gun, earth cable with pointing mass, extractor, spindle and pulling stars.

IT/ Sistema elettronico controllato a microprocessore per la riparazione di lamiera, adatto per applicazioni in carrozzeria. Regolazione della corrente di saldatura in base all'elemento da puntare (stella per trazione, rondella asolata, perno, filo ondulato, etc.). Completo di pistola manuale, cavo di massa con massa a puntare, estrattore, mandrino e stelle per trazione.

FR/ Système électronique pour la réparation de tôles de métal contrôlée par microprocesseur, conçu pour les applications dans le secteur de la carrosserie. Réglage du courant de soudage en fonction de l'élément à pointer (étoile pour traction, rondelle à crochet, goujons, fil ondulée, etc.). Fourni avec pistolet manuel, câble de masse et masse pour pointage, extracteur, mandrin et étoiles pour traction.

ES/ Sistema electrónico para la reparación de chapas, controlado por microprocesador, adecuado para aplicaciones en carrocería. Ajuste de la corriente de soldadura según el elemento a apuntar (estrella para tracción, arandela ranurada, pernos, hilo ondulado, etc.). Equipado con pistola manual, cable de masa con masa para punteado, extractor, mandril y estrellas para tracción.

DE/ Mikroprozessorgesteuertes, elektronisches System für die Reparatur von Bleche, besonders geeignet für Anwendungen im Karosseriebau. Einstellung des Schweißstroms nach dem zu schweißenden Element (Stern für Zugkraft, Anschweißösen, Bolzen, Welldraht usw.). Zum Lieferumfang gehören eine manuelle Pistole, Massekabel mit Punktschweissen Masse, Zugerät, Spindel und Zugsterne.

PT/ Sistema eletrónico controlado por microprocessador, para reparação de chapas metálicas em oficinas de bate-chapas. Regulação da corrente de soldadura em função da peça a soldar (estrela para tração, arruelas de gancho, pernos, fio ondulado, etc.). Equipado com pistola manual, cabo de massa com massa para pontos, extrator, mandril e estrelas de tração.

DIGITAL PULLER 5500



ONE TOUCH



0.6 mm

Set the thickness and start working!

AUTOMATIC

STANDARD

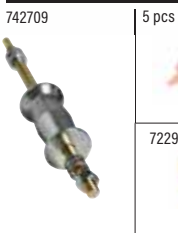

OPTIONAL

DENT PULLING ACCESSORIES



Pag. 44/45

DIGITAL PULLER ACCESSORIES KIT



Pag. 32

TROLLEY AMERICA 803084



STEEL STARTER STATION 804902



TECHNICAL DATA

CE EAC	CODE	V _{PH}	A _{MAX}	V ₀	P _{MAX}	P _{50%}	⊖	∅	A _{OUT}	DUTY CYCLE	IP	LxWxH	kg
		V (50-60Hz)	A	V	kW	kW	A		A	%		cm	kg
DIGITAL PULLER 5500 (400V)	828128	400 2 ph	3800	5,6	10,5	1,8	10	0,8	2500	1,5	IP22	39 x 26 x 22,5	21
DIGITAL PULLER 5500 (230V)	828127	230 1 ph					16						

EN/ Microprocessor controlled, electronic system for repairing of metal sheets, fit for applications in car body shops. The LCD digital, multifunction control panel allows the automatic regulation of the spot welding parameters according to the chosen tool. Complete with automatic gun, work cable with pointing mass, extractor, spindle and pulling stars.

IT/ Sistema elettronico per la riparazione di lamiera, controllato a microprocessore adatto per applicazioni in carrozzeria. Il pannello digitale LCD multifunzione consente la regolazione automatica dei parametri in base all'utensile scelto. Completo di pistola automatica, cavo di massa con massa a puntare, estrattore, mandrino e stelle per trazione.

FR/ Système électronique pour la réparation de tôles de métal contrôlée par microprocesseur, conçu pour les applications dans le secteur de la carrosserie. Le tableau numérique LCD, multifonction permet la régulation automatique des paramètres de pointage en fonction de l'outil choisi. Fourni avec pistolet pneumatique, câble de masse avec masse pour pointage, extracteur, mandrin et étoiles pour traction.

ES/ Sistema electrónico para la reparación de chapas, controlado por microprocesador, adecuado para aplicaciones en carrocería. El panel digital LCD, multifunción permite la regulación automática de los parámetros de punteado en función de la herramienta elegida. Equipado con pistola neumática, cable de masa con masa para punteado, extractor, mandril y estrellas para tracción.

DE/ Mikroprozessorgesteuertes, elektronisches System für Blechreparatur, besonders geeignet für Anwendungen im Karosseriebau. Das LCD-, digitale-, multifunktionelle Schaltbrett ermöglicht die automatische Regelung der Punktschweißparameter je nach Werkzeug. Zum Lieferumfang gehören eine pneumatische Pistole, Massekabel mit Massebuchse, Zuggerät, Spindel und Zugsterne.

PT/ Sistema eletrónico controlado por microprocessador, para reparação de chapas metálicas em oficinas de bate-chapas. Painel de controlo LCD digital, multifunções para regulação automática dos parâmetros de soldadura por pontos, em função da ferramenta escolhida. Equipado com pistola, cabo de massa com kit de fixação, extrator, mandril e estrelas de tração.

MMA WELDING

MIG-MAG WELDING

TIG WELDING

PLASMA CUTTING

SPOT WELDING

CHARGING & STARTING

INDEX

DIGITAL PULLER ACCESSORIES



DIGITAL PULLER ACCESSORIES KIT

804900



QUICK CONNECTION CABLE



RINGVOLVER

(50 pcs  INCLUDED)



QUICK HAMMERS KIT

RINGVOLVER

804023

(50 pcs flat hook washer included)

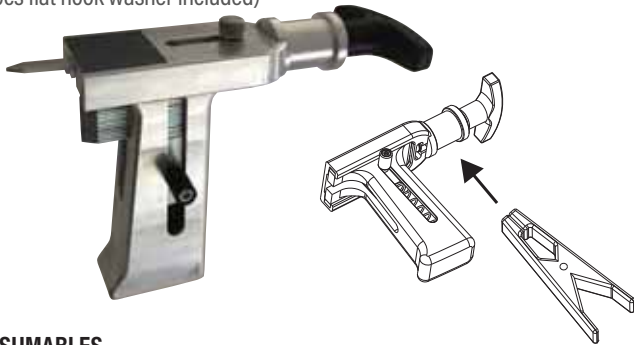

CONSUMABLES

FLAT HOOK WASHERS

802943 (50 pcs)



QUICK HAMMERS KIT

804024

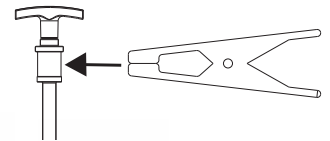

TEMPERING

742700

WAVY WIRES

742701

RINGS

742702

MINI SLIDE HAMMER

742703

CONSUMABLES

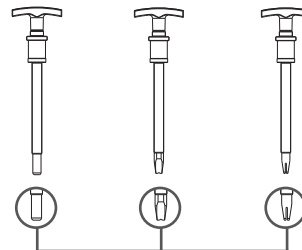

804026 (3 pcs)

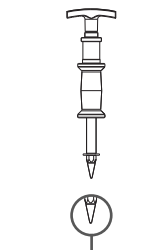

802464 (5 pcs)

QUICK CONNECTION CABLE

804027



PULL SYSTEM

804025



OPTIONAL

ROUND HEADED ELECTRODE
5pcs - 802445



TIP HEADED ELECTRODE
5pcs - 802444



SQUEEZING ELECTRODE
742331



DIGITAL PULLER 5500 DUO



BODYSHOP

ONE TOUCH



MMA WELDING
MIG-MAG WELDING
TIG WELDING
PLASMA CUTTING
SPOT WELDING
CHARGING & STARTING

AUTOMATIC

MANUAL

STANDARD

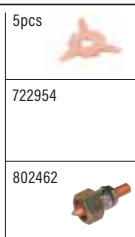

OPTIONAL



Pag. 44/45

TECHNICAL DATA

● DIGITAL PULLER 5500 DUO	CE	EAC	CODE	V _{1PH}	A _{MAX}	V ₀	P _{MAX}	P _{50%}	⊘	A _{OUT}	DUTY CYCLE	IP	LxWxH	kg	
				V (50-60Hz)	A	V	kW	kW	A	A	%		cm		
● DIGITAL PULLER 5500 DUO			828131	230 1ph	3800	5,6	10,5	1,8	16	0,8	2500	1,5	IP22	39 x 26 x 22,5	24

EN/ Microprocessor controlled, electronic system for repairing of metal sheets, fit for applications in car body shops. The LCD digital, multifunction control panel allows the automatic regulation of the spot welding parameters according to the chosen tool. Complete with automatic gun, manual gun, work cable with pointing mass, extractor, spindle and pulling stars.

IT/ Sistema elettronico per la riparazione di lamiere, controllato a microprocessore adatto per applicazioni in carrozzeria. Il pannello digitale LCD multifunzione consente la regolazione automatica dei parametri in base all'utensile scelto. Completo di pistola automatica, pistola manuale, cavo di massa con punta, estrattore, mandrino e stelle per trazione.

FR/ Système électronique pour la réparation de tôles de métal contrôlée par microprocesseur, conçu pour les applications dans le secteur de la carrosserie. Le tableau numérique LCD, multifonction permet la régulation automatique des paramètres de pointage en fonction de l'outil choisi. Fourni avec pistolet pneumatique, pistolet manuel, câble de masse avec masse pour pointage, extracteur, mandrin et étoiles pour traction.

ES/ Sistema electrónico para la reparación de chapas, controlado por microprocesador, adecuado para aplicaciones en carrocería. El panel digital LCD, multifunción permite la regulación automática de los parámetros de punteado en función de la herramienta elegida. Equipado con pistola neumática, pistola manual, cable de masa con masa para punteado, extractor, mandril y estrellas para tracción.

DE/ Mikroprozessorgesteuertes, elektronisches System für die Reparatur von Bleche, besonders geeignet für Anwendungen im Karosseriebau. Das LCD-, digitale-, multifunktionelle Schaltbrett ermöglicht die automatische Regelung der Punktschweißparameter je nach Werkzeug. Zum Lieferumfang gehören eine pneumatische Pistole, eine manuelle Pistole, Massekabel mit Massebuchse, Zuggerät, Spindel und Zugsterne.

PT/ Sistema eletrónico controlado por microprocessador, para reparação de chapas metálicas em oficinas de bate-chapas. Painel de controlo LCD digital, multifunções para regulação automática dos parâmetros de soldadura por pontos, em função da ferramenta escolhida. Equipado com pistola automática, pistola manual, cabo de massa com massa para pontos, extrator, mandril e estrelas de tração.

DIGITAL CAR SPOTTER 5500



ONE TOUCH



0.8 mm

Set the thickness and start working!

STANDARD

KIT STUDDER 802832

mod. 823232, 823219



KIT STUDDER AUTOMATIC 802833

mod. 823234, 823233



OPTIONAL

DENT PULLING ACCESSORIES



Pag. 44/45

MANUAL "X" GUN 801043



TROLLEY AMERICA 803084



TECHNICAL DATA

	CE EAC	CODE	V _{PH} V (50-60Hz)	A _{MAX} A	V ₀ V	P _{MAX} kW	P _{50%} kW	φ	A _{OUT} A	mm	DUTY CYCLE %	IP	LxWxH cm	kg
DIGITAL CAR SPOTTER 5500 (400V)		823232	400	4200	6	11	2	0,7	3000	1,5 + 1,5	3	IP22	39 x 26 x 22,5	26
DIGITAL CAR SPOTTER 5500 AUTOMATIC (400V)		823234	2 ph											
DIGITAL CAR SPOTTER 5500 (230V)		823219	230	4200	6	11	2	0,7	3000	1,5 + 1,5	3	IP22	39 x 26 x 22,5	26
DIGITAL CAR SPOTTER 5500 AUTOMATIC (230V)		823233	1 ph											

EN/ Microprocessor controlled, spot-welding machine fit for applications in car body shops. The LCD digital, multifunction control panel allows the automatic regulation of spot welding parameters according to the chosen tool and sheet thickness. Complete with the "STUDDER" kit for spot welding of screws, washers, rivets and pulling stars, sheet warming and upsetting.

FR/ Poste de soudage par points électronique, contrôlé par microprocesseur conçu pour les applications dans le secteur de la carrosserie. L' écran numérique LCD, multifonction permet la régulation automatique des paramètres de pointage en fonction de l'outil choisi et de l'épaisseur de la tôle. Fourni de série avec kit "STUDDER" pour soudage de vis, rondelles, rivets et étoiles pour traction, chauffage de tôles et refoulement.

DE/ Mikroprozessorgesteuertes, elektronisches, Punktschweißgerät, geeignet für Anwendungen im Karosseriebau. Das digitale-, LCD, multifunktionelle Schaltbrett ermöglicht die automatische Regelung der Punktschweißparameter je nach Werkzeug und Blechdicke. Zum Lieferumfang gehören das "STUDDER" Kit zum Punktschweißen von Schrauben, Unterlegscheiben, Nieten und Zugsterne, zum Erwärmen und Stauchen von Blechen.

IT/ Saldatrice a resistenza (puntatrice) elettronica, controllata a microprocessore, adatta per applicazioni in carrozzeria. Il pannello digitale LCD, multifunzione consente la regolazione automatica dei parametri di puntatura in funzione dell'utensile scelto e dello spessore della lamiera. E' fornita di serie con kit "STUDDER" per la puntatura di viti, rondelle, rivetti e stelle per trazione, scaldalaminiera, ricalcatura.

ES/ Soldadora por puntos electrónica, controlada por microprocesador, adecuada para aplicaciones en carrocería. El panel digital LCD, multifunción permite la regulación automática de los parámetros de punteado en función de la herramienta elegida y del espesor de la chapa. Equipada con el kit "STUDDER" para soldar por puntos tornillos, arandelas, remaches, estrellas para tracción, calentadores de chapas y recalado.

PT/ Aparelho de soldadura por pontos, controlado por microprocessador, para aplicação em oficinas de bate-chapas. Painel de controlo LCD digital, multifunções para regulação automática dos parâmetros de soldadura por pontos, em função da ferramenta escolhida e da espessura da chapa. Equipado com kit CHAPEIRO para soldadura por pontos de parafusos, arruelas, rebites e estrelas de tração, aquecimento de chapa e estampagem.

STARTER STATIONS



COMPLETE SOLUTIONS FOR STEEL AND ALUMINIUM



STEEL

STEEL STARTER STATION



ALUMINIUM

ALU STARTER STATION

TROLLEY AMERICA
803084



KIT MULTILEVER
802442



PULLING LEVER KIT
804022



COMPACT PULLER
802599



DENT PULLING BOX
802690



STEEL STARTER STATION
804902

■

■

■

■

ALU STARTER STATION
802853

■

■

AMERICA TROLLEY

803084



OPTIONAL GENERATORS

DIGITAL PULLER 5500

DIGITAL CAR SPOTTER 5500



STEEL

MMA WELDING

MIG-MAG WELDING

TIG WELDING

PLASMA CUTTING

SPOT WELDING

CHARGING & STARTING

INDEX

PULLER STATIONS

COMPLETE SOLUTIONS FOR STEEL



STEEL

STEEL STATION



STEEL

STEEL STATION DELUXE

	PULLER STATION 803095	KIT MULTILEVER 802442	TRACTION BAR 802657	PULLING BAR 802433	LONG BAR KIT (1,5M) 802815	PULL SYSTEM 804025	MULTIHOOKS (8 PINS) 802691	(6 PINS) 802692	DENT PULLING BOX 802690
● STEEL STATION 802850	<input type="checkbox"/>	<input type="checkbox"/>	<input type="checkbox"/>	<input type="checkbox"/>	<input type="checkbox"/>	<input type="checkbox"/>	<input type="checkbox"/>	<input type="checkbox"/>	<input type="checkbox"/>
● STEEL STATION DELUXE 804901	<input type="checkbox"/>	<input type="checkbox"/>	<input type="checkbox"/>	<input type="checkbox"/>	<input type="checkbox"/>	<input type="checkbox"/>	<input type="checkbox"/>	<input type="checkbox"/>	<input type="checkbox"/>

PULLER STATION TROLLEY

803095



OPTIONAL:

HOOKS 6 PCS
803507



CABLES HOLDER KIT
804060

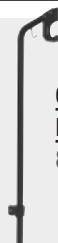

OPTIONAL GENERATORS

ALUMINIUM

PAG. 28

STEEL

PAG. 31

PULLER STATIONS



COMPLETE SOLUTIONS FOR STEEL AND ALUMINIUM



ALUMINIUM

ALUMINIUM

STEEL

ALUMINIUM

STEEL

ALU STATION DELUXE

COMBO ALU & STEEL

COMBO ALU & STEEL DELUXE

	PULLER STATION	KIT MULTILEVER	TRACTION BAR	PULLING BAR	COMPACT PULLER	LONG BAR KIT (1,5M)	PULL SYSTEM	MULTIHOOKS (8 PINS) (6 PINS)	DENT PULLING BOX	ADJUSTABLE FILE HOLDER + BODYBLADE 9TPI	ALUMINIUM HAMMERS KIT	HEAT GUN	RUBBERIZED DOLLY SET KIT
	803095 	802442 	802657 	802433 	802599 	802815 	804025 	802691 802692 	802690 	804067 	804161 	804096 	804063
● ALU STATION DELUXE 804905	■			■	■					■	■	■	■
● COMBO ALU & STEEL 802851	■	■	■		■		■	■	■				
● COMBO ALU & STEEL DELUXE 804904	■	■	■	■	■	■	■	■	■	■	■	■	■

● Bodyshop product

MMA WELDING

MIG-MAG WELDING

TIG WELDING

PLASMA CUTTING

SPOT WELDING

CHARGING & STARTING

INDEX

T-REACTION 250



NEW

BODYSHOP



SMART STRAIGHTENING FOR STEEL & ALU



WATCH THE VIDEO

STEEL STRUCTURE TO AVOID DEFORMATIONS

250 KG TRACTION FORCE WITH ADJUSTABLE HEIGHT

WORKS WITH COMPRESSED AIR



EASY TO MOVE ON WHEELS

OPTIONAL

6 PIN MULTIHOOK + EYEBOLT 802700



TECHNICAL DATA

CE EAC	CODE				
		kg	bar	cm	kg
● T-REACTION 250	804930	250	6 - 8	71x63 x122	40

GREAT STABILITY AND RESISTANCE THANKS TO THE VACUUM EFFECT

EN/ Smart system for straightening external metal sheets. By using compressed air, it develops a vacuum effect which ensures perfect adhesion to the floor without the need for additional support or fixing points. The system has a manual hoist that develops a traction force of 250 kg and it's the ideal aid for straightening thin sheets through slotted washers or glue systems. Easy to install and to manoeuvre, it represents an indispensable tool for the reduction of working times in the body shop.

FR/ Système rapide de redressement de tôles extérieures. Il utilise l'air comprimé pour développer un effet ventouse qui assure une adhérence parfaite au sol sans avoir besoin de support ou points de fixation supplémentaires. Le système de levage manuel développe une force de traction de 250 kg, devenant une aide idéale pour redresser les tôles minces grâce à l'utilisation de rondelles fendues ou de systèmes à colle. Grâce à l'installation rapide et à la grande maniabilité, il représente un outil indispensable pour réduire le temps de travail dans l'atelier de carrosserie.

DE/ Schnell-System zum Richten von Außenhautblechen. Es verwendet Druckluft, die durch den Venturi-Effekt ein Vakuum erzeugt und damit eine perfekte Haftung auf dem Boden gewährleistet. Das System verfügt über eine Handratsche mit einer Zugkraft von 250 kg und ist damit ein ideales Hilfsmittel zum Richten dünner Bleche mit Langlochscheiben oder Klebepad-Systemen. Einfach zu installieren und zu manövrieren, ist es ein unverzichtbares Werkzeug zur Reduzierung der Arbeitszeiten im Karosseriebau.

IT/ Sistema rapido per la raddrizzatura di lamierati esterni. Attraverso l'uso dell'aria compressa sviluppa un effetto ventosa che ne assicura la perfetta adesione al pavimento senza bisogno di ulteriori punti di appoggio o fissaggio. Il sistema a paranco manuale sviluppa una forza di trazione di 250 kg diventando un aiuto ideale per la raddrizzatura di lamierati sottili attraverso l'utilizzo di rondelle asolate o sistemi a colla. Grazie alla rapidità di installazione e alla grande manovrabilità, rappresenta uno strumento indispensabile per la riduzione dei tempi di lavoro in carrozzeria.

ES/ Sistema rápido de redressement de tôles extérieures. Il utilise l'air comprimé pour développer un effet ventouse qui assure une adhérence parfaite au sol sans avoir besoin de support ou points de fixation supplémentaires. Le système de levage manuel développe une force de traction de 250 kg, devenant une aide idéale pour redresser les tôles minces grâce à l'utilisation de rondelles fendues ou de systèmes à colle. Grâce à l'installation rapide et à la grande maniabilité, il représente un outil indispensable pour réduire le temps de travail dans l'atelier de carrosserie.

PT/ Sistema rápido para endireitar chapa metálica externa. Utiliza ar comprimido para desenvolver um efeito otário que garante perfeita aderência ao piso sem a necessidade de suportes adicionais ou pontos de fixação. O sistema de elevação manual desenvolve uma força de tração de 250 kg, tornando-se uma ajuda ideal para endireitar chapas finas através do uso de arruelas com fenda ou sistemas de cola. Graças à rápida instalação e de grande manobrabilidade, representa uma ferramenta indispensável para a redução dos tempos de trabalho em carroceria.



OVER
110
SMART
REPAIR
TOOLS

NEW

GLUE REPAIR DELUXE

804577



IN STURDY RECYCLED
PLASTIC CARRY CASE

EN/ Professional glue repair system in a sturdy recycled plastic case.

IT/ Sistema professionale per la riparazione con colla in robusta valigetta di plastica riciclata.

FR/ Système professionnel de réparation avec de la colle dans un mallette en plastique recyclé solide.

ES/ Sistema profesional de reparación con pegamento en una resistente maleta de plástico reciclado

DE/ Professionelles Klebstoffreparatursystem in einem robusten Koffer aus recyceltem Kunststoff.

PT/ Sistema profissional de reparação com cola em uma robusta maleta de plástico reciclado.

MMA WELDING

MIG-MAG WELDING

TIG WELDING

PLASMA CUTTING

SPOT WELDING

CHARGING & STARTING

INDEX



OVER
150 SMART
REPAIR
TOOLS

NEW



INCLUDED



SMART REPAIR TROLLEY

804593

EN/ Complete system designed for Smart Repair on trolley.

IT/ Sistema completo su carrello pensato per lo smart repair.

FR/ Système complet pour le Smart Repair sur chariot.

ES/ Sistema completo para Smart Repair en carrito.

DE/ Komplettes System auf einem Wagen für Smart-Repair konzipiert.

PT/ Sistema completo para Smart Repair em carrinho.

GLUE REPAIR DELUXE - SMART REPAIR TROLLEY



SMART REPAIR SYSTEMS

DESCRIPTION		PCS	GLUE REPAIR DELUXE 804577	SMART REPAIR TROLLEY 804593	CODE
GLUE TABS VENTOSE PATTES DE COLLAGE LENGÜETAS PEGAMENTO KLEBEPAD VENTOSAS	Angular · Angolari · Angulaire · Angular · Winkelkopf · Angulares	2	■	■	804550
	Rectangular · Rettangolari · Rectangulaires · Rectangulares · Rechteckiger · Rectangulares	6	■	■	804551
	Circular · Circolari · Circulaires · Circulares · Kreisförmig · Circulares	2	■	■	804552
	Spheric · Sferiche · Sphériques · Esféricas · Rund · Esféricas	3	■	■	804553
	Multi Shape · Multi-Formi · Multiforme · Multifor · Multiform · Multiformas	24	■	■	804557
	EXTENDED · ESTESE · ÉTENDUES · EXTENDIDAS · ERWEITERTES · ESTENDIDAS				
	Multi Shape · Multi-Formi · Multiforme · Multifor · Multiform · Multiformas	10	■	■	804554
	Rectangular · Rettangolari · Rectangulaire · Rectangular · Rechteckiger · Rectangulares	6	■	■	804558
	HOOKS · GANCIO · CROCHET · GANCHOS · HAKEN · GANCHO				
	Double · Doppio · Double · Dobles · Doppel · Duplo		■ 2	■ 1	804555
	Multi Point · Multi Gancio · Multi-Crochets · Multigancho · Multi-Haken · Multiganchos	3	■	■	804556
	MULTI APPLICATION · APPLICAZIONE MULTIPLA · MULTI-APPLICATIONS · APLICACIÓN MÚLTIPLE · MEHRFACHANWENDUNG · MULTIAPLICAÇÃO				
	A	7		■	804562
	B	6		■	804563
EYE BOLT · Golfare · Boulon Oeil · Perno De Ojo · Ringschraube · Olhal	2	■	■	232113	
DRAWER 2					
KIT TEFLON WEDGES · Kit cunei in teflon · Kit cales en téflon · Kit de cuñas de teflón · Teflonkeil-Set · kit calços teflon	10		■		
Glue Scraper · Spatola Rimuovi Colla · Spatule Pour Colle · Espatula Para Pegamento · Spachtel Für Klebstoff · Raspador De Cola			■		
DOLLIES · TASSELLI TASSEAUX · TACOS EINSATZSTÜCKEN BUCHAS	Curved	1		■	
	Heel	1		■	
	Long Heel	1		■	
HAMMER MARTELLI MARTEAUX MARTILLOS HAMMER MARTELOS	Aluminum · Alluminio · Aluminium · Aluminio · Aluminium · Alumínio	1	■	■	
	Tip Kit · Kit Puntali · Marteau Tip · Kit De Puntas · Richtkonus-Set · Kit De Ponteiros	9	■	■	
	Small · Piccolo · Petit · Pequeño · klein · Pequeno	1		■	
	Regular · Regolare · Régulier · Regular · Regulär · Regular	1		■	
DRAWER 3					
MULTIHOOK MULTIGANCIO MULTICROCHET MULTIGANCHO AUSBEULKRALLE GARRAS DE TRACÃO	10 Pin	1		■	802696
	6 Pin	1		■	802692
	3 Pin	1		■	742283
ADJUSTABLE FILE HOLDER + BODYBLADE 9TPI · Porta Lima Regolabile + Lima 9tpi · Porte-Lime Réglable + Lime 9tpi · Soporte Lima Regulable + Lima 9tpi · Einstellbarer Feilenhalter + Feile 9tpi · Porta-Lima Ajustável + Lima 9tpi	1		■	■	804067
Empty boxes	2		■		
DRAWER 4					
PDR G-SU.RE HOT GLUE REMOVER SPRAY · Spray Rimuovi Colla A Caldo · Spray D'elimination De Colle · Spray Para Eliminar Cola · Schmelzklebstoffentfernerspr · Removedor De Cola	1		■	■	804561
GG150 GLUE GUN	1		■	■	804978
HEAT GUN · Pistola Termica · Pistolet Thermique · Pistola Térmica · Thermische Pistole · Pistola Térmica	1			■	
DIGITAL THERMOMETER · Termometro Digitale · Thermomètre Numérique · Termómetro Digital · Digitalthermometer · Termómetro digital	1			■	804980
GLUE · COLLA COLLE · PEGA KLEBE · COLA	TELFIX · Elastic		■ 10 pcs	■ 1kg	804602
	TELFIX · Strong		■ 10 pcs	■ 1kg	804603
DRAWER 5					
GLUE EXTRACTOR · Martello Estrattore Per Ventose · Extracteur De Colle · Extractor De Pegamento · Ausziehhammer Für Klebe-Pads-Martelo · Extractor Para Ventosa	1		■	■	
COMPACT GLUE PULLER · Estrattore Compatto · Compact Extracteur De Colle · Extractor De Cola Compacto · Mini-Puller Für Klebe-Pads · Extractor Compacto/Manual	1		■	■	804560
DENT REPAIR CORDLESS LED LAMP · Lampada Led Rileva Ammacature Cordless · Lampe Á Led De Debosselage Sans Fil · Lámpara Led Detecta Abolladuras Sincable · Ausbeulen Kabellose Led-Lampe · Lámpada LED sem fio para reparo de dentes	1			■	804455

GLUE TABS

GLUE TABS - VENTOSE - PATTES DE COLLAGE - LENGÜETAS PEGAMENTO - KLEBEPAD - VENTOSAS

ANGULAR - YELLOW

ANGULAR - ANGOLARI - ANGULAIRE
- ANGULAR - WINKELKOPF - ANGULARES
804550

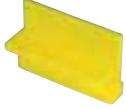

RECTANGULAR - RED

RECTANGULAR - RETTANGOLARI
- RECTANGULAIRE - RECTANGULAR
- RECHTECKIGER - RECTANGULARES

804551 - 6pcs



CIRCULAR BLUE

CIRCULAR - CIRCOLARI - CIRCULAIRE
- CIRCUL - KREISFÖRMIG - CIRCULARES
804552 - 2pcs



SPHERIC RED

SPHERIC - SFERICHE - SPHÉRIQUE -
ESFÉRICA - KUGELFÖRMIG - ESFÉRICAS
804553 - 3pcs



MULTI SHAPE PURPLE

MULTI SHAPE - MULTI-FORMI - MULTIFORME - MULTIFOR - MULTIFORM - MULTIFORMAS
804557 - 24pcs

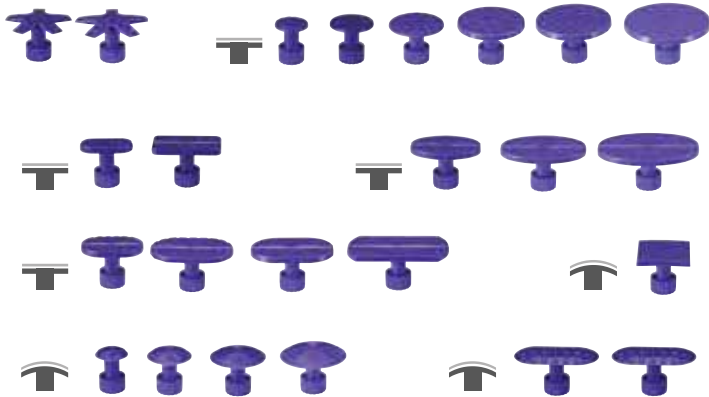

EXTENDED MULTI SHAPE

ESTESE MULTI-FORMI - ÉTENDUES MULTIFORME - EXTENDIDAS MULTIFOR
- ERWEITERTES MULTIFORM - ESTENDIDAS MULTIFORMAS
804554 - 10pcs

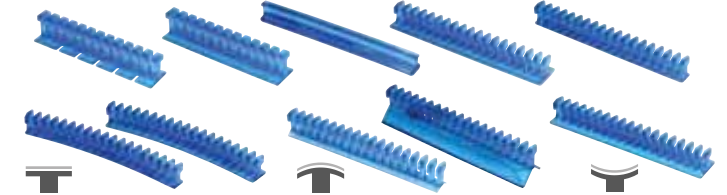

EXTENDED RECTANGULAR

EXTENDED RECTANGULAR - ESTESE RETTANGOLARI - ÉTENDUES RECTANGULAIRE -
EXTENDIDAS RECTANGULAR - ERWEITERTES RECHTECKIGER - ESTENDIDAS
RECTANGULARES

804558 - 6pcs



MULTI APPLICATION A

MULTI APPLICATION - APPLICAZIONE MULTIPLA - MULTI-APPLICATIONS - APLICACIÓN
MÚLTIPLE - MEHRFACHANWENDUNG - MULTIAPLICAÇÃO

804562 - 7pcs



MULTI APPLICATION B

MULTI APPLICATION - APPLICAZIONE MULTIPLA - MULTI-APPLICATIONS - APLICACIÓN
MÚLTIPLE - MEHRFACHANWENDUNG - MULTIAPLICAÇÃO

804563 - 7pcs



DOUBLE HOOKS

DOPPIO GANCIO - DOUBLE CROCHET - GANCHOS DOBLES - DOPPELHAKEN -
GANCHO DUPLO

804555 - 6pcs



MULTI POINT HOOK

MULTI GANCIO - MULTI-CROCHETS - MULTIGANCHO - MULTI-HAKEN - MULTIGANCHOS

804556 - 18pcs



TELFIX GLUE

COLLA - COLLE - PEGA - KLEBE - COLA

ELASTIC

804602 - 1KG

2

6°C ÷ 39°C



STRONG

804603 - 1KG

2

6°C ÷ 39°C



DIGITAL THERMOMETER

TERMOMETRO DIGITALE • THERMOMÈTRE NUMÉRIQUE • TERMÓMETRO DIGITAL • DIGITALTHERMOMETER • TERMÔMETRO DIGITAL

804980

-50°C ÷ +500°C



COMPACT GLUE PULLER

ESTRATTORE COMPATTO • COMPACT EXTRACTEUR DE COLLE • EXTRACTOR DE COLA COMPACTO • MINI-PULLER FÜR KLEBE-PADS • EXTRACTOR COMPACTO/MANUAL

804560

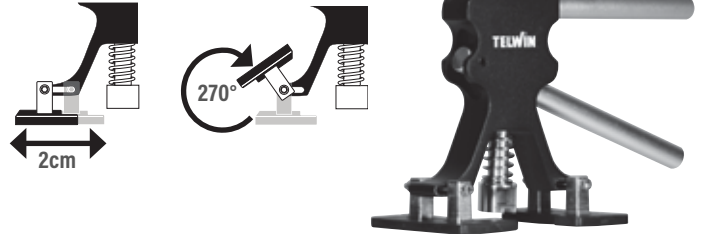

GG150 GLUE GUN

804978

ADJUSTABLE UP TO 220°C MAX

90°
READY



CORDLESS
LI-ION 18V
BATTERY

HEAT GUN

PISTOLA TERMICA • PISTOLET THERMIQUE • PISTOLA TÉRMICA • THERMISCHE PISTOLE • PISTOLA TÉRMICA

804096

230V ~ 50HZ 1PH

350°C ÷ 600°C



PDR G-SU.RE HOT GLUE REMOVER SPRAY

SPRAY RIMUOVI COLLA A CALDO • SPRAY D'ELIMINATION DE COLLE • SPRAY PARA ELIMINAR COLA • SCHMELZKLEBSTOFFENTFERNERSPR • REMOVEDOR DE COLA

804561

- PROFESSIONAL USE
- QUICK & EFFECTIVE
- IDEAL FOR P.D.R.



BODY REPAIR HAMMER

MARTELO PER CARROZZERIA • MARTEAU DE RÉPARATION DE CARROSSERIE • MARTILLO DE REPARACIÓN DE CARROCEÍA • KAROSSERIE-REPARATURHAMMER • MARTELO PARA CARROCEIA

804575



GLUE SCRAPER

SPATOLA RIMUOVI COLLA • SPATULE POUR COLLE • ESPATULA PARA PEGAMENTO • SPACHTEL FÜR KLEBSTOFF • RASPADOR DE COLA

321031



DENT REPAIR CORDLESS LED LAMP

804455

EN/ It helps to identify the dents on the bodywork.
IT/ Aiuta ad individuare le ammaccature sulla carrozzeria.
FR/ Il permet d'identifier les bosses sur la carrosserie.
ES/ Ayuda a identificar las abolladuras en la carrocería.
DE/ Es hilft, die Beulen an der Karosserie zu identifizieren.
PT/ Ajuda a identificar as mossas na carroçaria.

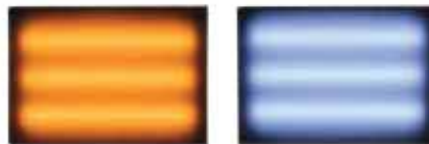

2 colours-dimmable lights (hot-cold)



Rechargeable lithium battery

OTHER ACCESSORIES

RUBBERIZED DOLLY SET KIT

804063



TEFLON WEDGES KIT

804068



ADJUSTABLE FILE HOLDER + BODYBLADE 9TPI

804067

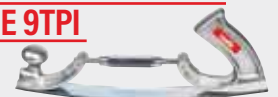

DENT PULLING ACCESSORIES



C STUDDER READY BOX

143722



D STUDDER BOX

143780



E DENT PULLING BOX

802690



F DENT PULLING CONSUMABLES KIT

802838



LEGENDA:



DESCRIPTION

For order of single code
Per ordini di codici singoli





	3,2 mm	802297 (100 pcs)	D 50 PCS
---	--------	---------------------	--------------------

Quantity inside box
Pezzi nella scatola

STARS · STELLE · ÉTOILES · ESTRELLAS · STERN · ESTRELAS

	PULLING STARS	802296 (100 pcs)	C 10 PCS D 10 PCS E 20 PCS F 20 PCS
	STAR HOLDING ELECTRODE	722954	

WAVY WIRE · FILO ONDULATO · FIL ONDULEE · HILO ONDULATO · WELLDRAHT · FIO ONDULADO

	300 mm	802339 (50 pcs)	F 20 PCS
	200 mm	802728 (50 pcs)	E 20 PCS
	SPOT WELDING ELECTRODE	742485	D 1 PC E 1 PC
	MAGNETIC POSITIONER	742087	





WASHERS · RONDELLE · RONDELLES · ARANDELAS · SCHEIBEN · ARRUELAS

	Ø 8 mm	802295 (100 pcs)	C 50 PCS D 50 PCS
	WASHERS HOLDING ELECTRODE	742484	C 1 PCS D 1 PCS
	HOOK MANDREL	722955	

UPSETTING · RICALCATURA · REBATTAGE · RECALCADO · RÜCKVERFORMUNG · ESTAMPAGEM

	SQUEEZING ELECTRODE	722963	C 1 PCS D 1 PCS
---	---------------------	--------	--

RIVETS · RIVETTI · RIVETS · REMACHES · NIETEN · REBITES

Ø 3			
	3,2 mm	802297 (100 pcs)	D 50 PCS
	4,5 mm	802298 (100 pcs)	D 100 PCS
	ELECTRODE	742484	D 1 PCS
M4			
	15 mm	802300 (100 pcs)	
	ELECTRODE	722958	

HOOK WASHERS · RONDELLE ASOLATE · RONDELLES ANNEAUX · ARANDELAS CON GANCHO · HAKENSCHLEIBEN · ANILHAS DE GANCHO

	FLAT HOOK WASHERS	802943 (50 pcs)	E 10 PC F 50 PCS
	TWISTED HOOK WASHERS	802944 (50 pcs)	E 10 PC F 20 PCS
	ELECTRODE	742541	E 1 PC
	210 mm LEVER	484244	E 1 PC
	410 mm LEVER	484635	

M5 - Ø 5

	18 mm	802301 (100 pcs)	D 50 PCS
	10 mm	802299 (100 pcs)	
	12 mm	802302 (100 pcs)	D 50 PCS
	25 mm	802304 (100 pcs)	
	ELECTRODE M5 - M6	722959	D 1 PC

SPOT-WELDING 1 SIDE · PUNTATURA 1 LATO · POINTEAGE 1 CÔTÉ · SOLDADURA 1 LADO · EINSEITIGES PUNKTSCHWEISSEN · SOLDADURA PONTOS 1 LADO

	ELECTRODE	742485	D 1 PCS
---	-----------	--------	-------------------

SPOT WELDING EARTH · MASSA A PUNTARE · MASSE DE POINTEAGE · MASA PARA PUNTEADO · MASSE FÜR PUNKTSCHWEISSEN · MASSA PARA PONTOS

		802462	
---	--	--------	--

HEATING · RISCALDAMENTO · RETREINTE · CALENTAMIENTO · ERHITZUNG · AQUECIMENTO

	150 mm CARBON	802608 (5 pcs)	C 1 PCS D 1 PCS
---	---------------	-------------------	--

NAILS · CHIODI · CLOUS · CLAVOS · STIFTE · PREGOS

	Ø 2x50 mm	802293 (100 pcs)	
	Ø 2,6x50 mm	802294 (100 pcs)	
	NAILS HOLDING ELECTRODE	742486	
	NAIL HOLDER	722953	

DENT PULLING ACCESSORIES



PULLING BARS

BARRE DI TRAZIONE • BARRES DE TRACTION • BARRAS DE TRACCIÓN • HERAUSZIEHEN STANGE • BARRAS DE TRACÇÃO

PULLING BAR

802433



STANDARD BAR 0.9m
OPTIONAL BAR 1.5m
802815

OPTIONAL:

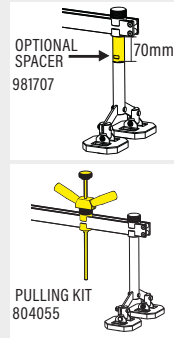

TRACTION BAR

802657



STANDARD BAR 0.9m
OPTIONAL BAR 1.5m

KIT MULTILEVER

802442



OPTIONAL:



MULTIHOOKS

MULTIGANCIO • MULTICROCHET • MULTIGANCHO • AUSBEULKRALLE • GARRAS DE TRACÇÃO

802696 (10 pins) 802691 (8 pins) 802692 (6 pins) 742283 (3 pins)



EXTRACTORS

ESTRATTORI • EXTRACTEURS • EXTRACTORES • EXTRAKTOREN • EXTRATORES

722952



OPTIONAL:



MAXI EXTRACTOR

802451



RAPID SPOT

802461



OPTIONAL:

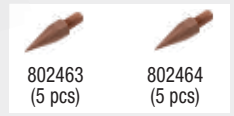

SPOT WELDING EARTH

MASSA A PUNTARE
MASSE POUR POINTAGE
MASA PARA PUNTEADO
SCHWEISSBARE MASENBUCHSE
MASSA PARA PONTOS
802462



POSITIONER FOR WAVY WIRE

POSIZIONATORE MAGNETICO X FILO ONDULATO
POSITIONNEUR POUR FIL ONDULEE
POSICIONADOR PARA HILO ONDULATO
STELLWERK FÜR WELIG DRAHT
POSICIONADOR PARA FIO ONDULADO
742087



COMPACT PULLER

802599



COMPLETE WITH HOOKS



PULL SYSTEM

804025



OPTIONAL:

Round headed electrode (5pcs) 802445
Tip headed electrode (5pcs) 802444
Squeezing electrode 742331

AUTOMOTIVE WELDING CLAMPS

802627



802586



GLUE PULLER KIT

802660



INCLUDED

COMPACT PULLER 802599

SUCKER HEAD 742528

EXTRACTOR'S ADAPTOR M10 - M14 742529

SUCKER PACKAGE (20 pcs)

THERMOGLUE GUN 322956

WEDGE 322956

GLUE PACKAGE (10 pcs)

SPATULA 321031

OPTIONAL:

SUCKERS:

Ø 11 mm 10 pcs 802641
Ø 16 mm 10 pcs 802642
Ø 21 mm 10 pcs 802643
Ø 32 mm 10 pcs 802644

GLUE STICKS:

10 pcs 802735

MMA WELDING

MIG-MAG WELDING

TIG WELDING

PLASMA CUTTING

SPOT WELDING

CHARGING & STARTING

INDEX

HOT STAPLER PLASTIC REPAIR

SALDATORE PER PLASTICA CON GRAFFETTE A CALDO • SOUDEUR POUR PLASTIQUE AVEC AGRAFES À CHAUD • SOLDADOR PARA PLÁSTICO CON GRAPAS EN CALIENTE
• PLASTIKSCHWEISSGERÄT MIT KLAMMERN FÜR HEISSARBEITEN • KIT REPARAÇÃO DE PLÁSTICOS A QUENTE

804159

- Makes solid, permanent repairs of breaks, cracks and tears in rigid or flexible plastic parts
- Easy-to-use tool for quick and efficient repairing

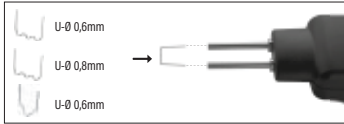

INCLUDED

- plastic carry case
- 50pcs flat staples Ø 0,6mm
- 50pcs flat staples Ø 0,8mm
- 50pcs inside corner staples Ø 0,6mm
- 230V charger

LIGHT AND PORTABLE

LITHIUM BATTERIES



CONSUMABLES:

FLAT STAPLES KIT

- Ø 0,6mm 100pcs 804075
- Ø 0,8mm 100pcs 804076

WAVE STAPLES KIT

- Ø 0,6mm 100pcs 804077
- Ø 0,8mm 100pcs 804078

INSIDE CORNER STAPLES KIT

- Ø 0,8mm 100pcs 804079

OUTSIDE CORNER STAPLES KIT

- Ø 0,6mm 100pcs 804080



RUBBERIZED DOLLY SET KIT (7PCS)

KIT TASSELLI RIVESTITI IN GOMMA • KIT TASSEUX REVÊTUS DE GOMME • KIT DE TACOS REVESTIDOS DE GOMA
• SET AUS MIT GUMMI VERKLEIDETEN EINSATZSTÜCKEN • KIT TAIS REVESTIDOS A BORRACHA

804063



- Ideal for aluminium and steel work
- Less bounce back than steel dollies
- The steel core in each dolly has a dense rubber covering that absorbs the harsh impacts.
- 7 pieces of rubberized dollies in a moulded carry case



HEAT GUN

PISTOLA TERMICA • PISTOLET THERMIQUE • PISTOLA TÉRMICA • THERMISCHE PISTOLE • PISTOLA TÉRMICA

804096

230V ~ 50HZ 1PH



Digital temperature control

TEFLON WEDGES KIT (10PCS)

KIT CUNEI IN TEFLON • KIT CALES EN TÉFLON • KIT DE CUÑAS DE TEFLÓN • TEFLONKEIL-SET • KIT CALÇOS TEFLON

804068

- Tools for dent removal without damaging paint.
- 2 handles, 6 interchangeable attachments in a plastic carry case



ADJUSTABLE FILE HOLDER + BODYBLADE 9TPI

PORTA LIMA REGOLABILE + LIMA 9TPI • PORTE-LIME RÉGLABLE + LIME 9TPI
• SOPORTE LIMA REGULABLE + LIMA 9TPI • EINSTELLBARER FEILENHALTER + FEILE 9TPI
PORTA-LIMA AJUSTÁVEL + LIMA 9TPI

804067



MAGNETIC TAPS DOWN

PUNTALI MAGNETICI • POINÇONS MAGNETIQUES
• PUNTAS MAGNÉTICAS • MÁGNETSPITZEN • PUNÇÃOS MAGNÉTICO

804070

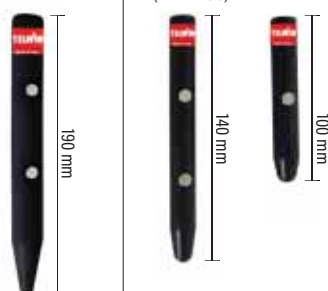

804071
(KIT 2 PCS)

RUBBER HAMMERS KIT (3PCS)

KIT MARTELLI IN GOMMA • KIT MARTEAUX EN GOMME • KIT DE MARTILLOS DE GOMA • GUMMIHAMMER-SET • KIT MARTELOS EM BORRACHA

804066



ALUMINIUM HAMMERS KIT (3PCS)

KIT MARTELLI IN ALLUMINIO • KIT MARTEAUX EN ALUMINIUM • KIT DE MARTILLOS DE ALUMINIO
• ALUMINIUMHAMMER-SET • KIT MARTELOS EM ALUMÍNIO

804161



IN PLASTIC CARRY CASE

DIGITAL SPOTTER 7000 - DIGITAL SPOTTER 9000 AQUA



ONE TOUCH

PULSE GALVANISED

0.8 mm

Set the thickness and start working!

DIGITAL SPOTTER 9000 AQUA
823196
+ OPTIONAL POLE & BALANCER



AQUA

STANDARD



OPTIONAL

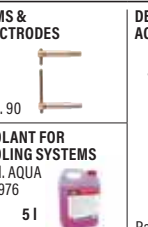
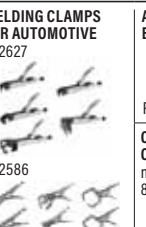

TECHNICAL DATA

CE EAC	CODE	V _{2PH} V (50-60Hz)	A _{OUT} A	V ₀ V	P _{MAX} kW	P _{50%} kW	Ø	mm	DUTY CYCLE %	IP	LxWxH cm	kg
DIGITAL SPOTTER 7000	823198	400 2 ph	4500	8,6	27,3	6,7	0,7	1,5 + 1,5	3	IP22	52 x 38 x 88,5	50
DIGITAL SPOTTER 9000	823195	400* 2 ph	7000	10	47	8	0,8	3 + 3	3	IP22	79 x 45 x 90	78
DIGITAL SPOTTER 9000 AQUA*	823196	400* 2 ph	7000	10	47	11	0,8	3 + 3	5	IP22	79 x 45 x 90	95

(*) AQUA = Water cooled - Raffreddata ad acqua - Refroidie à l'eau - Refrigerada por agua - Wassergekühlte - Refrigerada por água

(*) = 208-230V Mains power on request - Alimentazione a richiesta - Alimentation sur demande - Alimentación a requerimiento - Stromversorgung auf Anfrage - Alimentação elétrica a pedido

EN/ Electronic spot-welding machines suitable. Features: automatic identification of the tool - automatic control of the clamp and cable cooling (mod. 9000) - choice of optimal spot-welding current according to mains power - studder functions. Digital Spotter 9000 AQUA: equipped with water cooled pneumatic gun and water cooling unit.

IT/ Saldatrici a resistenza (puntatrici) elettroniche. Caratteristiche: riconoscimento automatico dell'utensile inserito - controllo automatico del raffreddamento della pinza e dei cavi (mod. 9000) - scelta della corrente di puntatura ottimale in funzione della potenza di rete disponibile - funzioni studder. Digital Spotter 9000 AQUA: completa pinza pneumatica raffreddata ad acqua e gruppo raffreddamento ad acqua.

FR/ Postes de soudage par points, électroniques. Caractéristiques: reconnaissance automatique de l'outil monté - contrôle automatique du refroidissement de la pince et des câbles (mod. 9000) - sélection du courant de soudage adapté en fonction de la puissance de réseau disponible - fonctions studder. Digital Spotter 9000 AQUA : fourni avec pince pneumatique refroidie à eau et groupe de refroidissement eau.

ES/ Soldadoras por puntos electrónicas. Características: identificación automática de la herramienta introducida - control automático del enfriamiento de la pinza y de los cables (mod. 9000) - elección de la corriente óptima de soldadura según la potencia de red disponible - funciones studder. Digital Spotter 9000 AQUA: equipada con pinza neumática refrigerada por agua y equipo de refrigeración por agua.

DE/ Mikroprozessorgesteuerte, elektronische, Punktschweißgeräte. Eigenschaften: Automatische Erkennung des eingesetzten Werkzeugs - automatisch gesteuerte Kühlung von Zange und Kabeln (Mod. 9000) - Wahl des optimalen Punktschweißstroms nach der bereitgestellten Netzleistung - Studder Funktionen. Digital Spotter 9000 AQUA: komplett mit wassergekühlter pneumatischer Zange und Wasserkühlungseinheit.

PT/ Aparelhos eletrónicos de soldadura por pontos. Características: identificação automática da ferramenta - controlo automático da refrigeração do grampo e cabo (mod. 9000) - escolha da corrente de soldadura mais adequada em função da rede elétrica - funções studder. Digital Spotter 9000 AQUA: equipado com pistola pneumática com refrigeração a água e unidade de refrigeração a água.

MMA WELDING

MIG-MAG WELDING

TIG WELDING

PLASMA CUTTING

SPOT WELDING

CHARGING & STARTING

INDEX

POWER GUN TECHNOLOGY



EN/ Wide range of operation by means of longer (5m) and lighter cables, in comparison with traditional ones, high power in the clamp, excellent ease of handling thanks to the transformer inside the clamp, electromagnetic fields (EMF) certified safety.

IT/ Elevato campo d'azione con cavi più lunghi (5m) e più leggeri di quelli tradizionali, elevate potenze nella pinza, massima maneggevolezza grazie al trasformatore in pinza, sicurezza certificata per i campi elettromagnetici EMF.

FR/ Champ d'action élevé avec câbles plus longs (5m) et plus légers que les câbles traditionnels, puissances élevées dans la pince, grande facilité de manipulation grâce au transformateur dans la pince, sécurité pour les champs électromagnétiques EMF.

ES/ Elevado campo de acción con cables más largos (5m) y más livianos que los cables tradicionales, potencias elevadas en la pinza, máxima manejabilidad gracias al transformador en la pinza, seguridad certificada para los campos electromagnéticos EMF.

DE/ Hohe Betriebsbereich durch länger (5m) und leichter Kabel als herkömmliche Kabel, hohe Leistungswerte in der Zange, beste Handhabung dank des in die Zange integrierten Transformators, bescheinigte Sicherheit im Rahmen der EMF elektromagnetischen Felder.

PT/ Alto raio de alcance com cabos mais longos (5m) e mais leves do que os convencionais, alta potência na braçadeira, máximo manuseamento graças ao transformador na braçadeira, segurança certificada EMF.

WIDE APPLICATIONS IN CAR BODY REPAIR

EN/ Improved effectiveness during interventions thanks to specific water-cooled arms, up to 635 mm long.

IT/ Migliore operatività negli interventi grazie a bracci specifici raffreddati ad acqua, fino a 635 mm.

FR/ Meilleure opérationnalité dans les interventions grâce à des bras spéciaux refroidis par eau, jusqu'à 635 mm.

ES/ Mejor operatividad en las intervenciones, gracias a brazos específicos refrigerados con agua, de hasta 635 mm de longitud.

DE/ Bessere Arbeitsbedingungen dank der speziellen, wassergekühlten Arme, die bis zu 635 mm lang sein können.

PT/ Melhoria da operacionalidade em intervenções graças a braços específicos arrefecidos a água, até 635 m.

SHARK
803189

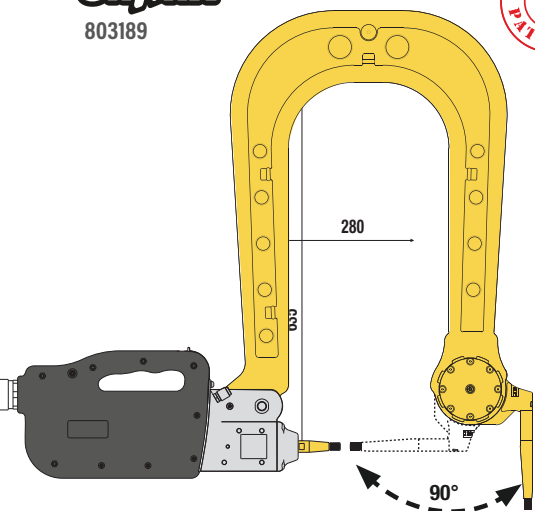

OPENING



INSERTING



SPOT WELDING

EN/ Shark A7 is a revolutionary arm designed to speed up and simplify spot welding operations in the most difficult to access areas. Thanks to the patented "large opening" mechanism, the end section of the Shark A7 opens 90° by simply pressing with your finger, even allowing insertion in boxed or difficult to reach parts.

IT/ Shark A7 è il rivoluzionario braccio ideato per velocizzare e semplificare le operazioni di puntatura nelle zone di più difficile accesso. Grazie al meccanismo brevettato di "grande apertura", la sezione terminale di Shark A7 si apre di 90° con una semplice pressione del dito, permettendone l'inserimento anche in parti scatolate o difficilmente raggiungibili.

FR/ Shark A7 est le bras révolutionnaire pensé pour accélérer et simplifier les opérations de soudage par points dans les zones les plus difficiles d'accès. Grâce au mécanisme breveté de « grande ouverture », la section terminale de Shark A7 s'ouvre de 90° par une simple pression du doigt, ce qui en permet l'insertion même dans des parties encastrées ou difficiles à atteindre.

ES/ Shark A7 es el revolucionario brazo ideado para hacer más rápidas y sencillas las operaciones de soldadura por puntos en las zonas con un acceso más difícil. Gracias al mecanismo patentado de "gran apertura", la sección terminal de Shark A7 se abre 90° con una simple presión del dedo, y puede introducirse también en partes tapadas o difíciles de alcanzar.

DE/ Der bahnbrechende Arm Shark A7 wurde entwickelt, um die Punktschweißarbeiten von schwer zugänglichen Bereichen schneller durchführen zu können und diese zu erleichtern. Durch den patentierten Mechanismus „große Öffnung“ öffnet sich der letzte Abschnitt von Shark A7 um 90° durch ein einfaches Andrücken des Fingers, sodass sogar ein Einführen in kastenförmige oder schwer zugängliche Bereiche ermöglicht wird.

PT/ O Shark A7 é o braço revolucionário concebido para acelerar e simplificar as operações de perfuração em zonas de difícil acesso. Graças ao seu mecanismo patentado de "grande abertura", a secção final do Shark A7 abre a 90° com uma simples pressão do dedo, permitindo a sua inserção mesmo em peças embaladas ou de difícil acesso.

SMART AUTOSET



EN/ The Made-in-Telwin technology, SMART AUTOSET allows the automatic detection of both material and thickness, without manual settings and/or reference tables.

IT/ La tecnologia SMART AUTOSET Made in Telwin rileva automaticamente il tipo e lo spessore dei materiali da saldare senza regolazioni manuali e/o tabelle di riferimento.

FR/ La technologie SMART AUTOSET Made in Telwin détecte automatiquement le type et l'épaisseur des matériaux à souder sans réglages manuels et/ou tableaux de référence.

ES/ La tecnología SMART AUTOSET Made in Telwin detecta automáticamente el tipo y el espesor de los materiales a soldar sin regulaciones manuales y/o las tablas de referencia.

DE/ Die Technologie SMART AUTOSET - Made in Telwin - erkennt automatisch die Art und Stärke der Schweißwerkstoffe ohne manuellen Einstellungen und/oder Richtttabellen.

PT/ A tecnologia SMART AUTOSET da Telwin detecta automaticamente o tipo e espessura dos materiais a soldar sem ajustes manuais e/ou tabelas de referência.

WELDING DATA AVAILABLE BY USB PORT



EN/ Possibility of transferring all data on a USB key or on PC for storing, processing or printing and for software updating. Applicable also on new materials.

IT/ Possibilità di trasferire tutti i dati su una chiavetta USB o su PC per memorizzazione, elaborazione o stampa, aggiornamenti software, operatività su nuovi materiali.

FR/ Possibilité de transférer toutes les données sur une clé USB ou sur PC pour mémorisation, élaboration ou impression, mises à jour de logiciel, opérationnalité sur de nouveaux matériaux.

ES/ Posibilidad de transferir todos los datos a una llave USB o a un PC para la memorización, el procesamiento o la impresión, las actualizaciones software, la operatividad con nuevos materiales.

DE/ Möglichkeit zum Überspielen sämtlicher Daten auf USB-Stick oder PC zwecks Speicherung, Verarbeitung oder Ausdruck, Software-Update und damit einhergehend die Anpassung an neu entwickelte Materialien.

PT/ Possibilidade de transferir todos os dados para uma pen USB ou PC para armazenamento, processamento ou impressão, atualizações de software, funcionamento em novos materiais.



MULTIPLE MODES



SMART AUTO

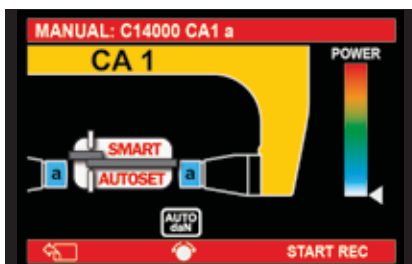

EN/ automatic detection of the thickness and the material to be welded

IT/ rilevamento automatico dello spessore e del materiale da puntare

FR/ détection automatique de l'épaisseur et du matériau à souder

ES/ detección automática del espesor y del material a soldar

DE/ automatische Erkennung der Dicke und des zu verwendetes Materials

PT/ Detecção automática de espessura e do material a ser soldado

EASY

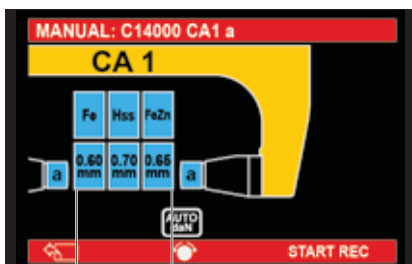

UP TO 3 DIFFERENT MATERIALS AND THICKNESSES

EN/ manual setting of up to three materials and up to three thicknesses different from one another

IT/ impostazione manuale fino a tre materiali e fino a tre spessori diversi tra loro

FR/ réglage manuel jusqu'à trois matériaux et jusqu'à trois épaisseurs différentes

ES/ ajuste manual hasta tres materiales y hasta tres espesores diferentes

DE/ manuelle Einstellung bis zu drei Materialien und bis zu drei verschiedenen Dicken

PT/ Configuração manual de até três materiais e espessuras diferentes

MANUAL

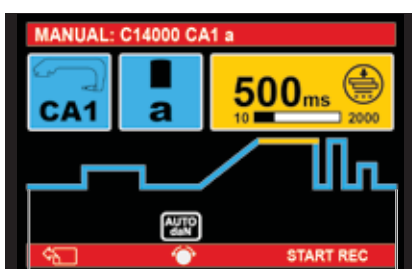

13 CUSTOMIZABLE PARAMETERS

EN/ customization of the parameters to create your own spot welding program

IT/ personalizzazione dei parametri per creare il proprio programma di puntatura

FR/ personnalisation des paramètres pour créer votre propre programme de soudage

ES/ personalización de los parámetros para crear su propio programa de soldadura

DE/ Personalisierung der Parameter, um ein individuelles Schweißprogramm einzustellen

PT/ Personalização de parâmetros para criar o seu próprio programa de soldadura por pontos



AN INNOVATIVE TOOL THAT INCREASES THE SPEED AND EFFICIENCY OF EVERYDAY BODY SHOP WORK.



QANTUM EFFICIENCY IN THE BODY SHOP



EN/ Qantum is the ideal tool for complete management of the car repair process, from acceptance to final delivery of the vehicle.

IT/ Qantum è lo strumento ideale per la gestione completa del processo di riparazione, dall'accettazione alla riconsegna del veicolo.

FR/ Qantum est l'instrument idéal pour gérer tout le processus de réparation, de la réception en atelier à la livraison du véhicule.

ES/ Qantum es el instrumento ideal para la gestión completa del proceso de reparación, desde la aceptación a la devolución del vehículo.

DE/ Qantum das ideale Werkzeug zum Managen des gesamten Reparaturvorgangs, von der Annahme bis hin zur Übergabe des Fahrzeugs.

PT/ Qantum é a ferramenta ideal para a gestão completa do processo de reparação, desde a aceitação até à devolução do veículo.

THE ADVANTAGES

SPEED

EN/ Qantum allows the user to swiftly enter the vehicle details. The integrated scanner automatically reads the VIN (Chassis Number) and car registration plate. Photos taken with smartphones and tablets are instantly archived by the App. Managing repair work formalities has never been so quick and easy!

IT/ Qantum consente di inserire velocemente le informazioni del veicolo. La funzione scanner integrata, acquisisce automaticamente VIN (Numero di Telaio) e targa dell'auto. Le foto scattate da smartphone e tablet diventano immediatamente allegati archiviati nell'App. Gestire la pratica di riparazione non è mai stato così facile e veloce!

FR/ Qantum permet d'entrer rapidement les informations du véhicule. Le scanner intégré permet de numériser automatiquement le numéro de châssis (VIN) et la plaque d'immatriculation du véhicule. Les photos prises par le smartphone et la tablette sont immédiatement archivés dans l'application. Gérer la réparation n'a jamais été aussi simple et rapide!

ES/ Qantum permite introducir rápidamente la información del vehículo. La función de escáner integrada adquiere automáticamente el VIN (número de bastidor) y la matrícula del coche. La aplicación archiva inmediatamente las fotos tomadas desde un teléfono inteligente y tableta. Gestionar el expediente de reparación nunca ha sido tan fácil y rápido.

DE/ Mit Qantum können die Fahrzeuginformationen schnell eingegeben werden. Die eingebaute Scannerfunktion nimmt automatisch die Fahrzeug-Identifizierungsnummer (FIN) und das Autokennzeichen auf. Die mit dem Smartphone und Tablet aufgenommenen Bilder werden sofort als Anhang in der App archiviert. Einen Reparaturvorgang zu verwalten, war noch nie so einfach und schnell!

PT/ Qantum permite-lhe introduzir rapidamente informações sobre veículos. A função de scanner integrada captura automaticamente o VIN (Número de Chassis) e a matrícula do veículo. Fotos tiradas de smartphones e pastilhas tornam-se imediatamente anexos armazenados na aplicação. A gestão do ficheiro de reparação nunca foi tão rápida e fácil!



CONTROL

EN/ Once the spot-welding operations have been completed, the data can be viewed using graphs and analysed, the web App helps the person in charge of the body shop to assess the quality of the work being performed, wherever he may be!

IT/ Una volta finite le operazioni di puntatura, i dati possono essere visualizzati attraverso grafici e analizzati, aiutando il responsabile della carrozzeria a valutare la qualità del lavoro svolto ovunque si trovi, grazie l'applicazione web!

FR/ Les opérations de soudage par points terminées, les données peuvent être visualisées dans une forme graphique et avec des analyses, pour aider le responsable de la carrosserie à évaluer la qualité du travail réalisé où qu'il soit, grâce à l'application Web!

ES/ Una vez finalizadas las operaciones de soldadura por puntos, los datos pueden visualizarse con gráficos y analizarse, lo que ayuda al responsable de la carrocería a valorar la calidad del trabajo realizado esté donde esté, gracias a la aplicación web.

DE/ Nach Beendigung der Punktschweißarbeiten können die Daten über Grafiken angezeigt und analysiert werden. So erhält der Verantwortliche des Karosseriebetriebs egal, wo er ist, Unterstützung, die Qualität der geleisteten Arbeit durch die Webanwendung zu bewerten.

PT/ Uma vez terminadas as operações de soldadura por pontos, os dados podem ser visualizados através de gráficos e analisados, ajudando o gestor da oficina a avaliar a qualidade do trabalho realizado onde quer que esteja, graças à aplicação web!



COMPLETENESS

EN/ The App allows users to attach multiple photos before, during and after the work, to provide complete control over all operations and ease of reporting activities to be provided to the interested parties, such as customers and insurance companies.

IT/ L'applicazione permette di allegare molteplici foto prima, durante e dopo la lavorazione per avere il controllo completo sul lavoro svolto e per agevolare le attività di reportistica da fornire alle parti interessate come clienti e assicurazioni.

FR/ L'application permet de joindre plusieurs photographies avant, pendant et après le travail pour assurer un contrôle complet du travail réalisé et pour faciliter les activités de compte-rendu à faire aux parties concernées, comme les clients et les assureurs.

ES/ La aplicación permite adjuntar múltiples fotos antes, durante y después de la elaboración para tener un control completo del trabajo realizado y para facilitar las actividades de elaboración de los informes que se deben entregar a las partes interesadas, como clientes y como seguros.

DE/ Die Anwendung ermöglicht, viele Fotos vor, während und nach der Bearbeitung anzuhängen, um die geleistete Arbeit komplett kontrollieren zu können und um die Aktivitäten im Hinblick auf die Weitergabe der erstellten Berichte an die interessierten Parteien wie Kunden und Versicherungen zu unterstützen.

PT/ A aplicação permite anexar várias fotografias antes, durante e após o processamento para ter um controlo completo sobre o trabalho realizado e para facilitar a apresentação de relatórios aos interessados, tais como clientes e companhias de seguros.



COMPATIBILITY

EN/ The Telwin Inverspotter Wave spot welders, equipped with a WiFi* module, are compatible with Qantum. Spot welding data are sent to the Cloud platform, divided per vehicle and linked to the repair work formalities.

IT/ Le puntatrici Telwin Inverspotter Wave, corredate di modulo WiFi*, sono compatibili con Qantum. I dati di puntatura vengono inviati alla piattaforma Cloud dove sono organizzati per veicolo ed associati alla pratica di riparazione.

FR/ Les postes de soudage par points Telwin Inverspotter Wave, équipés du module WiFi*, sont compatibles avec Qantum. Les données du poste de soudage par points sont envoyées à la plateforme Cloud où elles sont organisées par véhicule et associées à l'atelier de réparation.

ES/ Las soldadoras por puntos Telwin Inverspotter Wave, con módulo WiFi*, son compatibles con Qantum. Los datos de soldadura por puntos se envían a la plataforma Cloud donde se organizan por vehículo y se asocian al expediente de reparación.

DE/ Die Inverspotter Wave Punktschweißmaschinen von Telwin mit WLAN-Modul* sind mit Qantum kompatibel. Die Punktschweißdaten werden an die Cloud-Plattform gesendet. Die Organisation verläuft dort nach Fahrzeug und sie werden dem Reparaturvorgang zugewiesen.

PT/ Os aparelhos de soldadura por pontos Telwin Inverspotter Wave, equipados com um módulo WiFi*, são compatíveis com Qantum. Os dados de soldadura por pontos são enviados para a plataforma Cloud, onde são organizados por veículo e associados ao ficheiro de reparação.

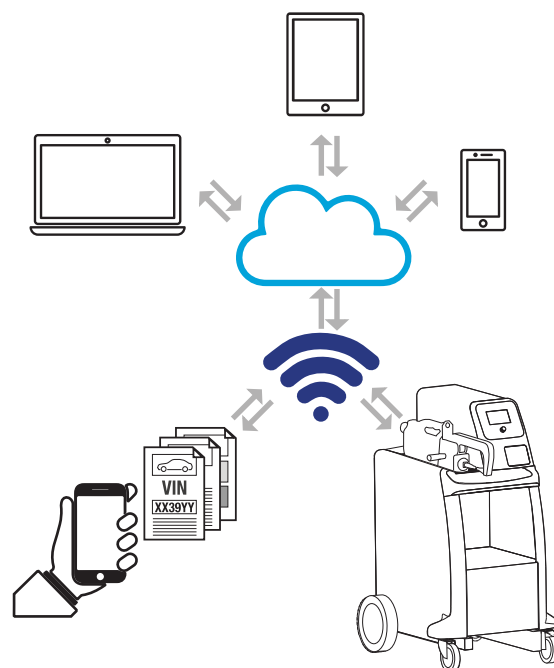

* could be optional - potrebbe essere opzionale - il peut être en option - puede ser opcional - es könnte optional sein - pode ser opcional

REPORTING

EN/ On completing the formalities, the dossier on the repair work can be produced, along with photos, documents attached during the repair work and graphic representations of the data collected during the spot-welding activity.

IT/ Chiusa la pratica, è possibile produrre il dossier della riparazione eseguita, corredato di foto, documenti allegati durante la lavorazione e rappresentazioni grafiche dei dati raccolti durante il funzionamento delle puntatrici.

FR/ La réparation terminée, le dossier réalisé peut être créé, avec des photographies, des documents liés à l'activité et les représentations graphiques des données collectées pendant l'opération du poste de soudage par points.

ES/ Una vez finalizado el expediente, se puede reproducir el dossier de la reparación realizada, acompañado de fotos, documentos adjuntados durante la elaboración y representaciones gráficas de los datos obtenidos durante el funcionamiento de las soldadoras por puntos.

DE/ Wenn der Vorgang abgeschlossen ist, kann eine Akte bzgl. der durchgeführten Reparatur mit Fotos, während der Bearbeitung anhängenden Unterlagen und grafischen Darstellungen der während des Betriebs der Punktschweißmaschinen gesammelten Daten angelegt werden.

PT/ Uma vez fechado o ficheiro, é possível produzir um ficheiro dos trabalhos de reparação realizados, completo com fotos, documentos anexados durante o processamento e representações gráficas dos dados recolhidos durante o funcionamento de aparelhos de soldadura por pontos.

DOWNLOAD

GET IT NOW!



App name:
Qantum



More info on:
qantumapp.com

INVERSPOTTER 13500 SMART AQUA



inverter

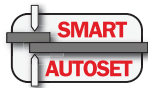

HSS READY



POWER GUN TECHNOLOGY



- EN/** • High currents and low consumptions (works on 16A fuse) (-)
 - Electromagnetic fields (EMF) certified safety
 - Wide range of operation (cable length 5 m)
 - Very handy in any jobs
- IT/** • Alte correnti con bassi consumi (linee con fusibile 16A) (-)
 - Sicurezza certificata per i campi elettromagnetici EMF
 - Elevato campo d'azione (cavi lunghezza 5 m)
 - Massima praticità di intervento
- FR/** • Hauts courants avec basses consommations (lignes avec fusibles 16A) (-)
 - Sécurité pour les champs électromagnétiques EMF
 - Champ élevé d'action, (longueur câbles 5M)
 - Meilleure praticité d'intervention
- ES/** • Altas corrientes con bajos consumos (líneas con fusible 16A) (-)
 - Seguridad certificada para los campos electromagnéticos EMF
 - Elevado campo de acción (longitud del cable 5m)
 - Máxima funcionalidad de intervención
- DE/** • Hohe Stromwerte bei niedrigem Verbrauch (Netze mit 16A Sicherung) (-)
 - Bescheinigte Sicherheit im Rahmen der EMF elektromagnetischen Felder
 - Weiter Betriebsbereich (5 mt lange Kabel)
 - Größte Einsatzzweckmäßigkeit
- PT/** • Correntes altas com baixos consumos (linhas com fusíveis 16A) (-)
 - Segurança certificada dos campos eletromagnéticos (EMF)
 - Amplo campo de aplicações (cabo 5 m)
 - Muito prático para qualquer trabalho



INCLUDED

CAPS EXTRACTOR
712331



App name: **Qantum**
compatible (-)

OPTIONAL

CONNECTED PACK
804912
SMART PACK
804913
EXPERT PACK
804914

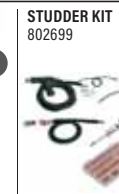

→ CONSUMABLES Pag. 57

Pag. 56

TECHNICAL DATA

CE EAC	CODE	V _{3PH} V (50-60Hz)	A _{OUT} A	V ₀ V	P _{MAX} kW	P _{50%} kW	φ	f _L Hz	mm	daN	DUTY CYCLE %	IP	LxWxH cm	kg
● INVERSPOTTER 13500 SMART AQUA	823349	400 3ph	12000	9	41	8	0,95	5000	3 + 3 + 3	400	2	IP20	79 x 45 x 90	81

AQUA = Water cooled • Raffreddata ad acqua • Refroidie à l'eau • Refrigerada por agua • Wassergekühlte • Refrigeração a água

(-) with Wi-fi connectivity kit • con kit connettività Wi-fi • avec kit de connectivité Wi-fi • con kit de conectividad Wi-fi • mit Wi-fi-Verbindungs-Kit • com kit de ligação Wi-fi

INVERSPOTTER 13500 SMART AQUA



EN/ Medium frequency, direct current (MFDC) inverter technology, microprocessor controlled resistance (spot) welding machines. In comparison with traditional spot welders, the POWER GUN technology (power circuits integrated in the clamp) allows for high spot-welding currents with low absorption rates, the use of longer (5 m) and lighter cables for a better holding and a wider range of action and minimum magnetic fields around the cables. Particularly suitable for body shop applications and repair-shops and give excellent results also on high strength steel (HSS) and galvanised metal sheets. The innovative SMART AUTOSET technology, thanks to the automatic recognition of the materials and thickness, eliminates set-up times and guarantees optimal spot welding even if the types of steel to be processed are not known. WAVE technology facilitates interaction with the machine and tracks all operating parameters for their processing and reporting. The programmes and reports generated can be transferred to a USB flash drive for printing or viewing on a PC. Features: SMART AUTOSET technology - 128 standard programmes and more than 400 customizable ones - automatic recognition of the arm and inserted tool - preand post-heating for interventions on HSS and galvanized metals - automatic cooling control of machine, clamp and cables - regulation of approach, slope and welding times - regulation in pulsed welding (pulse number and intervals) - automatic/manual regulation of pressure between electrodes. Complete with water-cooled, pneumatic gun.

IT/ Saldatrici a resistenza (puntatrici) a tecnologia inverter in corrente continua a media frequenza (MFDC), controllate a microprocessore. La tecnologia POWER GUN (circuiti di potenza integrati in pinza) consente, rispetto alle puntatrici tradizionali, elevate correnti di puntatura con ridotti assorbimenti di rete, l'utilizzo di cavi molto più lunghi (5 m) e leggeri per una migliore maneggevolezza ed un più ampio campo di azione, minimi campi magnetici presenti nell'intorno dei cavi. Particolarmente adatte all'utilizzo in carrozzeria ed in officina, assicurano ottimi risultati anche su acciai ad alta resistenza (HSS) e su lamiere zincate. L'innovativa tecnologia SMART AUTOSET, grazie al riconoscimento automatico dei materiali e dello spessore, elimina i tempi di set-up e garantisce puntature ottimali pur non conoscendo le tipologie di acciai su cui si opera. La tecnologia WAVE facilita l'interazione con la macchina e traccia tutti i parametri di lavorazione per una loro elaborazione e reportistica. I programmi e i report generati possono essere trasferiti su chiavetta USB per la stampa o visualizzazione da PC. Caratteristiche: tecnologia SMART AUTOSET - 128 programmi standard ed oltre 400 personalizzabili - riconoscimento automatico del braccio e dell'utensile inserito - preriscaldamento e post-riscaldamento per interventi su metalli HSS e zincati - controllo automatico raffreddamento macchina, pinza e cavi - regolazione tempi di accostaggio, di rampa, di saldatura - regolazioni in pulsato (numero e intervallo tra impulsi) - regolazione automatica/manuale della pressione tra gli elettrodi. Complete di pinza pneumatica raffreddata ad acqua.

FR/ Postes de soudage par points a technologie inverseur en courant continu a fréquence moyenne (MFDC), contrôlés par microprocesseur. La technologie POWER GUN (circuits de puissance intégrée dans la pince), permet, par rapport aux les postes de soudage par points traditionnel, un courant de pointage élevé avec absorptions réduites de réseau, la jouissance de câbles plus long (5m) et léger avec un meilleure maniabilité et un plus grand champ d'action, une diminution non négligeable de champs magnétiques autour des câbles. Particulièrement prévus pour les applications en carrosserie et en milieu industriel, ils garantissent résultats excellents aussi sur aciers a haute limite d'élasticité (HLE) et les tôles zinguées. La technologie innovatrice SMART AUTOSET, grâce a la reconnaissance automatique des matériaux et de l'épaisseur, élimine les temps de réglage et garantit des soudages par points optimaux même si on ne connaît pas les typologies d'acier sur lesquelles on opère. La technologie WAVE simplifie l'interaction avec la machine et trace tous les paramètres de travail pour leur élaboration et traçage. Les programmes et les rapports gènes peuvent être transférés sur clé USB pour l'impression ou l'affichage en provenance de PC. Caractéristiques: technologie SMART AUTOSET - 128 programmes standards et plus de 400 personnalisables - reconnaissance automatique outil inséré et bras - pré-réchauffement et post-réchauffement pour des interventions sur des métaux et galvanisés - contrôle automatique refroidissement machine, et câbles - réglage temps d'accostage, de rampe, de soudage - réglages en (nombre et intervalles entre impulsions) - réglage automatique/manuel de la pression entre les électrodes. Fournis de série avec pince pneumatique refroidie à eau.



APPROVED
by



COMPLETE WITH OPTIONAL:
POLE AND BALANCER,
360 RING KIT
(823349+802650+802866)



MMA WELDING

MIG-MAG WELDING

TIG WELDING

PLASMA CUTTING

SPOT WELDING

CHARGING & STARTING

INDEX

INVERSPOTTER 14000 SMART AQUA



inverter

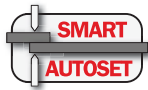

**HSS
READY**



**READY FOR ANY
TYPE OF STEEL**



EN/ Forget about type of material, manual settings and reference tables!
The Made-in-Telwin technology, Smart Autoset allows the automatic detection of both material and thickness, all you need to do is weld!

IT/ Dimentica il tipo di materiale, le regolazioni manuali, le tabelle di riferimento!
La tecnologia Smart Autoset Made in Telwin rileva automaticamente il tipo e lo spessore dei materiali da saldare.

FR/ Oubliez le type de matériel, les réglages manuels, les tableaux de référence!
La technologie Smart Autoset Made in Telwin détecte automatiquement le type et l'épaisseur des matériaux à souder.

ES/ Olvida el tipo de material, las regulaciones manuales, las tablas de referencia!
La tecnología Smart Autoset Made in Telwin detecta automáticamente el tipo y el espesor de los materiales a soldar.

DE/ Vergessen Sie die Werkstoffart, die manuellen Einstellungen, die Richttabellen!
Die Technologie Smart Autoset - Made in Telwin - erkennt automatisch die Art und Stärke der Schweißwerkstoffe.

PT/ Esqueça o tipo de material, as regulações manuais e tabelas de referência!
A tecnologia Smart Autoset Made in Telwin permite detetar automaticamente o material e a sua espessura. Só tem que soldar!



INCLUDED

CAPS EXTRACTOR
712331



App name: **Quantum**
compatible (-)



OPTIONAL

→ CONSUMABLES Pag. 57

CONNECTED PACK 804912	LOAD BALANCER AND SUPPORT KIT 802650	X POWER GUN 5m 801063	360 RING KIT 802866	COOLANT FOR COOLING SYSTEMS 5L 802976 (x2)	CAPS MAINTENANCE KIT AQUA CMKA 802767	MACHINE ANTIDUST COVER 804073	WALL ARMS ORGANISER KIT 803106	STUDDER KIT 802699	WI-FI CONNECTIVITY KIT 803069
SMART PACK 804913									
EXPERT PACK 804914									
SHARK EXPERT PACK 804915									

TECHNICAL DATA

CE EAC	CODE	V_{3PH} V (50-60Hz)	A_{OUT} A	V₀ V	P_{MAX} kW	P_{50%} kW	Ø mm	JFL Hz	mm	daN	DUTY CYCLE %	IP	LxWxD cm	kg
● INVERSPOTTER 14000 SMART AQUA	823350	400 3ph	15000	13	68	10	0,8	8000	3 + 3 + 3	580	2	IP20	80 x 52 x 115	100

INVERSPOTTER 14000 SMART AQUA - 823353 - V_{3PH} 200-240 3ph 157 kg

(-) with Wi-fi connectivity kit - con kit connettività Wi-fi - avec kit de connectivité Wi-fi - con kit de conectividad Wi-fi - mit Wi-fi-Verbindungsset - com kit de ligação Wi-fi

INVERSPOTTER 14000 SMART AQUA



ES/ Soldadoras de resistencia (soldadora por puntos) con tecnología inverter en corriente continua a media frecuencia (MFDC), controladas por microprocesador. La tecnología POWER GUN, (circuitos de potencia integrados en pinza), permite, con respecto de los soldadoras por puntos tradicionales, elevadas corrientes de soldadura con reducidas absorciones de red, el empleo de cables mucho más largo (5m) y ligero por una mejor manejabilidad y un mas amplio campo de acción, mínimo campo magnético presente alrededor de los cables. Particularmente adecuadas para aplicaciones en carrocería y en taller de reparaciones, aseguran óptimos resultados también en aceros con alto límite de deformación (HSS) y chapas zincadas. La tecnología innovadora SMART AUTOSET, gracias al reconocimiento automático de los materiales y del espesor, elimina los tiempos de configuración y garantiza soldaduras por puntos óptimas, aunque no se conozcan los tipos de acero en que se está operando. La tecnología WAVE facilita la interacción con la máquina y rastrea todos los parámetros operativos para su procesamiento y presentación de informes. Los programas y los informes generados pueden transferirse en una llave USB para la impresión o la visualización mediante PC. Características: tecnología SMART AUTOSET · 128 programas de soldadura por puntos estándar y además 400 personalizables · reconocimiento automático del brazo y de la herramienta introducida · precalentamiento y postcalentamiento para intervenciones en metales HSS y cincados · control automático del enfriamiento de la máquina, pinza y cables · regulación de los tiempos de compresión, de rampa, de soldadura · regulaciones en pulsado (número e intervalo entre impulsos) · regulación automática/manual de la presión entre los electrodos. Equipadas con pinza neumática refrigerada por agua.

DE/ Mikroprozessorgesteuerte, Inverter-widerstandsschweißgeräte (Punktschweißgeräte) mit mittelfrequenter Gleichstrombetrieb (MFDC). Die POWER-GUN-Technologie (in der Zange integrierte Leistungsschaltungen) erlaubt es, im Vergleich zu den traditionellen Punktschweißgeräten, hohe Punktschweißstromwerte bei verringerten Netzaufnahmen zu gewinnen, viel längere (5m) und leichtere Kabel zu verwenden, die eine bessere Handlichkeit und einen weiteren Anwendungsbereich gewähren, und geringste magnetische Felder um die Kabeln herum zu haben. Insbesondere geeignet für den Einsatz in Karosseriewerkstätten und Reparaturwerkstätten, gewährleistet fachgerechte Resultate auch auf Stähle mit hoher Streckgrenze (HSS) und verzinkten Blechen. Die innovative Technologie SMART AUTOSET vermeidet dank der automatischen Erkennung der Werkstoffe und der Werkstoffstärke Einrichtungszeiten und garantiert optimale Punktschweißergebnisse auch dann, wenn die Art der geschweißten Stähle nicht bekannt ist. Die WAVE Technologie erleichtert die Interaktion mit der Maschine und verfolgt alle Betriebsparameter für ihre Verarbeitung und Berichterstattung. Die generierten Programme und Berichte können anschließend zwecks Ausdruck oder Anzeige am PC auf einen USB Speicherstick überspielt werden, außerdem, die automatische Druckkontrolle gestattet die optimale Einstellung der auf die Zangenelektroden einwirkenden Kraft. Eigenschaften: Technologie SMART AUTOSET · 128 Standard- und mehr als 400 personalisierbare Punktschweißprogramme · automatische Erkennung des Schweißarms und des eingesetzten Werkzeugs · Vorwärmen und Nachwärmen bei Arbeiten auf HSS Metallen und verzinkten Metallen · automatische Kühlsteuerung von Maschine, Zange und Kabeln · Zeitvorgaben Annäherung, Rampendauer, Schweißsdauer · Einstellungen im Impulsbetrieb (Anzahl und Zeitspanne zwischen den Impulsen) · Automatische/manuelle Einstellung des Drucks zwischen den Elektroden. Komplet mit Wassergekühlter Zange.

PT/ Aparelhos de soldar por pontos de frequência média, em corrente contínua (MFDC) com tecnologia inverter e com controlo por microprocessador. Em comparação com os aparelhos tradicionais de soldadura por pontos, a tecnologia POWER GUN (circuitos integrados na pinça) permite correntes elevadas de soldadura por pontos com baixa taxa de absorção, a utilização de um cabo mais longo (5 m) e mais leve para melhor manuseamento e um maior número de aplicações, com campos magnéticos mínimos ao redor dos cabos. Particularmente adequado para aplicações em oficinas bate-chapas e de reparação de carroçarias, proporcionando também excelentes resultados em aço de alta resistência (HSS) e em chapas metálicas galvanizadas. A inovadora tecnologia smart autose, graças ao reconhecimento automático de materiais e espessura, elimina tempos de regulação e garante uma ótima soldadura por pontos mesmo quando se desconhecem os tipos de aço a processar. A tecnologia WAVE facilita a interação com a máquina e memoriza todos os parâmetros de trabalho para seu processamento e registo. Os programas e relatórios gerados podem ser transferidos para um dispositivo USB, para impressão ou consulta em PC. Características: tecnologia SMART AUTOSET · 128 programas standard e mais de 400 personalizáveis · reconhecimento automático do braço e da ferramenta · pré- e pós-aquecimento para intervenções em metais HSS e galvanizados · controlo automático da refrigeração da máquina, pinça e cabos · regulação da aproximação, curva e tempos de soldadura · regulação em soldadura pulsada (número de impulsos e intervalos) · regulação automática/manual da pressão entre elétrodos. Completo com pistola pneumática com refrigeração a água.

APPROVED
by



Mercedes Benz

GM General Motors



GMC



FIAT

IVECO

BMW



MMA WELDING

MIG-MAG WELDING

TIG WELDING

PLASMA CUTTING

SPOT WELDING

CHARGING & STARTING

INDEX



**COMPLETE WITH OPTIONAL:
POLE AND BALANCER, 360 RING KIT**
(823350+802650+802866)

INVERSPOTTER PACK



		INVERSPOTTER CONNECTED PACK 804912	INVERSPOTTER SMART PACK 804913	INVERSPOTTER EXPERT PACK 804914	INVERSPOTTER SHARK EXPERT PACK 804915
for INVERSPOTTER 13500 SMART AQUA		■	■	■	
for INVERSPOTTER 14000 SMART AQUA		■	■	■	■
LOAD BALANCER AND SUPPORT KIT 802650		■	■	■	■
360 RING KIT 802866		■	■	■	■
CA3 ARM L=300MM + ELECTRODE 803171			■	■	■
CA4 ARM L=550MM + ELECTRODE 803172		■	■	■	
CA5 ARM L=42MM + ELECTRODE 803181		■	■	■	■
CA6 ARM L=430MM + ELECTRODE 803187				■	
CA7 SHARK ARM L=635MM 803189					■
ELECTRODE HOLDER KIT long/short 802868				■	■
CMKA CAPS A MAINTENANCE KIT 802767		■	■	■	■
WI-FI CONNECTIVITY KIT X INVERSPOTTER 803069		■	■	■	■
MACHINE ANTIDUST COVER 804073			■	■	■
WALL ARMS ORGANISER KIT 803106				■	■
COOLANT FOR COOLING SYSTEMS 5L (x2) 802976		■	■	■	■

INVERSPOTTER 13500 SMART AQUA - 14000 SMART AQUA



WI-FI CONNECTIVITY KIT: GET YOUR INVERSPOTTER CONNECTED!

803069



INVERSPOTTER 13500 SMART AQUA - 14000 SMART AQUA

WATER COOLED ARMS

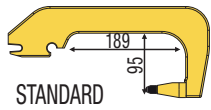

STANDARD

CA1

ARM + ELECTRODE
L=95 mm - 803169

ELECTRODE HOLDER KIT long/short

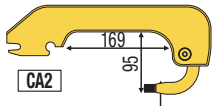
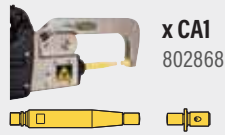

CA2

ARM + ELECTRODE
L=95 mm - 803170

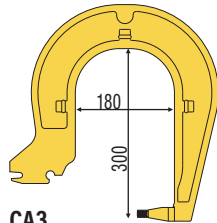

CA3

ARM + ELECTRODE
L=300 mm - 803171

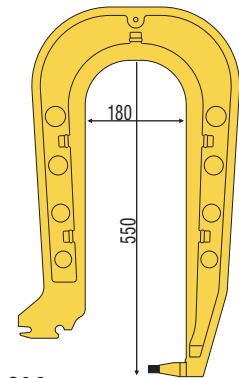

CA4

ARM + ELECTRODE
L=550 mm - 803172

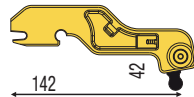

CA5

ARM + ELECTRODE
L=42 mm - 803181

KIT CURVED ELECTRODE CA5 804241

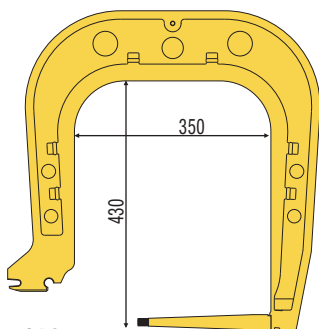
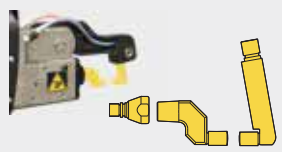

CA6

ARM + ELECTRODE
L=430 mm - 803187

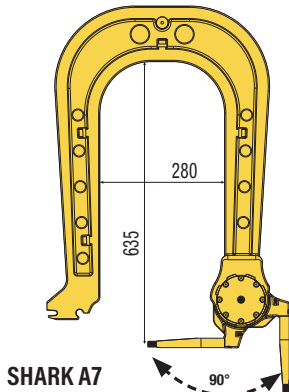

SHARK A7

ARM + ELECTRODE
L=635 mm - 803189

ELECTRODES



PRODUCTS	INVERSPOTTER 13500 SMART AQUA	INVERSPOTTER 14000 SMART AQUA
CA1	b	a
CA2		a
CA3		a
CA4		a
CA5		c
CA6		a
SHARK A7		a
CMKB	▪	
CMKA	▪	▪

MAINTENANCE KIT



ARM WALL ORGANIZER KIT

2 PCS 600X600 mm
803106

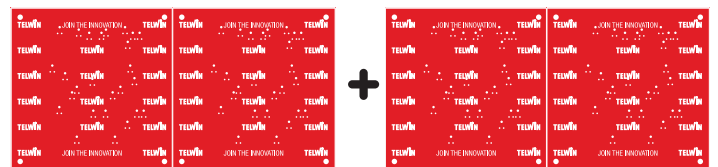

MMA WELDING

MIG-MAG WELDING

TIG WELDING

PLASMA CUTTING

SPOT WELDING

CHARGING & STARTING

INDEX

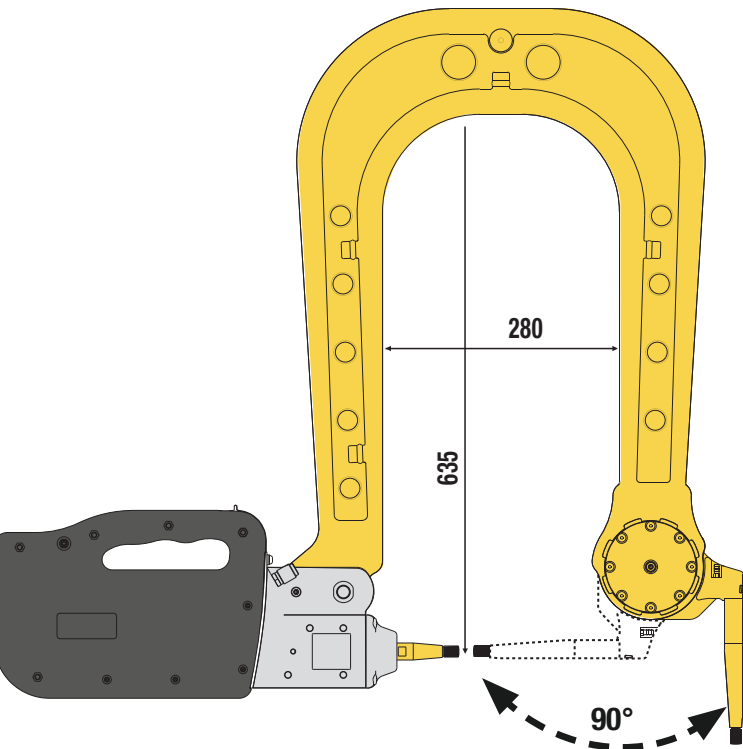

SHARK

803189



APPROVED
by

Mercedes Benz



WATCH
THE VIDEO

ELECTRODES



L= 18 mm - 690130



OPENING · APERTURA · OUVERTURE
APERTURA · ÖFFNUNG · ABERTURA



INSERTING · INSERIMENTO · INSERTION
· INSERCIÓN · EINFÜGEN · INSERINDO



SPOT WELDING · PUNTATURA · POINTAGE
· SOLDADURA POR PUNTOS · PUNKTSCHWEISSEN
· SOLDADURA POR PONTOS

EN/ Shark A7 is a revolutionary arm designed to speed up and simplify spot welding operations in the most difficult to access areas. Thanks to the patented "large opening" mechanism, the end section of the Shark A7 opens 90° by simply pressing with your finger, even allowing insertion in boxed or difficult to reach parts. Once closed, it is ready to spot weld. Shark A7 allows access to welding positions on rear or platform coatings, impossible to reach with traditional systems.

IT/ Shark A7 è il rivoluzionario braccio ideato per velocizzare e semplificare le operazioni di puntatura nelle zone di più difficile accesso. Grazie al meccanismo brevettato di "grande apertura", la sezione terminale di Shark A7 si apre di 90° con una semplice pressione del dito, permettendone l'inserimento anche in parti scatolate o difficilmente raggiungibili. Una volta chiuso è già pronto per puntare. Shark A7 consente di accedere a posizioni di saldatura su rivestimenti posteriori o pianali, impossibili da raggiungere con i sistemi tradizionali.

FR/ Shark A7 est le bras révolutionnaire pensé pour accélérer et simplifier les opérations de soudage par points dans les zones les plus difficiles d'accès. Grâce au mécanisme breveté de « grande ouverture », la section terminale de Shark A7 s'ouvre de 90° par une simple pression du doigt, ce qui en permet l'insertion même dans des parties encastrées ou difficiles à atteindre. Une fois refermé, il est déjà prêt à souder par points. Shark A7 permet d'accéder à des positions de soudage sur des revêtements postérieurs ou des plateaux, impossibles à atteindre avec les systèmes traditionnels.

ES/ Shark A7 es el revolucionario brazo ideado para hacer más rápidas y sencillas las operaciones de soldadura por puntos en las zonas con un acceso más difícil. Gracias al mecanismo patentado de "gran apertura", la sección terminal de Shark A7 se abre 90° con una simple presión del dedo, y puede introducirse también en partes tapadas o difíciles de alcanzar. Una vez cerrado, ya está preparado para soldar por puntos. Shark A7 permite acceder a posiciones de soldadura en revestimientos posteriores o plataformas, imposibles de alcanzar con sistemas tradicionales.

DE/ Der bahnbrechende Arm Shark A7 wurde entwickelt, um die Punktschweißarbeiten von schwer zugänglichen Bereichen schneller durchführen zu können und diese zu erleichtern. Durch den patentierten Mechanismus „große Öffnung“ öffnet sich der letzte Abschnitt von Shark A7 um 90° durch ein einfaches Andrücken des Fingers, sodass sogar ein Einführen in kastenförmige oder schwer zugängliche Bereiche ermöglicht wird. Einmal wieder verschlossen, ist er schon zum Punkten bereit. Mit Shark A7 können Schweißlagen bei hinteren Verkleidungen oder Plattformen eingenommen werden, die mit traditionellen Systemen nicht erreicht werden können.

PT/ Shark A7 é o revolucionário braço concebido para tornar mais rápidas e simples as operações de soldadura por pontos nas zonas de mais difícil acesso. Graças ao mecanismo patenteado de "grande abertura", a secção terminal de Shark A7 abre-se a 90° com a simples pressão de um dedo, permitindo a sua introdução mesmo em partes encaixotadas ou dificilmente alcançáveis. Depois de fechado, está pronto para realizar a soldadura por pontos. Shark A7 permite aceder a posições de soldadura em revestimentos posteriores ou plataformas, impossíveis de alcançar com sistemas tradicionais.

MODULAR 20 TI - DIGITAL MODULAR 230 - 400



mod. 20/TI, 230 mod. 400



STANDARD

STRAIGHT ARM PAIR
XA1
803151

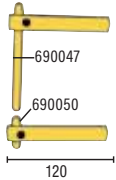

OPTIONAL

ARMS & ELECTRODES



Pag.90

DIGITAL MODULAR 230

823016



TECHNICAL DATA

CE EAC	CODE	V _{PH} V (50-60Hz)	A _{OUT} A	V ₀ V	P _{50%} kW	A _{max} A	Ø mm	mm	DUTY CYCLE %	IP	LxWxH cm	kg
MODULAR 20/TI	823015	230 1ph	5800	2	1,4	16	0,9	1 + 1	1,5	IP20	44 x 10 x 18,5	9,9
DIGITAL MODULAR 230	823016	230 1ph	6900	2,5	1,4	25	0,9	2 + 2	1,5	IP20	44 x 10 x 18,5	10,5
DIGITAL MODULAR 400	823017	400 2ph	6900	2,5	1,6	16	0,9	2 + 2	1,5	IP20	44 x 10 x 18,5	10,3

EN/ Spot welding machines with electronic control of the spot welding time. Features: synchronous electronic timer with spot welding time adjustable from 0,1 sec. to 1,2 sec. (mod. 20/TI) - "FUZZY LOGIC" microprocessor control and choice between continuous and pulsed operation (suitable for sheets with high yield points - high stress) (mod. DIGITAL) - arms pressure adjustable from 40 kg to 120 kg (standard arms: 120 mm).

IT/ Saldatrici a resistenza (puntatrici) con controllo elettronico del tempo di puntatura. Caratteristiche: timer elettronico sincrono, con tempo di puntatura regolabile da 0,1 sec. a 1,2 sec. (mod. 20/TI) - controllo a microprocessore "FUZZY LOGIC" e funzionamento in continuo e pulsato (adatto per lamiere ad alto coefficiente di snervamento high-stress) (mod. DIGITAL) - forza sui bracci regolabile da 40 kg a 120 kg (bracci standard: 120 mm).

FR/ Postes de soudage par points, avec contrôle électronique du temps de pointage. Caractéristiques: temporisateur électronique synchrone avec temps de pointage réglable de 0,1 à 1,2 sec. (mod. 20/TI) - système de contrôle par microprocesseur "FUZZY LOGIC" et fonctionnement en continu et par pulsations (pour les tôles à coefficient d'élasticité élevé-high stress) (mod. DIGITAL) - force réglable sur les bras de 40 kg à 120 kg (bras standard: 120 mm).

ES/ Soldadoras por puntos, con control electrónico del tiempo de soldadura por puntos. Características: temporizador electrónico sincrónico, con tiempo de soldadura por puntos regulable de 0,1 seg. a 1,2 seg. (mod. 20/TI) - sistema de control por microprocesador "FUZZY LOGIC" y funcionamiento en continuo y pulsado (apto para chapas con alto coeficiente de deformación, high-stress) (mod. DIGITAL) - fuerza en los brazos regulable de 40 kg a 120 kg (brazos estándar: 120 mm).

DE/ Punktschweißgeräte mit elektronischer Steuerung der Punktschweißdauer. Eigenschaften: Elektronischer Synchrontimer, mit einstellbarer Punktschweißdauer von 0,1 bis 1,2 Sek. (mod. 20/TI) - Steuerungssystem "FUZZY LOGIC" und Auswahl zwischen Schweißbetrieb mit Dauerund Impulsstrom (geeignet für Bleche mit hohem Streckkoeffizienten- high stress) (mod. DIGITAL) - Kraft der Arme einstellbar von 40 kg bis 120 kg (Standard Armen: 120 mm).

PT/ Aparelhos de soldadura por pontos com contro electrónico do tempo de soldadura. Características: temporizador electrónico sincronizado com regulação do tempo de soldadura por pontos de 0,1 seg. a 1,2 seg. (mod. 20/TI) - controlo por microprocessador "FUZZY LOGIC" e escolha entre trabalho contínuo ou pulsado (adequado para chapas com elevado coeficiente de deformação, tensão) (mod. DIGITAL) - pressão dos braços ajustável de 40 kg a 120 kg (braços standard: 120 mm).

MMA WELDING

MIG-MAG WELDING

TIG WELDING

PLASMA CUTTING

SPOT WELDING

CHARGING & STARTING

INDEX

BATTERY CHARGER & STARTER CHOICE TABLE

		CHARGE 15h		MAINTENANCE			START		5 min. pre charge + START				AUTOMATIC							
		20 Ah	60 Ah	80 Ah	100 Ah	150 Ah	200 Ah	> 250 Ah	WET	GEL AGM MF	EFB START STOP	Li	TEST	TRONIC	PULSE TRONIC					
Charge	DEFENDER 8								•	•	•			✓						
	DEFENDER 12								•	•	•			✓						
	DEFENDER 20								•	•	•			✓						
	AUTOTRONIC 25 BOOST								•	•	•			✓						
	T-CHARGE 12 - 12 EVO								•	•	•	• EVO	✓ EVO		✓					
	T-CHARGE 20 - T-CHARGE 20 EVO - 26 EVO								•	•	•			✓						
	PULSE 30 EVO, PULSE 50 EVO, DOCTOR CHARGE 55 CONNECT, 50, DOCTOR CHARGE 130								•	•	•	• EVO	✓ EVO		✓					
	TOURING								•	•	•			✓						
	NEVADA								•											
	ALPINE 15								•											
	ALPINE 18 - 20 BOOST								•											
	ALPINE 30 - 50 BOOST								•											
	NEVABOOST 100								•											
COMPUTER 48/2 PROF								•												
Charge & Start	DOCTOR CHARGE 130								•	•	•	•	✓		✓					
	ALASKA 150 - 200 START								•	•	•			✓						
	LEADER 150 START								•											
	LEADER 220 START								•											
	DOCTOR START 330								•	•	•	•	✓		✓					
	LEADER 400 START - SPRINTER 3000 START - DYNAMIC 320 START								•											
	DOCTOR START 530 - 630								•	•	•	•	✓		✓					
	SPRINTER 4000 - 6000 START - DYNAMIC 420 - 520 - 620 START								•											
	ENERGY 650 - 1000 START								•											
	ENERGY 1500 START								•											
Start	12V		20 Ah	60 Ah	80 Ah	100 Ah	150 Ah	200 Ah	24V							80 Ah	120 Ah	150 Ah	220 Ah	
	DRIVE MINI																			
	DRIVE 9000 - 1500 - 1750 XC																			
	DRIVE PRO 12																			
	STARTZILLA 4012 XT																			
	STARTZILLA 9012 XT																			
	PRO START 2824 - DRIVE PRO 12/24																			
	STARTZILLA 9024 XT																			
	START PLUS 4824																			
START PLUS 6824 - STARTZILLA 12024 XT																				

TYPES OF BATTERIES

EN/ WET Batteries: Lead-Antimony (PbSn) or Lead-Calcium (PbCa) or Lead Calcium-Silver (PbCaAg) batteries with liquid electrolyte.

IT/ Batterie WET: Batterie al Piombo-Antimonio (PbSn) o Piombo-Calcio (PbCa) o Piombo-Calcio Argento (PbCaAg) con elettrolita liquido.

FR/ Batteries WET: Batteries au plomb-antimoine (PbSn) ou plomb-calcium (PbCa) ou plomb-calcium-argent (PbCaAg) avec électrolyte liquide.

EN/ GEL Batteries: Lead-Calcium batteries (PbCa) with solid gelatinous electrolyte. Given that these batteries are completely sealed. Maintenance free.

IT/ Batterie GEL: batterie al Piombo-Calcio (PbCa) ad elettrolita solido di tipo gelatinoso completamente sigillate. Sono batterie senza manutenzione.

FR/ Batteries GEL: Batteries au Plomb-Calcium (PbCa) à électrolyte solide de type gélatineux, complètement hermétiques. Ces batteries demandent pas d'entretien.

EN/ AGM (ABSORBENT GLASS MAT) batteries: lead batteries with electrolyte absorbed in fibreglass. Completely sealed. They are maintenance-free batteries.

IT/ Batterie AGM (ABSORBENT GLASS MAT): batterie al Piombo ad elettrolita assorbito in fibra di vetro. Completamente sigillate. Sono batterie senza manutenzione.

FR/ Batteries AGM (ABSORBENT GLASS MAT): batteries au plomb à électrolyte absorbé en fibre de verre. Totalemant étanche. Ce sont des batteries qui ne nécessitent pas d'entretien.

EN/ AGM+ batteries: they ensure a higher number of start-ups at higher current and more in-depth discharge than standard AGM. Used on vehicles with Start-Stop system. Compact dimensions, greater resistance to vibrations and fast recharge times.

IT/ Batterie AGM+: assicurano un numero maggiore di avviamenti ad una corrente superiore ed una più elevata profondità di scarica delle AGM standard. Usate nei veicoli dotati di sistema Start-Stop. Dimensioni ridotte, maggiore resistenza alle vibrazioni e tempi di ricarica veloci.

FR/ Batteries AGM+: elles garantissent un nombre supérieur de démarrages à un courant plus fort et une plus grande profondeur de décharge que les AGM standard. Utilisées sur les véhicules avec système Start-Stop. Dimensions réduites, plus haute résistance aux vibrations et temps de recharge rapide.

EN/ EFB (Enhanced Flooded Battery) batteries: liquid electrolyte batteries with a higher recharge capacity and which support a higher quantity of cycles (start-ups) than traditional ones. Ideal for vehicles with Start-Stop system.

IT/ Batterie EFB (Enhanced Flooded Battery): batterie ad elettrolita liquido con una migliore capacità di ricarica e che supportano una quantità di cicli (avviamenti) superiore rispetto a quelle tradizionali. Ideali per veicoli dotati di sistema Start-Stop.

FR/ Batteries EFB (Enhanced Flooded Battery): batteries à électrolyte liquide à meilleure capacité de recharge et supportant davantage de cycles (démarrages) que les traditionnelles. Idéales pour véhicules avec système Start-Stop.

EN/ Lithium batteries: batteries with reduced weight, high energy density and very low auto-discharge. They are mainly used in the world of motorsport.

IT/ Batterie al Litio: batterie con peso ridotto, alta densità energetica e bassissima autoscarica. Sono utilizzate principalmente nel mondo del motorsport.

FR/ Batteries au lithium: batteries plus légères, à haute densité énergétique et très basse auto-décharge. Elles sont principalement utilisées dans le sport automobile.

ES/ Baterías WET: Baterías al plomo-antimonio (PbSn) o plomo-calcio (PbCa) o plomo-calcio-plata (PbCaAg) con electrólito líquido.

DE/ WET Batterien: Blei-Antimon-Batterien (PbSn) oder Blei-Kalzium-Batterien (PbCa) oder Blei-Kalzium-Silber-Batterien (PbCaAg) mit flüssigem Elektrolyt.

PT/ Baterias WET: baterias Chumbo-Antimónio (PbSn) ou Chumbo-Cálcio (PbCa) ou Chumbo Cálcio-Prata (PbCaAg) com eletrólito líquido.

ES/ Baterías GEL: baterías al Plomo-Calcio (PbCa) de electrólito sólido detipo gelatinoso completamente cerradas. No necesitan mantenimiento.

DE/ GEL-Batterien: Komplett versiegelte Bleikalzium-Batterien (PbCa) mit festem, gelartigem Elektrolyt. Wartungsfreie Batterien.

PT/ Baterias GEL: baterias Chumbo-Cálcio (PbCa) com eletrólito sólido gelatinoso, totalmente seladas. Não necessitam manutenção.

ES/ Baterías AGM (ABSORBENT GLASS MAT): baterías al plomo de electrolito absorbido en fibra de vidrio. Completamente selladas. Son baterías sin mantenimiento.

DE/ AGM (ABSORBENT GLASS MAT) Batterien: Bleibatterien mit in Glasfaser gebundenem Elektrolyt. Vollständig verschlossen. Die Batterien sind wartungsfrei.

PT/ Baterias AGM (ABSORBENT GLASS MAT): baterias Chumbo-Cálcio com eletrólito sólido (PbCa) . Totalmente seladas. Não necessitam manutenção.

ES/ Baterías AGM+: aseguran un número superior de arranques con una corriente superior y una profundidad de descarga más elevada que las AGM estándar. Se usan en los vehículos dotados de sistema Start-Stop. Dimensiones reducidas, mayor resistencia a las vibraciones y tiempos de recarga rápidos.

DE/ AGM+ Batterien: eine höhere Anzahl an Startvorgängen bei höherem Stromwert und einer höheren Entladungstiefe als bei den AGM-Standardbatterien. Sie werden in Fahrzeugen mit Start-Stopp-System verwendet. Kompakt sowie widerstandsfähiger gegenüber Vibrationen und schnelle Ladezeiten.

PT/ AGM+ baterias: asseguram mais arranques com uma corrente mais elevada e uma maior profundidade de descarga do que as AGMs normais. Utilizadas em veículos equipados com o sistema Start-Stop. Dimensões reduzidas, maior resistência à vibração e tempos de carga rápidos.

ES/ Baterías EFB (Enhanced Flooded Battery): baterías de electrolito líquido con una mejor capacidad de recarga y que admiten una cantidad de ciclos (arranques) superior respecto a las tradicionales. Ideales para los vehículos dotados de sistema Start-Stop.

DE/ EFB (Enhanced Flooded Battery) Batterien: Batterien mit Flüssigelektrolyt mit einer besseren Ladekapazität und der Möglichkeit mehr Ladezyklen (Startvorgänge) im Vergleich zu herkömmlichen Batterien durchzuführen. Sie eignen sich ideal für den Einsatz in Fahrzeugen mit Start-Stopp-System.

PT/ Baterias EFB (Enhanced Flooded Battery): baterias de eletrólitos líquidos com uma melhor capacidade de carga e que suportam um maior número de ciclos (arranques) do que as baterias convencionais. Ideais para veículos equipados com um sistema Start-Stop.

ES/ Baterías al Litio: baterías con un peso reducido, alta densidad de energía y bajísima autodescarga. Se utilizan sobre todo en el mundo del automovilismo.

DE/ Lithiumbatterien: gewichtsreduzierte Batterien mit hoher Energiedichte und sehr niedriger Selbstentladung. Sie finden hauptsächlich in der Welt des Motorsports Anwendung.

PT/ Baterias de lítio: baterias com peso reduzido, alta densidade de energia e auto-descarga muito baixa. São utilizados principalmente nos desportos motorizados.

BATTERY CONNECTION

SERIAL CONNECTION

CHARGE VOLTAGE = Sum of each voltage in V
Batteries need to have the same capacity in Ah

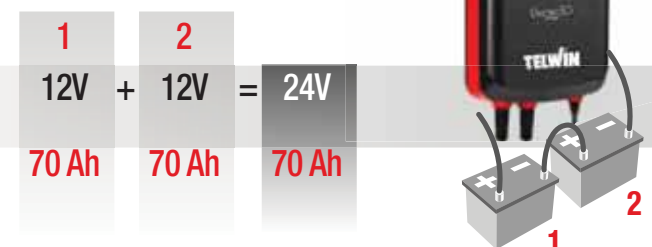

PARALLEL CONNECTION

CHARGE CAPACITY = Sum of each capacity in Ah
Batteries need to have the same voltage in V

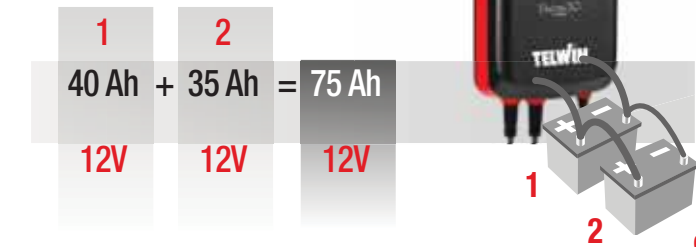

Wet

Gel

AGM

AGM+

EFB

Li

ELECTRONIC CONTROL OF CHARGE PROCESS

PULSE-TRONIC FUNCTIONING CURVES CURVE DI FUNZIONAMENTO IN PULSE-TRONIC

Pulse Tronic

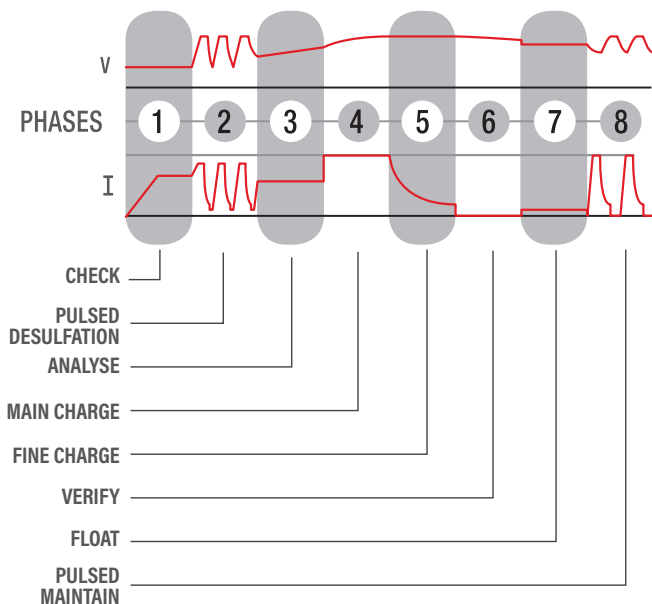

1 CHECK

EN/ Battery test
IT/ Test di batteria
FR/ Test de batterie

ES/ Prueba de batería
DE/ Batterietest
PT/ Teste de bateria

2 PULSED DESULFATION

EN/ Sulphated/very discharged battery pulse recovery
IT/ Recupero a impulsi batterie solfatate/molto scariche
FR/ Récupération par impulsions batteries sulfatées/très déchargées

ES/ Recuperación a impulsos de baterías sulfatadas/muy descargadas
DE/ Instandsetzung mittels Impulsen sulfatierter/stark entladener Batterien
PT/ Recuperação de baterias sulfatadas/muito descarregadas

3 ANALYSE

EN/ Integrity check
IT/ Controllo integrità
FR/ Contrôle intégrité

ES/ Control de la integridad
DE/ Prüfung auf einwandfreien Funktionszustand
PT/ Controlo de integridade

4 MAIN CHARGE

EN/ Charge up to 80%
IT/ Carica fino all'80%
FR/ Chargée jusqu'à 80%

ES/ Carga hasta el 80%
DE/ Laden auf 80%
PT/ Carga até 80%

5 FINE CHARGE

EN/ Charge up to 100%
IT/ Carica fino al 100%
FR/ Chargée jusqu'à 100%

ES/ Carga hasta el 100%
DE/ Laden auf 100%
PT/ Carga até 100%

6 VERIFY

EN/ Charge endurance monitoring
IT/ Monitor tenuta carica
FR/ Surveillance maintien charge

ES/ Monitoreo retención carga
DE/ Überwachung Ladungserhaltung
PT/ Monitorização da retenção da carga

7 FLOAT

EN/ Charge holding
IT/ Mantenimento carica
FR/ Maintien de la charge

ES/ Mantenimiento carga
DE/ Erhaltungsladung
PT/ Manutenção da carga

8 PULSED MAINTAINANCE

EN/ Pulsed charge recovery
IT/ Ripristino carica a impulsi
FR/ Rétablissement de la charge par impulsions

ES/ Restablecimiento carga a impulsos
DE/ Einhaltung des optimalen Ladezustandes mittels Impulsen
PT/ Recuperação da carga por impulsos



TRONIC FUNCTIONING CURVES CURVE DI FUNZIONAMENTO IN TRONIC

Tronic

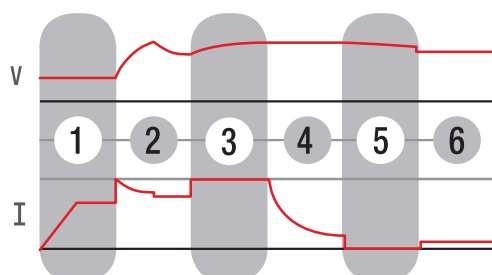

1 CHECK

3 MAIN CHARGE

5 VERIFY

2 DESULFATION

4 FINE CHARGE

6 FLOAT

T-CHARGE 12 - T-CHARGE 20



Pulse
Tronic



CHARGE & MAINTAIN



AGM



COLD



RECOVERY



SUPPLY



MORE INFO



mod. 20

mod. 20

mod. 20

STANDARD

802901



M6 - 802986



OPTIONAL

EYELETS

M6 - 802986

M8 - 804037



12V PLUG CONNECTOR
DUAL SIZE

804038



MAGNETS 2 PCS

mod. 20

803088

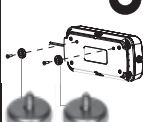

Wet Gel MF AGM Pb-Ca EFB

INTERCHANGEABLE CONNECTORS



TECHNICAL DATA

CE EAC	CODE	V _{1PH} V (50-60Hz)	P W	V	A _{EFF} A	A _{EN} A	Ah MIN	Ah MAX	IP	LxWxH cm	kg
T-CHARGE 12	807567	230 1 ph	55	6 / 12	1 / 4	1 / 4	2	70	IP65	17 x 6,5 x 3,5	0,6
T-CHARGE 20	807594	230 1 ph	115	12 / 24	8 / 4	8 / 4	5	180	IP65	27 x 12 x 6,7	1,3

EN/ Multifunction, electronic battery chargers and maintainers for WET, GEL, AGM, MF, PbCa, EFB batteries at 6/12V (mod. 12) and 12/24V (mod.20). Features: automatic charge and maintenance in Pulse Tronic - led signalling charge level - AGM function to charge and maintain AGM batteries - COLD function to charge and maintain batteries at low temperatures - RECOVERY function to recover sulphated batteries - SUPPLY function to grant stable supply during battery change (mod.20) - protections against overloads, short circuit and polarity reversal. Equipped with cable with clamps and cable with eyelets.

IT/ Caricabatterie e mantenitori di carica elettronici, multifunzione per batterie WET, GEL, AGM, MF, PbCa, EFB a 6/12V (mod. 12) e 12/24V (mod.20). Caratteristiche: carica e mantenimento automatici in Pulse Tronic - visualizzazione led del livello di carica - funzione AGM per la carica e mantenimento di batterie AGM - funzione COLD per la carica e mantenimento delle batterie a basse temperature - funzione RECOVERY per il recupero di batterie solfatate - funzione SUPPLY per l'alimentazione stabile durante i cambi batteria (mod.20) - protezioni contro sovraccarico, cortocircuito e inversione polarità. Completati di cavo con pinze e cavo con occhielli.

FR/ Chargeurs de batterie et de maintenance électroniques multifonction pour batteries WET, GEL, AGM, MF, PbCa, EFB à 6/12V (mod.12) et 12/24V (mod.20). Caractéristiques: charge et maintien de la charge automatiques en Pulse Tronic - affichage à led du niveau de charge - fonction AGM pour charger et l'entretien les batteries AGM - fonction COLD pour la charge et le maintien de la charge des batteries à basses températures - fonction RECOVERY pour la récupération de batteries sulfatées - fonction SUPPLY pour l'alimentation stable durant les changements de batterie (mod.20) - protections contre surcharge, court-circuit et inversion de polarité. Complets avec câble avec pinces et câble avec oeillets.

ES/ Cargadores de baterías y de mantenimiento electrónicos multifunción para baterías WET, GEL, AGM, MF, PbCa, EFB 6/12V (mod.12) y 12/24V (mod.20). Características: carga y mantenimiento automáticos en Pulse Tronic - pantalla led de nivel de carga - función AGM para la carga y el mantenimiento de baterías AGM - función COLD para la carga y el mantenimiento de baterías a bajas temperaturas - función RECOVERY para la recuperación de las baterías sulfatadas - función SUPPLY para alimentación estable durante los cambios de batería (mod.20) - protección contra sobrecarga, cortocircuito y inversión de polaridad. Equipados con cable con pinzas, cable con argollas.

DE/ Elektronische, multifunktionelle Batterielade-, und Erhaltungsladegeräte für Batterien vom Typ WET, GEL, AGM, MF, PbCa, EFB mit 6/12V (mod.12) und 12/24V (mod.20). Eigenschaften: automatisches Laden und Erhaltungsladen mit Pulse Tronic - LED-Anzeige des Ladezustands - AGM-Funktion zum Laden und Erhaltungsladen von AGM-Batterien - COLD-Funktion zum Laden und Erhaltungsladen von Batterien bei niedrigen Temperaturen - RECOVERY-Funktion zur Instandsetzung sulfatierter Batterien SUPPLY-Funktion für stabile Stromversorgung beim Batteriewechsel (mod.20) - Schutz gegen Überlast, Kurzschluss und Umpolung. Kabel mit Zangen und Kabel mit Ösen sind enthalten.

PT/ Aparelhos eletrónicos multifunções para carga e manutenção para baterias WET, GEL, AGM, MF, PbCa, EFB, Li a 6/12V (mod.12) e a 12/24V (mod.20). Características: carga automática e manutenção no Pulse Tronic - LED de visualização do nível de carga - função AGM para carga e manutenção de baterias AGM - função COLD para carga e manutenção de baterias a baixas temperaturas - função RECOVERY para recuperação de baterias sulfatadas - função SUPPLY para alimentação estável durante as mudanças de bateria (mod.20) - proteções contra sobrecarga, curto-circuito e inversão de polaridade. Completos com cabo com pinças e terminais redondos.

MMA WELDING

MIG-MAG WELDING

TIG WELDING

PLASMA CUTTING

SPOT WELDING

CHARGING & STARTING

INDEX

T-CHARGE 12 EVO - T-CHARGE 20 EVO - T-CHARGE 26 EVO



Pulse
Tronic



[www](http://www.telwin.it) MORE INFO



12V 24V

6V 12V

T-CHARGE 20 EVO
807596



12V 24V



mod. 20, 26 mod. 20, 26 mod. 20, 26

STANDARD

802901



M6 - 802986



OPTIONAL

EYELETS
M6 - 802986
M8 - 804037



12V PLUG CONNECTOR
DUAL SIZE
804038



MAGNETS 2 PCS
mod. 20 EVO, 26 EVO
803088

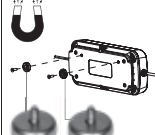

Wet Gel MF AGM Pb-Ca EFB **Li**

INTERCHANGEABLE CONNECTORS



TECHNICAL DATA

CE EAC	CODE	V _{1PH} V (50-60Hz)	P W	V	A _{EFF} A	A _{EN} A	Ah _{MIN} Ah	Ah _{MAX} Ah	IP	LxWxH cm	kg
T-CHARGE 12 EVO	807578	230 1ph	55	6 / 12	1 / 4	1 / 4	2	70	IP65	17 x 6,5 x 3,5	0,6
T-CHARGE 20 EVO	807596	230 1ph	115	12 / 24	8 / 4	8 / 4	5	180	IP65	27 x 12 x 6,7	1,4
T-CHARGE 26 EVO	807595	230 1ph	232	12 / 24	16 / 8	16 / 8	10	250	IP44	27 x 12 x 6,7	1,6

EN/ Multi-functional, electronic battery chargers, trickle chargers and testers for WET, GEL, AGM, MF, PbCa, EFB, Li batteries at 6/12V (mod. 12 Evo) and 12/24V (mod. 20-26-30-50 Evo), with LCD screen. Features: automatic charging and maintenance in Pulse Tronic based on the technology of the selected battery - BOOST function for quick charge (mod. 20-26-30-50 Evo) - COLD function for charging and maintenance of batteries at low temperatures - RECOVERY function to recover sulphated batteries - TEST function for battery, start-up and alternator - SUPPLY function for stable power supply during battery changing - LCD screen - protection against overloads, short circuit and polarity reversal. Complete with cable with clamps and cable with eyelets (mod. T-Charge).

IT/ Caricabatterie, mantenitori di carica e tester elettronici multifunzione per batterie WET, GEL, AGM, MF, PbCa, EFB, Li a 6/12V (mod.12 Evo) e a 12/24V (mod.20-26-30-50 Evo) con schermo lcd. Caratteristiche: carica e mantenimento automatico in Pulse Tronic in base alla tecnologia della batteria selezionata - funzione BOOST per la carica rapida (mod. 20-26-30-50 Evo) - funzione COLD per la carica e mantenimento delle batterie a basse temperature - funzione RECOVERY per il recupero di batterie solfatate - funzione TEST batteria, avviamento e alternatore - funzione SUPPLY per l'alimentazione stabile durante i cambi batteria - schermo LCD - protezioni contro sovraccarico, cortocircuito e inversione polarità. Completati di cavo con pinze e cavo con occhielli (mod. T-Charge).

FR/ Chargeurs de batterie, dispositifs de maintien de charge et testeurs électroniques multifonctions pour batteries WET, GEL, AGM, MF, PbCa, EFB, Li à 6 / 12V (mod.12 Evo) et à 12/24V (mod. 20-26-30-50 Evo) avec afficheur CL. Caractéristiques : charge et maintien de la charge automatiques en Pulse Tronic en fonction de la technologie de la batterie sélectionnée - fonction BOOST pour la charge rapide (mod. 20-26-30-50 Evo) - fonction COLD pour la charge et le maintien de la charge des batteries à basses températures - fonction RECOVERY pour la récupération de batteries sulfatées - fonction TEST batterie, démarrage et alternateur - fonction SUPPLY pour l'alimentation stable durant les changements de batterie - afficheur CL - protections contre surcharge, court-circuit et inversion de polarité. Fournis avec câble à pinces et câble à œillets (mod. T-Charge).

PULSE 30 EVO - PULSE 50 EVO



Pulse
Tronic



STANDARD

2m



OPTIONAL

WALL
SUPPORT KIT
803086



WALL



METALLIC SURFACE

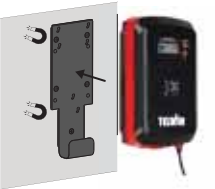

MAGNETS 3PCS
803087

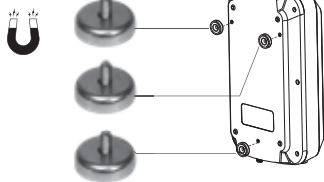

PULSE 30 EVO
807610



TECHNICAL DATA

	CE	ERAC	TUV	CODE	V _{1PH} V (50-60Hz)	P W	V V	A _{EFF} A	A _{EN} A	A _{1VC} A	Ah MIN	Ah MAX	IP	LxWxH cm	kg
PULSE 30 EVO				807610	230 1ph	369	12 / 24	27 / 15	25 / 12	25 (Boost)	5	400	IP33	9,2x20x33	3,1
PULSE 50 EVO				807611	230 1ph	610	12 / 24	45 / 23	40 / 20	40	10	600	IP33	9,2x20x33	3,2

ES/ Cargadores de baterías, mantenedores de carga y tester electrónicos multifunciones para baterías WET, GEL, AGM, MF, P bCa, EFB, Li d e 6 /12V (mod.12 Evo) y d e 12/24V (mod. 20-26-30-50 Evo) con pantalla LCD. Características: carga y mantenimiento automáticos en Pulse Tronic según la tecnología de la batería seleccionada · función BOOST para la carga rápida (mod. 20-26-30-50 Evo) · función COLD para la carga y el mantenimiento de baterías a bajas temperaturas · función RECOVERY para la recuperación de las baterías sulfatadas · función TEST de batería, arranque y alternador · función SUPPLY para alimentación estable durante los cambios de batería · pantalla LCD · protecciones contra sobrecarga, cortocircuito e inversión de polaridades. Equipados con cable con pinzas y cables con argollas (mod. T-Charge).

DE/ Elektronische, multifunktionelle Batterielade-, Erhaltungslade und Testgeräte für Batterien vom Typ WET, GEL, AGM, MF, PbCa, EFB, Li mit 6/12V (mod.12 Evo) und 12/24V (mod. 20-26-30-50 Evo), mit LCD-Bildschirm. Eigenschaften: basierend auf der ausgewählte Batterietechnologie automatisches Laden und Erhaltungsladen mit Pulse Tronic · BOOST-Funktion zur schnellen Aufladung (mod. 20-26-30-50 Evo) · COLD-Funktion zum Laden und Erhaltungsladen von Batterien bei niedrigen Temperaturen · RECOVERY-Funktion zur Instandsetzung sulfatierten Batterien · TEST-Funktion zum Testen von Batterie, Startleistung und Drehstromlichtmaschine · SUPPLY-Funktion zur konstanten Stromversorgung während der Batteriewechsel · LCD-Bildschirm · Schutz gegen Überlast, Kurzschluss und Umpolung. Kabel mit Zangen und Kabel mit Ösen sind enthalten (mod. T-Charge).

PT/ Aparelhos eletrônicos multifunções para carga, manutenção e teste, para baterias WET, GEL, AGM, MF, PbCa, EFB, Li a 6/12V (mod.12 Evo) e a 12/24V (mod.20-26-30-50 Evo) com ecrã LCD. Características: carga automática e manutenção no Pulse Tronic com base na tecnologia de bateria selecionada · função BOOST para carga rápida (mod. 20-26-30-50 Evo) · função COLD para carga e manutenção de baterias a baixas temperaturas · função RECOVERY para recuperação de baterias sulfatadas · função TEST para baterias, arranque e alternador · função SUPPLY para alimentação estável durante as mudanças de bateria · ecrã LCD · proteções contra sobrecargas, curto-circuito e inversão de polaridade. Completos com cabo com pinças e terminais redondos (mod. T-Charge).

MMA WELDING

MIG-MAG WELDING

TIG WELDING

PLASMA CUTTING

SPOT WELDING

CHARGING & STARTING

INDEX

EN/ Doctor Charge is much more than a battery charger, it is a BATTERY MANAGER always supporting the professional in all charging, battery care and diagnostic activities.

IT/ Doctor Charge è molto più di un caricabatterie, è il BATTERY MANAGER sempre a fianco del professionista in tutte le attività di carica, cura della batteria e di diagnostica.

FR/ Doctor Charge est bien plus qu'un chargeur de batterie, il est le BATTERY MANAGER toujours aux côtés du professionnels dans toutes les opérations de charge, entretien de la batterie et de diagnostic.

ES/ Doctor Charge es mucho más que un cargador de baterías, es el GESTOR DE BATERÍAS siempre al lado del profesional en todas las actividades de carga, cuidado de la batería y diagnóstico.

DE/ Doctor Charge ist der BATTERY MANAGER und viel mehr als ein Batterieladegerät. Er ist immer an der Seite des professionellen Anwenders bei allen Aktivitäten des Ladens, der Batterieinstandhaltung und der Diagnostik.

PT/ O Doctor Charge é muito mais do que um carregador de bateria, é o GESTOR DE BATERIAS sempre ao lado do profissional em todas as actividades de carga, manutenção da bateria e diagnóstico.

DISCOVER ALL THE FUNCTIONS

Pulse
Tronic



CHARGE &
MAINTAIN



BOOST



COLD

EN/ Curves dedicated to battery technology

IT/ Curve dedicate alla tecnologia della batteria

FR/ Courbes concernant la technologie de la batterie

ES/ Curvas dedicadas a la tecnología de la batería

DE/ Bei der Batterietechnologie vorgesehene Kurven

PT/ Curvas dedicadas à tecnologia de baterias



DIAGNOSTIC
& SUPPLY

EN/ Stable power supply for diagnostics, during battery changing and show rooms

IT/ Sorgente di alimentazione stabile per attività di diagnostica, cambi batteria e show room

FR/ Alimentation stable pour le diagnostic, changement de la batterie et salles d'exposition

ES/ Fuente de alimentación estable para el diagnóstico, en los cambios de la batería y salas de exposición

DE/ Stabile Stromversorgung für Diagnosezwecke, während des Batterieaustausches und in Ausstellungsräumen

PT/ Fonte de energia estável para diagnóstico, mudança de bateria e salas de exposição



TEST

EN/ Battery, starter and alternator tests

IT/ Test di batteria, avviamento e alternatore

FR/ Tests de la batterie, du démarreur et de l'alternateur

ES/ Pruebas de batería, arranque y alternador

DE/ Batterie-, Anlauf- und Lichtmaschinentests

PT/ Testes de bateria, arrancador e alternador



RECOVERY

DESULFATION & EQUALIZATION

EN/ Battery restoration and recovery

IT/ Ripristino e recupero delle batterie

FR/ Restauration et récupération des batteries

ES/ Restauración y recuperación de la batería

DE/ Instandsetzung und Wiederherstellung von Batterien

PT/ Restauro e recuperação de baterias



START

EN/ Starting (starting aid mod. 50)

IT/ Avviamento (aiuto mod. 50)

FR/ Démarrage (aide au démarrage mod. 50)

ES/ Arranque (ayuda al arranque mod. 50)

DE/ Start (Starthilfe mod. 50)

PT/ Arranque (ajuda ao arranque mod. 50)



DIAGNOSTIC & SUPPLY



DIAGNOSTIC (BSU)



DIAGNOSTIC

EN/ Stable power supply for diagnostics with output voltage adjustment.

IT/ Alimentatore stabile per attività di diagnostica con regolazione del voltaggio in uscita.

FR/ Alimentation stable pour le diagnostic avec régulation de la tension de sortie.

ES/ Fuente de alimentación estable para el diagnóstico con regulación de la tensión de salida.

DE/ Stabile Stromversorgung für Diagnosezwecke mit Ausgangsspannungsregelung.

PT/ Fonte de alimentação estável para operações de diagnóstico com regulação da tensão de saída.

SHOW ROOM



SHOW ROOM

EN/ Power source for demonstration vehicles on display in showrooms.

IT/ Fonte di energia per alimentare i veicoli dimostrativi esposti negli showroom.

FR/ Source d'énergie pour alimenter les véhicules de démonstration exposés dans les salles d'exposition.

ES/ Fuente de energía para alimentar los vehículos de demostración expuestos en las salas de exposición.

DE/ Energiequelle zum Antrieb von Demonstrationsfahrzeugen, die in Ausstellungsräumen gezeigt werden.

PT/ Fonte de energia para manter em condição excelente as baterias dos veículos de demonstração expostos nos salões de exposição.

SUPPLY



SUPPLY

EN/ Power supply to maintain the on-board electronics when changing the battery.

IT/ Mantenimento dell'alimentazione dell'elettronica del veicolo nei cambi della batteria.

FR/ Maintien de l'électronique du véhicule lors du changement de la batterie.

ES/ Mantenimiento de la alimentación de los dispositivos electrónicos del vehículo en los cambios de la batería.

DE/ Stabilisierte Stromversorgung während des Batterieaustausches.

PT/ Manutenção da alimentação da eletrónica do veículo nas trocas da bateria.

RECOVERY



DESULFATION



DESULFATION

EN/ Pulse process for the recovery of sulphated batteries.

IT/ Processo ad impulsi per il recupero di batterie solfatate.

FR/ Processus d'impulsions pour la récupération de batteries sulfatées.

ES/ Proceso por impulsos para la recuperación de baterías sulfatadas.

DE/ Puls verfahren zur wiederinstandsetzung sulfatierter batterien.

PT/ Processo por impulsos para a recuperação de baterias sulfatadas.

EQUALIZATION



EQUALIZATION

EN/ Restoring optimal battery health by remixing the elements.

IT/ Ripristino dello stato di salute ottimale della batteria rimescolando gli elementi.

FR/ Rétablissement de la santé optimale de la batterie en mélangeant les éléments.

ES/ Recuperación de la salud óptima de la batería mezclando los elementos.

DE/ Wiederherstellung einer optimalen batteriefunktion durch aufrühren der elemente.

PT/ Recuperação da condição ótima da bateria misturando os elementos.

CALIBRATION OF CABLES



EN/ Calibration of cables to ensure correct operation.

IT/ Calibrazione dei cavi per garantire una corretta operatività.

FR/ Calibrage des câbles pour assurer un fonctionnement correct.

ES/ Calibración de los cables para garantizar su correcto funcionamiento

DE/ Kalibrierung von kablern zur gewährleistung eines korrekten betriebs

PT/ Calibragem dos cabos em função dos diferentes comprimentos para garantir o funcionamento correto.

EN/ BatteryConnect is the application for Doctor Charge Connect, allowing you to save and manage the results of battery and alternator testing and monitor the charge.

IT/ BatteryConnect è l'applicazione per Doctor Charge Connect che consente di gestire e salvare i risultati dei test di batteria e dell'alternatore e di monitorare la carica.

FR/ BatteryConnect est l'application pour Doctor Charge Connect qui permet de gérer et d'enregistrer les résultats des tests de batterie et de l'alternateur, et de surveiller la charge.

ES/ BatteryConnect es la aplicación para Doctor Charge Connect que permite gestionar y guardar los resultados de los tests de batería y del alternador y efectuar un seguimiento de la carga.

DE/ BatteryConnect ist die Anwendung für Doctor Charge Connect, die die Möglichkeit bietet, die Testergebnisse der Batterie und des Drehstromgenerators zu speichern und das Laden zu überwachen.

PT/ BatteryConnect é a aplicação Doctor Charge Connect para gerir e guardar resultados de testes de bateria e alternador e monitorizar a carga.

SAVE AND SHARE TEST REPORTS

EN/ Select a test (battery voltage performance, starting efficiency, vehicle alternator, charge status and condition of the battery), start it and view the results in a clear and simple manner. The test reports can be shared, saved and archived.

IT/ Seleziona un test (andamento tensione batteria; capacità avviamento; alternatore del veicolo; stato di carica e di salute della batteria), avvialo e visualizza in modo semplice e chiaro i risultati. I report dei test possono essere condivisi, salvati e archiviati.

FR/ Sélectionnez un test (évolution tension batterie, capacité démarrage, alternateur du véhicule, état de charge et de santé de la batterie), lancez-le et affichez de façon simple et claire les résultats. Les rapports des tests peuvent être partagés, enregistrés et stockés.

ES/ Selecciona un test (evolución de tensión de batería, capacidad de arranque, alternador del vehículo, estado de carga y de salud de la batería), ponlo en marcha y visualiza de manera sencilla y clara los resultados. Los informes de las pruebas pueden compartirse, guardarse y archivarlos.

DE/ Wählen Sie einen Test (Batteriespannungsverlauf, Startleistung, Fahrzeugdrehstromgenerator, Ladezustand und Gesundheitszustand der Batterie), starten Sie ihn und die Ergebnisse werden einfach und klar angezeigt. Die Testberichte können geteilt, gespeichert und archiviert werden.

PT/ Selecionar um teste (desempenho da tensão da bateria; capacidade de arranque; alternador do veículo; estado de carga e condição da bateria), iniciá-lo e visualizar os resultados de uma forma clara e simples. Os relatórios de teste podem ser partilhados, guardados e arquivados.



* To perform health test, you will need the "Battery test cable" supplied with Doctor Charge 55 Connect. - Per eseguire il test di prestazione ti servirà il cavo "Battery test cable" in dotazione con Doctor Charge 55 Connect. - Pour exécuter le test de performance, le câble « Battery test cable » fourni avec Doctor Charge 55 Connect est nécessaire. - Para efectuar el test de prestación, necesitas el cable "Battery test cable" incluido con Doctor Charge 55 Connect. - Zum Durchführen des Leistungstests benötigen Sie das Kabel „Battery test cable“, das im Lieferumfang von Doctor Charge 55 Connect enthalten ist. - Para realizar o teste de desempenho necessitará do 'cabo de teste de bateria' fornecido com o Doctor Charge 55 Connect

MONITOR AND MANAGE CHARGE



DOWNLOAD BATTERYCONNECT APP
SCARICA BATTERYCONNECT APP

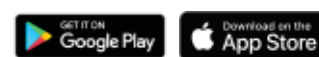

App name: **BatteryConnect**

* ONLY FOR DOCTOR CHARGE 55 CONNECT

DOCTOR CHARGE 55 CONNECT



Pulse Tronic



CHARGE & MAINTAIN



TEST



RECOVERY



SUPPLY



START AID

FOR MORE FUNCTIONS DOWNLOAD:

BATTERYCONNECT APP

- LIVE TRACKING
- TEST REPORT SHARING
- ADVANCED FEATURES



via BT

OPTIONAL

WALL SUPPORT KIT
803086



MAGNETS 3PCS
803087



CHARGING CABLES
6m 804390
10m 804391



TECHNICAL DATA



	CODE	V _{1PH} V (50-60Hz)	P W	V	A _{EFF} A	A _{EN} A	A _{1V/C} A	Ah _{MIN} Ah	Ah _{MAX} Ah	IP	LxWxH cm	kg
DOCTOR CHARGE 55 CONNECT	807614	230 1ph	610	6 / 12 / 24	45 / 45 / 23	40 / 40 / 20	40 (Boost)	10	600	IP33	9,2x20x33	4



STANDARD

3m



BATTERY TESTER CABLE



EN/ Electronic BATTERY MANAGERS for total maintenance of WET, GEL, AGM, MF, PbCa, EFB and Li batteries at 6V/12V/24V and for support activities when intervening on vehicles in workshops, repair shops and car dealer premises. Functions: automatic charging and maintenance PULSE-TRONIC - battery, starting and alternator testing - regeneration and recovery of batteries - stable power source for battery changes (to protect the on-board electronics), for diagnostic activities and showrooms - start aid (start mod. 130) - mod. 55 Connect: Dedicated App for additional testing and charge monitoring functions.

IT/ Caricabatterie elettronici multifunzione (BATTERY MANAGER) per la completa manutenzione di batterie WET, GEL, AGM, MF, PbCa, EFB e Li a 6V/12V/24V e per attività di supporto negli interventi sui veicoli effettuati nelle officine, carrozzerie e concessionarie. Funzioni: carica e mantenimento automatico PULSE-TRONIC - test di batteria, avviamento e alternatore - rigenerazione e recupero di batterie - sorgente di alimentazione stabile per cambi batteria (salvaguardia elettronica di bordo), attività di diagnostica e showroom - aiuto avviamento (avviamento mod. 130) - mod. 55 Connect: App dedicata per funzionalità aggiuntive di test e monitoraggio della carica.

MMA WELDING

MIG-MAG WELDING

TIG WELDING

PLASMA CUTTING

SPOT WELDING

CHARGING & STARTING

INDEX

DOCTOR CHARGE 50



Pulse
Tronic



NEW

STANDARD

3m



BATTERY TESTER CABLE



OPTIONAL

WALL SUPPORT KIT
803086



MAGNETS 3PCS
803087



CHARGING CABLES
6m 804390
10m 804391



DIAGNOSTIC TROLLEY
803077



TECHNICAL DATA

CE	EAC	TUV SUD	CODE	V _{1PH} V (50-60Hz)	P W	V V	A _{EFF} A	A _{EN} A	A _{TW/C} A	Ah _{MIN} Ah	Ah _{MAX} Ah	IP	LxWxH cm	kg
			DOCTOR CHARGE 50	230 1ph	610	6 / 12 / 24	45 / 45 / 23	40 / 40 / 20	40 (Boost)	10	600	IP33	9,2x20x33	3,8

FR/ Chargeurs de batterie électroniques multifonctions (BATTERY MANAGER) pour l'entretien complet de batteries WET, GEL, AGM, MF, PbCa, EFB et Li à 6V/12V/24V et pour des activités de support dans les interventions sur les véhicules effectuées dans les ateliers, carrosseries et chez les concessionnaires. Fonctions: charge et maintien automatique PULSE-TRONIC - test de batterie, démarrage et alternateur - récupération et rétablissement de batteries - source d'alimentation stable pour les changements de batterie (sauvegarde électronique de bord), activités de diagnostic et salles d'exposition - aide au démarrage (démarrage mod. 130) - mod. 55 Connect: App dédiée pour des fonctions supplémentaires de test et de contrôle de la charge.

ES/ Cargadores de baterías electrónicos multifunción (BATTERY MANAGER) para el mantenimiento completo de baterías WET, GEL, AGM, MF, PbCa, EFB y Li de 6V/12V/24V y para actividades de soporte en las intervenciones en los vehículos realizadas en los talleres mecánicos y de carrocería y en las concesionarias. Funciones: carga y mantenimiento automático PULSE-TRONIC - pruebas de batería, arranque y alternador - restablecimiento y recuperación de baterías - fuente de alimentación estable para los cambios de batería (salvaguardia electrónica de bordo), actividades de diagnóstico y showrooms - ayuda arranque (arranque mod. 130) - mod. 55 Connect: Aplicación dedicada para funciones adicionales de comprobación y control de la carga.

DOCTOR CHARGE 130



Pulse Tronic



CHARGE & MAINTAIN



TEST



RECOVERY



SUPPLY & DIAGNOSTIC



START

STANDARD

3m
981805



OPTIONAL

WALL SUPPORT
803086



CHARGING CABLES

6m 802945
10m 802946



DIAGNOSTIC TROLLEY
803077



12V 24V

Wet Gel MF AGM Pb-Ca EFB **Li**

TECHNICAL DATA

CE EAC	CODE	V _{1PH} V (50-60Hz)	P _{CHARGE} kW	P _{START} kW	V	A _{EFF} A	A _{EN} A	A _{1V/C} A	Ah _{MIN} Ah	Ah _{MAX} Ah	☀️	LxWxH cm	kg
DOCTOR CHARGE 130	807599	230 1ph	1,8	2	12 / 24	140 / 70	120 / 60	180	20	1200	7	20 x 26 x 34	6

DE/ Multifunktions-, Elektronische-Batterieladegeräte (BATTERY MANAGER) für die komplette Wartung der Batterietypen WET, GEL, AGM, MF, PbCa, EFB und Li mit 6V/12V/24V sowie für arbeitsunterstützende Funktionen bei Arbeiten am Fahrzeug, die in Werkstätten, Karosserien und Vertragshändlern ausgeführt werden. Funktionen: automatisches Laden und Erhaltungsladen PULSE-TRONIC • Batterie-, Start- und Drehstromlichtmaschine Test • Instandsetzung und Wiederherstellung von Batterien • geregelte Spannungsquelle bei Batteriewechseln (Schutz der Bordelektronik), Diagnostetätigkeiten und Ausstellungsräumen • Hilfsstart (Start Mod. 130) • Mod. 55 Connect: Dedizierte App für zusätzliche Test- und Ladeüberwachungsfunktionen.

PT/ GESTORES DE BATERIAS eletrônicos para manutenção total de baterias WET, GEL, AGM, MF, PbCa, EFB e Li a 6V/12V/24V e como auxílio em intervenções em oficinas, oficinas de carroçaria e stands de automóveis. Funções: carga e manutenção automáticas PULSE-TRONIC • teste de bateria, arranque e alternador • regeneração e recuperação de baterias • fonte de alimentação estável para troca de baterias (para proteção dos dispositivos eletrônicos dos veículos), em operações de diagnóstico e salões de exposição • ajuda ao arranque (arranque mod. 130) • mod. 55 Connect: Aplicação específica para funções adicionais de teste e controlo de carga.

MMA WELDING
MIG-MAG WELDING
TIG WELDING
PLASMA CUTTING
SPOT WELDING
CHARGING & STARTING
INDEX

DOCTOR START 330



Pulse
Tronic

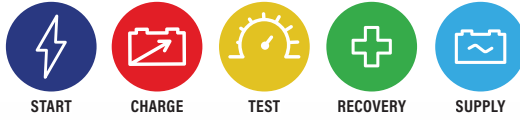

MORE INFO



TECHNICAL DATA

CE EAC	CODE	V _{1PH}	P _{CHARGE}	P _{START}	V	A _{EFF}	A _{EN}	A _{1V/C}	A _{START MAX}	Ah _{MIN}	Ah _{MAX}	LxWxH	kg
		V (50-60Hz)	KW	KW	V	A	A	A	A	Ah	Ah	cm	kg
DOCTOR START 330	829341	230 1ph	1	6,4	12 / 24	45	31	180	300	10	450	30,5 x 36 x 63	12,5

OPTIONAL

FUSES - 20 pcs
50A - 802259



EN/ Multifunction, electronic battery chargers, starters and testers for WET, GEL, AGM, MF, PbCa, EFB and Li batteries at 12V/24V. They grant complete maintenance of WET, GEL, AGM, MF, PbCa, EFB and Li batteries and quick starting of cars, vans and light trucks. They are an indispensable tool for stable power supply during battery changes. Easy and intuitive to use thanks to the graphical LCD screen. Features: automatic charging and maintenance in Pulse Tronic • battery, start and alternator test • regeneration and recovery of batteries • stable power source for battery changes • safeguard of the on-board electronics • starting of all types of cars, vans, light trucks.

IT/ Caricabatterie elettronici multifunzione, avviatori e tester per batterie WET, GEL, AGM, MF, PbCa, EFB e Li con tensione di 12V/24V. Garantiscono la completa manutenzione di batterie WET, GEL, AGM, MF, PbCa, EFB e Li e l'avviamento rapido di tutti i tipi di autovetture, furgoni, autocarri leggeri. Diventano strumento indispensabile per l'alimentazione stabile durante il cambio batteria. Uso facile ed intuitivo grazie allo schermo grafico LCD. Caratteristiche: Carica e mantenimento automatici in Pulse Tronic • test di batteria, avviamento e alternatore • rigenerazione e recupero batterie • sorgente di alimentazione stabile per cambi batteria • salvaguardia elettronica di bordo • avviamento di tutti i tipi di autovetture, furgoni, autocarri leggeri.

FR/ Chargeurs de batteries électroniques multifonction, démarreurs et testeurs pour batteries WET, GEL, AGM, MF, PbCa, EFB et Li avec tension de 12V / 24V. Ils garantissent l'entretien complet de batteries WET, GEL, AGM, MF, PbCa, EFB et Li et le démarrage rapide de tous les types de voitures, fourgons, camions légers. Ils deviennent un instrument indispensable pour une alimentation stable durant le changement de batterie. Utilisation facile et intuitive grâce à l'afficheur graphique LCD. Caractéristiques: charge automatique et maintenance en Pulse Tronic • test de batterie, démarrage et alternateur • récupération et rétablissement de batteries • source d'alimentation stable pour les changements de batterie • sauvegarde électronique de bord • démarrage de tous les types de voitures, fourgons, camions légers.

DOCTOR START 530 - DOCTOR START 630



Pulse *Tronic*

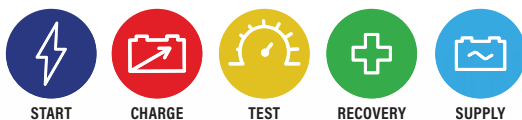

MORE INFO



WATCH THE VIDEO



TECHNICAL DATA

CE EAC	CODE	V _{IPH}	P _{CHARGE}	P _{START}	V	A _{EFF}	A _{EN}	A _{TV/C}	A _{START MAX}	Ah _{MIN}	Ah _{MAX}	LxWxH	kg
		V (50-60Hz)	KW	KW	V	A	A	A	A	Ah	Ah	cm	kg
DOCTOR START 530	829343	230 1ph	1,6	10	12 / 24	75	50	300	400	10	1000	36,5 x 46 x 75,5	19,5
DOCTOR START 630	829342	230 1ph	2	10	12 / 24	90	70	360	570	10	1550	36,5 x 46 x 75,5	23,4

OPTIONAL

FUSES - 20 pcs

80A mod. Doctor Start 530
802260

100A mod. Doctor Start 630
802029



ES/ Cargadores electrónicos multifunción, arrancadores y tester para baterías WET, GEL, AGM, MF, PbCa, EFB y Li con tensión de 12V/24V. Garantizan el completo mantenimiento de baterías WET, GEL, AGM, MF, PbCa, EFB y Li y el arranque rápido de todos los tipos de coches, furgonetas, camiones ligeros. Es un instrumento indispensable para alimentación estable durante el cambio de batería. Uso fácil e intuitivo gracias a la pantalla gráfica LCD. Características: carga y mantenimiento automáticos en Pulse Tronic • test de batería, arranque y alternador • restablecimiento y recuperación de baterías • fuente de alimentación estable para los cambios de batería • salvaguardia electrónica de bordo • arranque de todos los tipos de coches, furgonetas, camiones ligeros.

DE/ Elektronische, Multifunktionsladegeräte, Starter und Tester für Batterien des Typs WET, GEL, AGM, MF, PbCa, EFB und Li mit einer Spannung von 12V/24V. Stellen die vollständige Wartung der Batterien vom Typ WET, GEL, AGM, MF, PbCa, EFB und Li und einen Schnellstart aller Arten von Autos, Lieferwagen und leichten LKWs sicher. Unverzichtbare Werkzeuge eine konstante Stromversorgung beim Batteriewechsel zu unterstützen. Mit dem LCD-Bildschirm wird die Anwendung einfach und intuitiv. Eigenschaften: automatisches Laden und Erhaltungsladen mit Pulse Tronic • Test-Funktion von Batterie, Startleistung und Drehstromlichtmaschine • Instandsetzung und Wiederherstellung von Batterien • geregelte Spannungsquelle bei Batteriewechseln • Schutz der Bordelektronik • Starten aller Arten von Autos, Lieferwagen und leichten LKWs.

PT/ Carregadores, arrancadores e aparelhos de teste eletrônicos e multifunções para baterias WET, GEL, AGM, MF, PbCa, EFB e Li a 12V/24V. Manutenção completa e arranque rápido de furgonetas e carrinhas. Indispensáveis como fonte de alimentação estável em operações de troca de baterias. Utilização fácil e intuitiva graças ao monitor LCD gráfico. Características: carga e manutenção automáticas em Pulse Tronic • teste de bateria, arranque e alternador • regeneração e recuperação de baterias • fonte de alimentação estável para troca de baterias • proteção dos dispositivos eletrônicos do veículo • arranque de todo o tipo de automóveis, camionetas, carrinhas.

MMA WELDING

MIG-MAG WELDING

TIG WELDING

PLASMA CUTTING

SPOT WELDING

CHARGING & STARTING

INDEX

DYNAMIC 320 - 420 - 520 - 620 START



TECHNICAL DATA

CE EAC	CODE	V _{1PH} V (50-60Hz)	P _{CHARGE} kW	P _{START} kW	V	A _{EFF} A	A _{EN} A	A _{1V/C} A	A _{START MAX} A	Ah _{MIN} Ah	Ah _{MAX} Ah	☀️	LxWxH cm	kg
DYNAMIC 320 START	829381	230 1ph	1	6,4	12 / 24	45	31	180	300	20	700	3	30,5 x 36 x 63	13,4
DYNAMIC 420 START	829382	230 1ph	2	12	12 / 24	90	60	300	400	20	1000	4	30,5 x 36 x 63	16,4
DYNAMIC 520 START	829383	230 1ph	2	12	12 / 24	90	60	300	400	20	1000	4	36,5 x 46 x 75,5	20
DYNAMIC 620 START	829384	230 1ph	2	10	12 / 24	90	70	360	570	20	1550	4	36,5 x 46 x 75,5	24

OPTIONAL

FUSES - 20 pcs

- 50A mod. Dynamic 320 Start 802259
- 80A mod. Dynamic 420, 520 Start 802260
- 100A mod. Dynamic 620 Start 802029



EN/ Battery chargers and starters for charging lead-acid storage batteries (WET/START-STOP) with 12/24V voltage and starting all kinds of cars, vans and light trucks. Features: choice of normal charge, quick charge (BOOST), quick start - timer for quick charge (mod. 520, 620) - display of charging and starting current - protection against overloads and polarity reversal.

IT/ Caricabatterie e avviatori per la carica di accumulatori al piombo (WET/START-STOP) con tensione di 12/24V e l'avviamento rapido di tutti i tipi di autovetture, furgoni, autocarri leggeri. Caratteristiche: selezione carica normale, carica rapida (BOOST), avviamento rapido - temporizzatore per la carica rapida (mod. 520, 620) - visualizzazione della corrente di carica e di avviamento - protezione contro sovraccarichi ed inversioni di polarità.

FR/ Chargeurs de batterie et démarreurs pour charger les accumulateurs au plomb (WET/START-STOP) avec tension 12/24V et le démarrage de tous les types de voitures, fourgons et camions légers. Caractéristiques : sélecteur pour charge normale et rapide (BOOST), démarrage rapide - temporisateur pour charge rapide (mod. 520, 620) - affichage du courant de charge et de démarrage - protection contre surcharges et inversions de polarité.

ES/ Cargadores de baterías y arrancadores para la carga de acumuladores de plomo (WET/START-STOP) con tensión 12/24V y para el arranque de todos automoviles, furgonetas y camiones ligeros. Características: selección de carga normal, carga rápida (BOOST), arranque rápido - temporizador para carga rápida (mod. 520, 620) - visualización de la corriente de carga y de arranque - protección contra sobrecargas y inversiones de polaridad.

DE/ Batterieladegeräte und Starter zum Aufladen von Bleiakumulatoren (WET/START-STOP) mit 12/24V Spannung und Anlassen aller Typen von Fahrzeugen, Lieferwagen und Kleinlastern. Eigenschaften: Auswahlschalter für normale-, schnelle (BOOST) Aufladung, Schnellstart - Zeitschalter für Schnellaufladung (mod. 520, 620) - Anzeige Lade- und Anlaßstrom - Schutz gegen Überlastung und Umpolung.

PT/ Carregadores e arrancadores de bateria para carga de acumuladores de chumbo (WET/START-STOP) com 12V/24V e arranque de todo o tipo de automóveis, camionetas e carrinhas. Características: seleção entre carga normal, carga rápida (BOOST), arranque rápido - temporizador para carga rápida (mod. 520, 620) - visualização da corrente de carga e arranque - proteção contra sobrecargas e inversão de polaridade.

ENERGY 650 START - 1000 START - 1500 START



ENERGY 1000 START 829008



TECHNICAL DATA

CE	EAC	CODE	V _{3PH}	P _{CHARGE}	P _{START}	V	A _{EFF}	A _{EN}	A _{1V/C}	A _{START MAX}	Ah _{MIN}	Ah _{MAX}	☀	LxWxH	kg
			V (50-60Hz)	kW	kW	V	A	A	A	A	Ah	Ah		cm	kg
		ENERGY 650 START	230 / 400 3ph	2,5	20	12 / 24	100	80	640	1000	20	1600 (12V) 800 (24V)	5	36,5 x 46 x 75,5	38
		ENERGY 1000 START	230 / 400 3ph	2,5	20	12 / 24	100	80	640	1000	20	1600 (12V) 800 (24V)	5	38 x 56 x 88,5	45
		ENERGY 1500 START	230 / 400 3ph	7	44	12 / 24	150 (12V) 250 (24V)	130 (12V) 220 (24V)	1000 (12V) 1300 (24V)	1700 (12V) 2000 (24V)	70	2200 (12V) 4000 (24V)	6	38 x 56 x 88,5	69

OPTIONAL

FUSES - 10 pcs

100A	mod. Energy 650 Start
802131	
300A	mod. Energy 1000 Start, 1500 Start
802129	



EN/ Battery chargers and starters for charging lead-acid storage batteries (WET/START-STOP) with 12V/24V voltage and starting all kinds of cars, vans, light trucks, earth moving equipment, tractors and trucks. Features: choice of normal charge, quick charge (BOOST), quick start - timer for quick charge - remote control - display of charging and starting current - protection against overloads and polarity reversal.

IT/ Carica batterie e avviatori per la carica di accumulatori al piombo (WET/START-STOP) con tensione di 12V/24V e l'avviamento rapido di tutti i tipi di autovetture, furgoni, autocarri leggeri, macchine movimento terra, trattori e camion. Caratteristiche: selezione carica normale, carica rapida (BOOST), avviamento rapido - temporizzatore per la carica rapida - comando a distanza - visualizzazione della corrente di carica e di avviamento - protezione contro sovraccarichi ed inversioni di polarità.

FR/ Chargeurs de batterie et démarreurs pour charger les accumulateurs au plomb (WET/STARTSTOP) avec tension 12V/24V et le démarrage de tous les types de voitures, fourgons, camions légers, tracteurs et camions. Caractéristiques: sélecteur pour charge normale et rapide (BOOST), démarrage rapide - temporisateur pour charge rapide - commande à distance - affichage du courant de charge et de démarrage - protection contre surcharges et inversions de polarité.

ES/ Cargadores de baterías y arrancadores para la carga de acumuladores de plomo (WET/START-STOP) con tensión 12V/24V y para el arranque de todo tipo de automoviles, furgonetas, camiones ligeros, maquinas para el movimiento de tierras, tractores y camiones. Características: selección de carga normal, carga rápida (BOOST), arranque rápido - temporizador para la carga rápida - control a distancia - visualización de la corriente de carga y de arranque - protección contra sobrecargas y inversiones de polaridad.

DE/ Batterieladegeräte und Starter zum Aufladen von Bleiakumulatoren (WET/START-STOP) mit 12V/24V Spannung und Anlassen aller Typen von Fahrzeugen, Lieferwagen, Maschinen zur Bewegung von Erreich, Kleinlastern, Traktoren und LKW. Eigenschaften: Auswahlwähler für normale-, schnelle (BOOST) Aufladung, Schnellstart - Zeitschalter für Schnellaufladung - Fernsteuerung - Anzeige Lade- und Anlaßstrom - Schutz gegen Überlastung und Umpolung.

PT/ Carregadores e arrancadores para carga de acumuladores de chumbo (WET/START-STOP) com 12V/24V e arranque de todos os tipos de automóveis, camionetas, carrinhas, veículos de terraplanagem, tratores e camiões. Características: seleção entre carga normal, carga rápida (BOOST) e arranque rápido - temporizador para carga rápida - controlo remoto - visualização da corrente de carga e arranque - proteção contra sobrecargas e inversão de polaridade.

MMA WELDING

MIG-MAG WELDING

TIG WELDING

PLASMA CUTTING

SPOT WELDING

CHARGING & STARTING

INDEX

DRIVE 1500 - DRIVE 1750 XC



POWER BANK

USB A - QUICK CHARGE
USB C - POWER DELIVERY - Mod. 1750
WIRELESS - Mod. 1750
12V - Mod. 1500



2 led lights (4 modes)

FIX, BLINK, SOS, STROBE

DRIVE 9000

829565



NEW



WATCH THE VIDEO

STANDARD

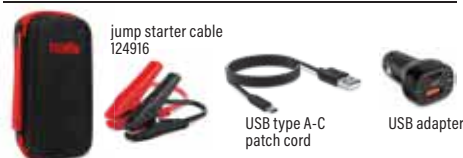

OPTIONAL

OBDD II - MEMORY SAVER CABLE
802935

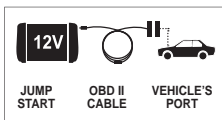

ACCESSORIES KIT
803537



TECHNICAL DATA

CE EAC	CODE	START	A ^{START} MAX	Power bank	A ^{OUT}	Power Bank ((∞))	Power Bank 12V	G	LxWxH	kg
		V	A		W	W	A	mAh	cm (LxWxH)	kg
DRIVE 1500	829569	12	1500	USB A - QUICK CHARGE 5V/9V/12V	18	-	10	12000	17,5x7,5x3,0	0,6
DRIVE 1750 XC	829574	12	1500	USB A - QUICK CHARGE 5V/9V/12V	18	10	-	12000	17,5x7,5x3,0	0,7
				USB C - POWER DELIVERY 5V/9V/12V/15V/20V	60					

EN/ 12V multifunction lithium starters. Powerbank with USB C output with Power Delivery (mod. 1750), USB A output (Quick Charge), wireless recharge (mod. 1750) and 12V output (mod.1500). Powerful light source with 2 high intensity led lights and 4 operating modes. LED visualization of the charge status. Complete with starting cables, connecting cable and cigarette lighter plug with 2 USB sockets.

FR/ Démarreurs multifonctions au lithium 12V. Powerbank avec sortie USB C avec Power Delivery (mod. 1750), sortie USB A (Charge rapide), recharge sans fil (mod. 1750) et sortie 12V (mod.1500). Source lumineuse puissante avec 2 lampes led à haute intensité et 4 modes de fonctionnement. Affichage du niveau de charge par led. Complet avec câbles de démarrage, câble de connexion et prise allume-cigare avec 2 prises USB.

DE/ 12-V-Lithium-Multifunktionsstarter. Powerbank mit USB-C-Ausgang mit Power Delivery (Mod. 1750), USB-A-Ausgang (Quick Charge), kabelloses Laden (Mod. 1750) und 12V-Ausgang (Mod.1500). Leistungsstarke Lichtquelle mit 2 hochintensiven LED-Leuchten und 4 Betriebsmodi. LED-Anzeige des Ladezustands. Komplett mit Starterkabeln, Anschlusskabel und Zigarettenanzünderstecker mit 2 USB-Buchsen.

IT/ Avviatori multifunzione al litio a 12V. Powerbank con uscita USB C con Power Delivery (mod. 1750), uscita USB A (Quick Charge), ricarica wireless (mod. 1750) e uscita a 12V (mod.1500). Potente fonte di illuminazione con 2 luci led ad alta intensità e 4 modalità di funzionamento. Visualizzazione a led del livello di carica. Completati di cavi di avviamento, cavo di collegamento e spina accendisigari con 2 prese USB.

ES/ Arrancadores multifunción de litio de 12V. Powerbank con salida USB C con Power Delivery (mod. 1750), salida USB A (Carga rápida), carga inalámbrica (mod. 1750) y salida de 12V (mod.1500). Potente fuente de luz con 2 luces led de alta intensidad y 4 modos de funcionamiento. Pantalla LED del nivel de carga. Completo con cables de arranque, cable de conexión y enchufe para encendedor de cigarrillos con 2 tomas USB.

PT/ Arrancadores multifunções de lítio de 12V. Powerbank com saída USB C com Power Delivery (mod. 1750), saída USB A (Carregamento rápido), carregamento sem fios (mod. 1750) e saída de 12V (mod.1500). Fonte de luz potente com 2 luzes led de alta intensidade e 4 modos de funcionamento. Indicação led do nível de carga. Completo com cabos de arranque, cabo de ligação e ficha de isqueiro com 2 tomadas USB.

DRIVE PRO 12 - DRIVE PRO 12/24

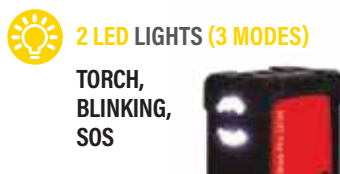

TECHNICAL DATA

CE EAC	CODE	V _{PH} V (50-60Hz)	mAh	V	A _{OUT} A	A _{START MAX} A	USB	A _{USB OUT} A	LxWxH cm	kg
DRIVE PRO 12	829572	100 - 240 1ph	12000	12	600	2000	2	1/2,1	21 x 12 x 7	1,1
DRIVE PRO 12/24	829573	100 - 240 1ph	24000	12 / 24	650	2200	2	1/2,1	21 x 12 x 7	1,5

STANDARD

JUMP STARTER CABLE 125182	POWER SUPPLY 169953	PLUG FOR CIGAR-LIGHTER

EN/ Multifunction 12V (mod. 12V) and 12V/24V (mod.12V/24V) lithium starters. Equipped with: two USB outputs (1A-2,1A) to charge (power bank) electronic devices (tablets, smartphones, etc.), high intensity LED lights with three function modes for fixed or emergency lighting. They use high-efficiency LiPO lithium polymer cells that provide rapid and complete charging, constantly monitored by a series of LEDs. Compact and strong they are designed for the professional use. Complete with starting cables, cigarette lighter plug and wall charge.

IT/ Avviatori multifunzione al litio a 12V (mod. 12V) e 12V/24V (mod.12V/24V). Dotati di: due uscite USB (1A- 2,1A) per la carica (power bank) di dispositivi elettronici (tablet, smartphone, etc), luci led ad alta intensità con tre modalità di funzionamento per illuminazione fissa o di emergenza. Utilizzano celle a polimeri di litio LiPO ad alta efficienza che consentono una ricarica completa e veloce, monitorata da una serie di led. Compatti e robusti sono pensati per l'uso professionale. Completati di cavi di avviamento, spina accendisigari e alimentatore di rete.

FR/ Démarreurs multifonction au lithium à 12V (mod. 12V) et 12V/24V (mod.12V/24V). Équipés de: deux sorties USB (1A-2,1A) pour la charge (banque de puissance) de dispositifs électroniques (tablettes, smartphones, etc), deux lampes à LED à haute intensité avec trois modalités de fonctionnement pour l'illumination fixe ou d'urgence. Ils utilisent des cellules à polymères de lithium LiPO à efficacité élevée qui permettent une recharge complète et rapide, surveillée par une série de LED. Compacts et robustes, ils sont conçus pour un usage professionnel. Fournis avec câbles de démarrage, fiche allume-cigares et alimentateur de réseau.

ES/ Arrancadores multifunción al litio de 12V (mod. 12V) y 12V/24V (mod.12V/24V). Dotados de: dos salidas USB (1A-2,1A) para la carga (power bank) de dispositivos electrónicos (tabletas, teléfonos inteligentes, etc), dos lámparas led de alta intensidad con tres modalidades de funcionamiento para iluminación fija o de emergencia. Utilizan celdas de polímeros de litio LiPO de alta eficiencia que permiten una recarga completa rápida, monitoreada por una serie de led. Compactos y robustos están diseñados para uso profesional. Completos con cables de arranque, enchufe encendedor de cigarrillos y alimentador de red.

DE/ 12V (mod. 12V) und 12V/24V (mod.12V/24V)-Lithium-Multifunktionsstarter. Lieferumfang: Zwei USB-Ausgänge (1A - 2,1A) zum Aufladen (Power Bank) elektronischer Geräte (Tablets, Smartphones, usw.), zwei starke LED-Leuchten mit drei Funktionen für Dauer- oder Notbeleuchtung. Es kommen hoch effiziente Lithiumpolymerzellen (LiPo) zum Einsatz, die einen kompletten, zügig ablaufenden Aufladevorgang gewährleisten, der sich anhand einer Reihe von LEDs überwachen lässt. Kompakt und robust sind für den professionellen Einsatz konzipiert. Ausgestattet mit Startkabeln, Stecker für den Zigarettenanzünder und Netzspeisegerät.

PT/ Arrancadores de lítio multifunções 12V (mod. 12V) e 12V/24V (mod.12V/24V). Equipados com: duas entradas USB (1A-2,1A) para carregar (power bank) dispositivos eletrônicos (tablets, smartphones, etc.), luzes LED de alta intensidade com três modos de funcionamento, para iluminação fixa ou de emergência. Utilizam células de polímero lítio LiPO de alta eficiência para uma recarga completa e rápida, constantemente monitorizada por uma série de LEDs. Compactos e robustos, são concebidos para utilização profissional. Fornecidos com cabos de arranque, adaptador para isqueiro e alimentador de rede.

MMA WELDING

MIG-MAG WELDING

TIG WELDING

PLASMA CUTTING

SPOT WELDING

CHARGING & STARTING

INDEX

STARTZILLA 4012 XT - STARTZILLA 9012 XT



STARTZILLA XT
THE S.O.SOLVER



MORE INFO



12V

TECHNICAL DATA

CE EAC	CODE	V _{PH} V (50-60Hz)	mAh	V	A _{START MAX} A	Ah	IP	LxWxH cm	kg
STARTZILLA 4012 XT	829527	100 - 240 1ph	15600	12	4000	100	IP43	15,5 x 23,4 x 31,8	3,4
STARTZILLA 9012 XT	829526	100 - 240 1ph	31200	12	9000	140	IP43	15,5 x 23,4 x 31,8	4,0

STANDARD

POWER SUPPLY
169999



OPTIONAL

FUSE
200A - 121818



EN/ Multifunction electronic starters, power supply and testers, with LiFePO4 lithium batteries for 12V (mod. 4012 - 9012) and 12V/24V (mod. 9024 - 12024) starting of cars, vans, small boats, lorries etc. Features: OVER RIDE function for starting in emergency conditions with missing (or completely discharged) battery • SUPPLY function for stable power supply during battery change • TEST function for battery, start-up and alternator • high intensity led lamp • robust and compact • Protection against: polarity reversal, short-circuit, overvoltage (incompatible battery voltage), undervoltage (cut-off voltage), overcurrent, overheating, under-temperature, accidental contacts. Complete with starting cables and wall charge.

IT/ Avviatori, alimentatori e tester elettronici multifunzione con batteria al Litio LiFePO4 per l'avviamento a 12V (mod. 4012 - 9012) e 12V/24V (mod. 9024 - 12024) di auto, furgoni, piccole imbarcazioni, camion, etc. Caratteristiche: funzione OVER RIDE per avviamenti in condizioni di emergenza con batteria mancante (o completamente scarica) • funzione SUPPLY per l'alimentazione stabile durante i cambi batteria • funzione TEST batteria, avviamento e alternatore • luce led ad alta intensità • robusti e compatti • protezione contro inversione polarità, corto circuito, sovratensione (tensione batteria incompatibile), sottotensione (tensione di cut-off), sovraccorrente, surriscaldamento, sottotemperatura, contatti accidentali, correnti di ritorno dell'alternatore. Completi di cavi di avviamento e alimentatore di rete.

FR/ Démarreurs, alimentateurs et testeurs électroniques multifonction, avec batteries au Lithium LiFePO4 pour le démarrage en 12V (mod. 4012 - 9012) et 12V/24V (mod. 9024 - 12024) d'autos, fourgons, petites embarcations, camions, etc. Caractéristiques: Fonction OVER RIDE pour démarrer en situation d'urgence avec batterie manquante (ou complètement déchargée) • Fonction SUPPLY pour l'alimentation stable durant les changements de batterie • Fonction TEST batterie, démarrage et alternateur • lampe à LED à haute intensité • robustes et compacts • protections contre : inversion de polarités, court-circuit, surtension (tension batterie incompatible), sous-tension (tension de coupure), surintensité, surchauffe, sous-température, contacts accidentels. Fournis avec câbles de démarrage et alimentateur de réseau.

STARTZILLA 9024 XT - STARTZILLA 12024 XT



STARTZILLA XT
THE S.O.SOLVER

NEW



MMA WELDING
MIG-MAG WELDING
TIG WELDING
PLASMA CUTTING
SPOT WELDING
CHARGING & STARTING
INDEX



12V 24V

TECHNICAL DATA

CE EAC	CODE	V _{PH} V (50-60Hz)	mAh	V _{BATT} V	A _{START MAX} A	Ah	IP	LxWxH cm	kg
STARTZILLA 9024 XT	829525	100 - 240 1ph	31200	12 / 24	9000 (12V) 4500 (24V)	140(12V) 120(24V)	IP43	15,5 x 23,4 x 31,8	4,3
STARTZILLA 12024 XT	829528	100 - 240 1ph	40000	12 / 24	12000 (12V) 6000 (24V)	225(12V) 200(24V)	IP43	15,5 x 23,4 x 31,8	4,6

STANDARD

POWER SUPPLY
169999

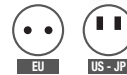

OPTIONAL

FUSE
200A mod. 9024 XT
121818

500A mod. 12024 XT
122093



ES/ Arrancadores, fuentes de alimentación y probadores electrónicos multifunción, con baterías al litio LiFeP04 para el arranque a 12V (mod. 4012 - 9012) a 12V/24V (mod. 9024 - 12024) de coches, furgonetas, embarcaciones pequeñas, camiones, etc. Características: Función OVER RIDE para arrancar en condiciones de emergencia con batería faltante (o completamente descargada) • Función SUPPLY para alimentación estable durante los cambios de batería • Función TEST de batería, arranque y alternador • lámpara led de alta intensidad • robustos y compactos • protecciones contra: inversión de polaridad, cortocircuito, sobretensión (tensión de batería incompatible), tensión baja (tensión de cut-off), subidas de corriente, sobrecalentamiento, temperatura baja, contactos accidentales. Equipados con cables de arranque y alimentador de red.

DE/ Starter, Stromversorgungen sowie elektronische Multifunktionsstester mit Lithiumbatterien LiFeP04 zum Starten bei 12V (mod. 4012 - 9012) und 12V/24V (mod. 9024 - 12024) beispielsweise von Autos, Lieferwagen, kleinen Booten, Lkws usw. Eigenschaften: OVER RIDE-Funktion zum Starten in Notfällen mit fehlender (oder vollständig entladener) Batterie • SUPPLY-Funktion zur konstanten Stromversorgung während der Batteriewechsel • TEST-Funktion zum Testen von Batterien, Startleistung und Drehstromlichtmaschine • starke LED-Leuchte • robust und kompakt • Schutzeinrichtungen gegen Verpolung, Kurzschluss, Überspannung (Batteriespannung inkompatibel), Unterspannung (Grenzspannung), Überstrom, Überhitzung, Untertemperatur sowie unbeabsichtigte Kontakte. Ausgestattet mit Starterkabel und Netzspeisegerät.

PT/ Arrancadores, fontes de alimentação e aparelhos de teste electrónicos multifunções com bateria de lítio LiFeP04 para arranque 12V (mod. 4012 - 9012) e 12V/24V (mod. 9024 - 12024) de carros, carrinhas, botes, camiões, etc. Características: função OVER RIDE para arrancar em condições de emergência sem bateria (ou completamente descarregada) • função SUPPLY para alimentação estável durante as trocas de bateria • função TESTE de bateria, arranque e alternador • luz LED de alta intensidade • robustos e compactos • proteções contra: inversão de polaridade, curto-circuito, sobretensão (tensão incompatível da bateria), subvoltagem (voltagem de suspensão), picos de corrente, sobreaquecimento, baixa temperatura, contactos acidentais, correntes de retorno do alternador. Completos com cabos de arranque e fonte de alimentação.



TECHNICAL DATA

CE EAC	CODE	V _{PH} V (50-60Hz)	V _{START} V	A _h Ah	A _{OUT} A	A _{START MAX} A	LxWxH cm	kg
PRO START 2824	829517	230 1ph	12 / 24	44 / 22	800	2500	20,5 x 33,5 x 36	15,2

STANDARD

POWER SUPPLY
169692



EN/ Battery-powered starter suitable for 12V/24V starting of cars, vans, boats, agricultural vehicles, power sources etc. When connected to the cigar-lighter outlet it maintains the voltage on all circuits during battery changes and is also a 12V power source for use in emergencies. Fit with a safety switch for starting, it does not damage the electronics of the vehicle and allows for a large number of starting operations before being recharged. PRO START 2824 can be recharged using the special power supply, connected to the mains network, or using the cigar-lighter outlet of the vehicle (for the safeguard of the battery, charge for 12 hours before use, charge again after each use and every 3 months in any case).

IT/ Avvitatore portatile a batteria, adatto all'avviamento a 12V/24V di auto, furgoni, camion, imbarcazioni, mezzi agricoli, generatori, etc. Collegato alla presa accendisigari del mezzo, mantiene sotto tensione tutti i circuiti nei cambi batteria; è altresì una fonte di energia a 12V in casi di emergenza. Fornito di un interruttore di sicurezza per l'avviamento, non danneggia l'elettronica del veicolo e consente di effettuare numerose operazioni di avviamento prima della conseguente ricarica. È possibile ricaricare PROSTART 2824 attraverso l'apposito alimentatore, collegato alla tensione di rete, oppure attraverso la presa accendisigari del mezzo (per salvaguardare l'integrità della batteria, caricare per 12 ore prima dell'uso, dopo ogni uso e comunque ogni 3 mesi).

FR/ Démarreur avec batterie, pour le démarrage à 12V/24V de d' automobiles, fourgons, embarcations, véhicules agricoles, générateurs etc. Branché à l'allume-cigares du véhicule, il maintient tous les circuits sous tension lors le changement de la batterie et il est aussi une source d'énergie à 12V en cas d'urgence. Fourni d'un interrupteur de sécurité pour le démarrage, n'endommage pas l'électronique du véhicule et permet d'effectuer de nombreuses opérations de démarrage avant la recharge conséquente. PRO START 2824 peut être rechargé à l'aide de l'alimentation prévue, branché à la tension de secteur, ou à l'allume-cigares du véhicule, (pour préserver le parfait fonctionnement de la batterie, charger cette dernière durant 12 heures avant l'utilisation, ainsi qu'après chaque utilisation et tous les 3 mois).

ES/ Arrancador de batería, adecuado para el arranque a 12V/24V de coches, furgones, embarcaciones, autovehículos agrícolas, generadores, etc. Conectado a la toma del encendedor de cigarrillos del medio mantiene bajo tensión todos los circuitos en los cambios de batería del vehículo; además es una fuente de energía de 12V en casos de emergencia. Dotado de un interruptor de seguridad por el arranque, no daña la electrónica del vehículo y permite efectuar numerosas operaciones de arranque antes de la consiguiente recarga. Es posible recargar PRO START 2824 a través del relativo alimentador, conectado a la tensión de red, o a través de la toma del encendedor de cigarrillos del medio, (para proteger la integridad de la batería, cargar durante 12 horas antes del uso, después de cada uso y cada 3 meses).

DE/ Batteriebetriebene Starter mit 12V/24V Spannung zum Starten von Autos, Lieferwagen, Booten, Landwagen, Generatoren, usw. Angeschlossen an die Buchse des Zigarettenanzünders im Fahrzeug hält es während des Batteriewechsels alle Stromkreise unter Spannung, es steht auch als 12V-Energiequelle in Notfällen zur Verfügung. Komplett mit einem Sicherheitsschalter zum Starten, beschädigt es die Elektronik des Wagens nicht und ermöglicht mehrere Startvorgänge bevor es wieder aufgeladen ist. PRO START 2824 läßt sich aufladen mit dem zugehörigen, an das Stromnetz angeschlossenen Speisegerät oder verbunden mit der Steckerbuchse des Zigarettenanzünders, (um die einwandfreie Funktionsfähigkeit der Batterie zu gewährleisten, laden Sie 12 Stunden vor dem Gebrauch, nach jedem Gebrauch und spätestens alle 3 Monate).

PT/ Arrancador a bateria para automóveis, camionetas, embarcações, veículos agrícolas, geradores, etc. a 12V/24V. Quando ligado ao isqueiro mantém a voltagem em todos os circuitos durante operações de troca de bateria e funciona também como fonte de alimentação em caso de emergência. Equipado com um interruptor de segurança para o arranque, não danifica os dispositivos eletrônicos do veículo e permite um vasto número de operações antes de ser recarregado. O PRO START 2824 pode ser recarregado através de uma fonte de alimentação especial ligada à rede, ou através do isqueiro do veículo (para salvaguarda da bateria, carregar durante 12 horas antes da primeira utilização, carregar novamente após cada utilização e sempre a cada 3 meses).

START PLUS 4824 - START PLUS 6824



TELWIN



12V 24V

TECHNICAL DATA

CE EAC	CODE	V _{PH} V (50-60Hz)	START V	A _h Ah	A _{OUT} A	A _{START MAX} A	START Ah	LxWxH cm	kg
START PLUS 4824	829570	230 1ph	12 / 24	40 (12V) 20 (24V)	1600 (12V) 800 (24V)	4400 (12V) 2200 (24V)	200 (12V) 150 (24V)	30,5 x 36 x 63	30
START PLUS 6824	829571	230 1ph	12 / 24	80 (12V) 40 (24V)	2000 (12V) 1000 (24V)	6000 (12V) 3000 (24V)	225 (12V) 200 (24V)	30,5 x 36 x 63	41

STANDARD

QUICK CHARGE
T-CHARGE 12
pag. 63



EN/ Battery-powered starters suitable for 24V starting of trucks, vans, tractors and 12V starting of cars, vans, boats, power sources, etc. The 12V output is a power source for use in emergencies; when connected to the cigar-lighter outlet it maintains the voltage on all circuits during battery changes of vehicles with 12V batteries. They do not damage the electronics of the vehicle and allow for a large number of starting operations before being recharged. Start Plus can be recharged* using the battery charger included. Complete with booster cables.

IT/ Avviatori a batteria, adatti all'avviamento a 24V di autocarri, camion, trattori, ruspe e a 12V di auto, furgoni, imbarcazioni, generatori, etc. L'uscita a 12V è una fonte di energia nei casi di emergenza; collegata alla presa accendisigari del mezzo, mantiene sotto tensione tutti i circuiti nei cambi batteria dei veicoli con batterie a 12V. Non danneggiano l'elettronica del veicolo e consentono di effettuare numerose operazioni di avviamento prima della conseguente ricarica. E' possibile ricaricare* Start Plus attraverso il caricabatterie incluso. Completati di cavi di avviamento.

FR/ Démarreurs avec batterie, pour le démarrage à 24V de camions, tracteurs, fourgons e t à 12V d'automobiles, fourgons, camions, embarcations, générateurs, etc. Le sortie à 12V est une source d'énergie en cas d'urgence; branché à la prise de l'allume-cigares du véhicule, il maintient tous les circuits sous tension lors le changement de la batterie du véhicule avec batterie à 12V. N'endommagent pas l'électronique du véhicule et permet d'effectuer de nombreuses opérations de démarrage avant la recharge conséquente. Start Plus peut être rechargée* à l'aide de le chargeur inclus. Fournis avec câbles de démarrage.

ES/ Arrancadores con batería, adecuados para el arranque a 24V de camiones, tractores y carros y a 12V de coches, camiones, embarcaciones, generadores, etc. La salida de 12V es una fuente de energía en casos de emergencia; conectada a la toma del encendedor de cigarrillos del medio, mantiene bajo tensión todos los circuitos en los cambios de batería del vehículo con batería de 12V. No dañan la electrónica del vehículo y permiten efectuar numerosas operaciones de arranque antes de la consiguiente recarga. Es posible recargar* Start Plus a través del cargador incluido. Equipados con cables de arranque.

DE/ Batteriebetriebene Starter mit 24V Spannung zum Starten von LKW, Wagen, Traktors und 12V Spannung zum Starten von Autos, Lieferwagen, Booten, Generatoren, usw. Die 12V Ausgang steht als 12V-Energiequelle auch in Notfällen zur Verfügung, angeschlossen an die Buchse des Zigarettenanzünders im Fahrzeug hält es während des Batteriewechsels (wo ein 12V Batterie gibt) alle Stromkreise unter Spannung. Diese Starter beschädigen die Elektronik des Wagens nicht und ermöglichen mehrere Startvorgänge bevor sie wieder aufgeladen sind. Start Plus läßt sich aufladen* durch das Batterieladegerät enthalten. Komplett mit Starten kabel.

PT/ Arrancadores a bateria para camiões, autocarros e tratores a 24V e para automóveis, camionetas, embarcações, geradores, etc. a 12V. A saída de 12V serve como fonte de alimentação para emergências; quando ligada ao isqueiro mantém a voltagem em todos os circuitos durante operações de troca de bateria em veículos com baterias de 12V. Não danificam os componentes eletrônicos do veículo e permitem um vasto número de operações antes de serem recarregados. O Start Plus pode ser recarregado* utilizando o carregador de baterias incluído. Fornecido com cabos de arranque.

(*) For the safeguard of the battery, charge for 12 hours before use, charge again after each use and every 3 months in any case - Per salvaguardare l'integrità della batteria caricare per 12 ore prima dell'uso, dopo ogni uso e comunque ogni 3 mesi - Pour préserver le parfait fonctionnement de la batterie, charger cette dernière durant 12 heures avant l'utilisation, ainsi qu'après chaque utilisation et tous les 3 mois - Para proteger la integridad de la batería, cargar durante 12 horas antes del uso, después de cada uso y cada 3 meses - Um die einwandfreie Funktionsfähigkeit der Batterie zu gewährleisten, laden Sie 12 Stunden vor dem Gebrauch, nach jedem Gebrauch und spätestens alle 3 Monate - Para salvaguarda da bateria, carregar durante 12 horas antes da primeira utilização, carregar novamente após cada utilização e sempre a cada três meses.

MMA WELDING

MIG-MAG WELDING

TIG WELDING

PLASMA CUTTING

SPOT WELDING

CHARGING & STARTING

INDEX

BATTERY TESTERS



PROFESSIONAL

DTP 900 BATTERY TESTER

WITH
PRINTER

INCLUDED

1PC
982490



DTP 790 BATTERY TESTER

WITH
PRINTER

INCLUDED

2PCS
982491



	CODE	START	A _h	TEST				GRAPHIC	DIGITAL	LxWxH mm (LxWxH)	kg
				BATTERY CHARGE	ALTERNATOR CIRCUIT	START SYSTEM	BATTERY START CAPABILITY (CCA)				
DTP 900 Battery Tester with Printer	804244	12/24	4 - 250	■	■	■		■	98x78x275	0,7	
DTP 790 Battery Tester with Printer	804245	12	4 - 250	■	■	■	■	■	98x78x275	0,7	
STS 700 Battery Tester	804243	12	8 - 240	■	■	■	■		80x24x150	0,3	
STS 600 Battery Tester	804242	12	8 - 240	■	■	■	■		80x24x150	0,3	
DT400 Digital Battery Tester	802605	12	20 - 200	■			■	■	78x22x145	0,2	

BATTERY TESTERS



PROFESSIONAL

STS 700 BATTERY TESTER



DOWNLOAD SOFTWARE

REPORTS PRINTING*

REPORTS SAVING

GRAPHICAL VOLTAGE DISPLAY



STS 600 BATTERY TESTER



DOWNLOAD SOFTWARE

REPORTS PRINTING*



INTERNATIONAL STANDARDS



* REPORTS PRINTING

Software available for printing - software disponibile per la stampa - software disponible pour l'impression - software disponible para imprimir - software zum drucken verfügbar - software disponível para impressão

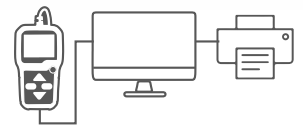

SEMI-PRO

DT400 DIGITAL BATTERY TESTER



ARC PROTECTOR

EN/ Provides surge protection (voltage peaks - welding arcs) for the on-board electronics during maintenance interventions when connected to the vehicle battery.

IT/ Collegato alla batteria del veicolo, fornisce protezione da sovratensioni (picchi di tensione - archi di saldatura) all'elettronica di bordo, durante gli interventi di manutenzione.

FR/ Branché à la batterie du véhicule, il fournit une protection contre les surtensions (pics de tension- arcs de soudage) à l'électronique de bord durant les interventions d'entretien.

ES/ Conectado a la batería del vehículo, protege contra las sobretensiones (picos de tensión - arcos de soldadura) en los dispositivos electrónicos de bordo durante las intervenciones de mantenimiento.

DE/ Bietet bei Anschluss an die Fahrzeugbatterie Überspannungsschutz (Spannungsspitzen - Schweißbögen) für die Bordelektronik bei Wartungsarbeiten.

PT/ Proteção contra picos (de corrente - arcos de soldadura) para dispositivos eletrónicos de bordo durante operações de manutenção quando ligado à bateria do veículo.

802840

12V



MMA WELDING

MIG-MAG WELDING

TIG WELDING

PLASMA CUTTING

SPOT WELDING

CHARGING & STARTING

INDEX

WELDING HELMETS



T-VIEW 180

DIN 3/4+8/8÷12
SENSITIVITY AND DELAY EXTERNAL CONTROL

- Regolazione esterna sensibilità e ritardo
- Réglage externe de sensibilité et de retard
- Regulación externa de sensibilidad y de retraso
- Externe Einstellung der Empfindlichkeit und Verzögerung
- Ajuste da sensibilidade externa e retardamento

> 2A
TIG WELDING

- Saldatura tig
- Soudage tig
- Soldadura tig
- Wig-Schweißen
- Soldadura Tig

0,1ms
QUICK AUTODARKENING FILTER

- Vetro autoscurante veloce
- Vitre auto-obscurcissante rapide
- Vidrio de oscurecimiento automático rápido
- Glas mit beschleunigter Selbstverdunkelung
- Vidro de escurecimento automático rápido

4 SENSORS

- Sensori
- Détecteurs
- Sensores
- Sensoren
- Sensores

EXTENDED THROAT GUARD FOR PROTECTION

- Protezione estesa salva-gola
- Protection prolongée sauve gorge
- Protector de garganta extendido para protección
- Erweiterter Kehlschutz
- Protecção alargada da garganta



180° 180° VIEWING AREA

• Area di visione 180°

• Aire de vision 180°

• área de visión 180°

• 180°-Sichtfeld

• Área de visualização de 180°

TRUE COLOR TECHNOLOGY.
IT ALLOWS THE REALISTIC COLOR PERCEPTION

Tecnologia true color. Permette una percezione realistica dei colori

Technologie true color. Elle garantie des couleurs réelles

Tecnologia true color. Permite la percepción realista de los colores

True-color-Technologie. Es ermöglicht die realistische Farbwahrnehmung

Tecnologia de true color. Permite uma visão realista das cores

GRINDING MODE

- Modalità smerigliatura
- Modalité meulage
- Modalidad esmerilado
- Schleifmodus
- Modo de rebarbar

GLASS PROTECTION

6
PCS

B

EXTERNAL

390 x 150 mm mod. T-View 180 - 804103

396 x 116 mm mod. Roundview - 804395

INTERNAL

89 x 113 mm mod. T-View 180 - 804104

70 x 10,5 mm mod. Roundview - 804396

SIDE FILTER (2PCS)

86x78-46 mm mod. Roundview - 804399

MAGNIFYING LENS

+	1,5x 804406	2,0x 804407	2,5x 804408
----------	----------------	----------------	----------------

DOUBLE RANGE

4÷8 8÷12

SHADE RANGE

DIN 3/4+8

PLASMA CUTTING
OXY ACETYLENE CUTTING

DIN 3/8+12

MIG/MAG - TIG - MMA

SHADE CONTROL WITH TRUE COLOR TECHNOLOGY

SHADE 4

SHADE 12

- Darkening adjustment
- Regolazione del grado di oscuramento
- Obscurcissement réglable
- Ajuste oscurecimiento
- Verdunkelung Einstellung
- Ajuste do grau de escurecimento

T-VIEW 180

804097



YEARS WARRANTY
2

TECHNICAL DATA

2
PCS

- automatic
- variable: 3/4+8/8÷12 DIN
- double range
- grinding mode
- TIG from >2A
- class: 1/1/1/1
- 4 sensors
- 180° view area
- true color

ROUNDVIEW

804392



YEARS WARRANTY
2

TECHNICAL DATA

2
PCS

- automatic
- variable: 3/5+9/9÷13 DIN
- double range
- grinding mode
- TIG from >2A
- class: 1/1/1/1
- 4 sensors
- 180° view area
- true color

WELDING HELMETS



TELWIN

VANTAGE

DIN 5÷9/9÷13
EXTERNAL CONTROL

- Regolazione esterna
- Réglage externe
- Regulación exterior
- Externe Regulierung
- Regulação externa

> 2A
TIG WELDING

- Saldatura tig • Soudage tig
- Soldadura tig • Wig-Schweissen
- Soldadura Tig

0,1ms
QUICK AUTODARKENING FILTER

- Vetro autoscurante veloce
- Vitre auto-obscurecissante rapide
- Vidrio de oscurecimiento automático rápido • Glas mit beschleunigter Selbstverdunkelung • Vidro de Escurecimento automático rápido

4 SENSORS

- Sensori • Détecteurs • Sensores
- Sensoren • Sensores



TRUE COLOR TECHNOLOGY.
IT ALLOWS THE REALISTIC
COLOR PERCEPTION

- Tecnologia true color. Permette una percezione realistica dei colori
- Technologie true color. Elle garantie des couleurs réelles
- Tecnología true color. Permite la percepción realista de los colores
- True-color-Technologie. Es ermöglicht die realistische Farbwahrnehmung
- Tecnologia de true color. Permite una visão realista das cores

GRINDING MODE

- Modalità smerigliatura • Modalité ponçage • Modalidad esmerilado • Schleifmodus • Modo de rebarbar

GLASS PROTECTION

6 **B**

EXTERNAL
114x134 mm
802939

INTERNAL
96x104 mm - 802951
mod. Vantage Grey XXL
69,5x103,5 mm - 802949
mod. Vantage Red XL

MAGNIFYING LENS

	1,5x 804406	2,0x 804407	2,5x 804408
--	----------------	----------------	----------------

DOUBLE RANGE

5÷9 9÷13

SHADE RANGE

DIN 4/5÷9

PLASMA CUTTING
OXY ACETYLENE CUTTING

DIN 4/9÷13

MIG/MAG - TIG - MMA

SHADE CONTROL WITH TRUE COLOR TECHNOLOGY

SHADE 5

SHADE 13

- Darkening adjustment
- Regolazione del grado di oscuramento
- Obscurissement réglable
- Ajuste oscurecimiento
- Verdunkelung Einstellung
- Ajuste do grau de escurecimento

VANTAGE GREY XXL

802937



2
YEARS WARRANTY

TECHNICAL DATA

- automatic
- variable: 4/5÷9/9÷13 DIN
- double range
- grinding mode
- TIG from >2A
- class: 1/1/1/2
- 4 sensors
- XXL view area
- true color

VANTAGE RED XL

802936



2
YEARS WARRANTY

TECHNICAL DATA

- automatic
- variable: 4/5÷9/9÷13 DIN
- double range
- grinding mode
- TIG from >2A
- class: 1/1/1/2
- 4 sensors
- XL view area
- true color

WELDING HELMETS



EYETRON

804262

DIN 5÷9/9÷13
SENSITIVITY AND DELAY EXTERNAL CONTROL

• Regolazione esterna sensibilità e ritardo • Réglage externe de sensibilité et de retard • Regulación externa de sensibilidad y de retraso • Externe Einstellung der Empfindlichkeit und Verzögerung • Ajuste da sensibilidade externa e retardamento

> 2A TIG WELDING

TECHNICAL DATA

2 PCS

- automatic
- variable: 5÷9/9÷13 DIN
- double range
- grinding mode
- TIG from >2A
- class: 1/1/1
- 4 sensors
- XL view area
- true color

YEARS WARRANTY
2



TRUE COLOR TECHNOLOGY. IT ALLOWS THE REALISTIC COLOR PERCEPTION

• Permette una percezione realistica dei colori • Elle garantit des couleurs réelles • Permite la percepción realista de los colores • Es ermöglicht die realistische Farbwahrnehmung • Permite uma visão realista das cores

0,1ms

QUICK AUTODARKENING FILTER

• Vetro autoscurante veloce • Vitre auto-obscurecissante rapide • Vidrio de oscurecimiento automático rápido • Glas mit beschleunigter Selbstverdunkelung • Vidro de escurecimento automático rápido



GRINDING MODE

4 SENSORS

JAGUAR CYBORG

804081

DIN 5÷9/9÷13
EXTERNAL CONTROL

• Regolazione esterna • Réglage externe • Regulación exterior • Externe Regulierung • Regulação externa

TECHNICAL DATA

2 PCS

- automatic
- variable: 4/5÷9/9÷13 DIN
- double range
- grinding mode
- TIG from >5A
- class: 1/1/1/2
- 4 sensors

YEARS WARRANTY
2



0,4ms

QUICK AUTODARKENING FILTER

• Vetro autoscurante veloce • Vitre auto-obscurecissante rapide • Vidrio de oscurecimiento automático rápido • Glas mit beschleunigter Selbstverdunkelung • Vidro de escurecimento automático rápido



GRINDING MODE

> 5A TIG WELDING

2 SENSORS



STREAM FLAME

804235

STREAM ROBOT

804234

TECHNICAL DATA

2 PCS

- automatic
- variable: 4/9÷13 DIN
- grinding mode
- TIG from >5A
- class: 1/1/1/2

GLASS PROTECTION

6 PCS



EXTERNAL

122x139 mm
mod. Eyetron - 804409

114x134 mm
mod. Jaguar - 802939

95x115,5 mm
mod. Stream - 804312

INTERNAL

71,7x105,7 mm
mod. Eyetron - 804410

50x95 mm
mod. Jaguar - 804101

47x100 mm
mod. Stream - 804313

MAGNIFYING LENS



1,5x
804406

2,0x
804407

2,5x
804408

	MMA MIG-MAG TIG	TIG	AUTOMATIC	GRINDING MODE	VIEWING AREA (mm)	VARIABLE (*) DIN	SENSITIVITY	DELAY (s)	DIN	LENS SPEED (ms)	SENSORS	OPTICAL CLASS
EYETRON 804262	✓	>2A	✓	✓	100X60	- 4/5÷9/9÷13 DOUBLE RANGE +	- 0,1 +	0,1 ÷ 0,8	4	< 0,1	4	1/1/1/1
JAGUAR CYBORG 804081	✓	>5A	✓	✓	92X42	- 4/5÷9/9÷13 DOUBLE RANGE +	- 0,1 +	0,1 ÷ 1	4	0,4	2	1/1/1/2
JAGUAR 804082	✓	>5A	✓	✓	92X42	- 4/5÷9/9÷13 DOUBLE RANGE +	- 0,1 +	0,1 ÷ 1	4	0,4	2	1/1/1/2
STREAM FLAME 804235	✓	>5A	✓	✓	93X43	- 4/9÷13 +	- 0,2 +	0,2 ÷ 0,9	4	0,3	2	1/1/1/2
STREAM ROBOT 804234	✓	>5A	✓	✓	93X43	- 4/9÷13 +	- 0,2 +	0,2 ÷ 0,9	4	0,3	2	1/1/1/2

GLOVES

PROFESSIONAL WELDING GLOVES • GUANTI PROFESSIONALI PER SALDATURA • GANTS DE SOUDAGE PROFESSIONNEL • GUANTES DE SOLDADURA PROFESIONAL • PROFESSIONELLE SCHWEISSHANDSCHUHE • LUVAS SOLDADURA PROFISSIONAIS

MONTANA

804336



6 PCS B

MONTANA PLUS

804337



6 PCS B

OREGON

804338



6 PCS B

SUGGESTED FOR TIG

DAKOTA

804339



6 PCS B

SUGGESTED FOR TIG

SCREENS

SCHERMI • ÉCRANS • PANTALLAS • SCHIRME • SEPARADORES DE PROTEÇÃO



Protective screen with support kit
 • Kit schermo protettivo con supporto
 • Kit support écran de protection avec support
 • Kit pantalla de protección con soporte
 • Schutzschirm-Kit mit Halterung
 • Kit separador de proteção com suporte

RED • rosso • rouge • rojo • rot • vermelho
 803508

GREEN • verde • vert • verde • grün • verde
 803509



Protective screen
 • schermo protettivo • écran de protection
 • pantalla de protección • Schutzschirm
 • Separador de proteção

1740x1740MM

RED • rosso • rouge • rojo • rot • vermelho
 802676

GREEN • verde • vert • verde • grün • verde
 802677

BLANKETS

COPERTE • COUVERTURES • MANTAS • SCHWEISSDECKEN • MANTAS DE PROTEÇÃO

Heat resistant blanket • Coperta anti-calore • Couverture anti-chaueur • Protector anti-calor • Hitzeschutzdecke • Manta anticolor



XL

UP TO 550°C

White • bianca • blanche • blanca • weiß • branco
 1950x2000mm
 804136



UP TO 1100°C

White • bianca • blanche • blanca • weiß • branco
 1500x1900mm
 802679



**ANTISTATIC
SOFT**

UP TO 1300°C

Black • nero • noir • negro • schwarz • preto
 1800x2000mm
 804135

DURANGO

WELDER'S APRON • GREMBIULE PER SALDATURA • TABLIER DE SOUDAGE • DELANTAL PARA SOLDADURA • SCHWEISSERSCHÜRZE • AVENTAL DE SOLDADURA

ONE SIZE 595x880mm

804369



HEAVY DUTY

Usò intensivo • usage intensif
 • uso intensivo • Strapazierfähig
 • utilização intensiva

HIGH QUALITY

Alta qualità • haute qualité • alta calidad
 • Qualitativ Hochwertig • alta qualidade



HEAT & SPARK RESISTANT

Resistente a calore & scintille • résistante à la chaleur et aux étincelles • resistente al calor y a las chispas • Hitze- & Funkenbeständig
 • Resistente ao calor e às faíscas



ADJUSTABLE STRAPS

Bretelle regolabili • bretelles réglables • tirantes ajustables • Einstellbare Träger • correias ajustáveis



FAST RELEASE BUCKLE

Fibbia a sgancio rapido • boucle rapide • hebilla de desenganche rápido • Schnellverschluss • fivela de abertura rápida



MULTI-SIZE POCKETS

Tasche multi-formato • poches multi-format • bolsillos multiformato • Taschen in verschiedenen Größen • bolsos multi-tamanho



ARAMID THREAD STITCHING

Cucitura in filo aramidico • coutures en fil aramide • costuras de hilo de aramida • Nähte aus Aramidgarn • costura de fio de aramida

BOOSTER CABLES



**BOOSTER CABLES - CAVI AVVIAMENTO - CABLES DE DEMARRAGE - CABLES DE ARRANQUE - STARTEN KABEL
CABOS DE ARRANQUE**

POWER LINE - DIY RANGE (CCA)



3 m Ø16 mm 250A 802746

3 m Ø25 mm 350A 802747



ELECTRONIC CONTROL

3 m Ø16 mm 250A 802698

EN/ With tester and protection. Indicates charge status, inverted polarity and active alternator.

IT/ Con tester e protezione. Segnala lo stato di carica, l'inversione di polarità e l'alternatore funzionante.

FR/ Avec tester et protection. Signale l'état de charge, l'inversion de polarité et l'alternateur en fonctionnement.

ES/ Con tester y protección. Marca el estado de carga, la inversión de polaridad y el alternador en funcionamiento.

DE/ Mit Tester und Schutz. Zeigt den Ladezustand, das Vertauschen der Polung und den Betrieb des Wechselstromgenerators an.

PT/ Com dispositivo de teste e proteção. Indica o estado da carga, inversão de polaridade e alternador em funcionamento.



PRO LINE - PROFESSIONAL RANGE



3 m Ø16 mm 350A 802515

3 m Ø25 mm 550A 802516

3 m Ø35 mm 800A 802668

AUTOMOTIVE WELDING CLAMPS

PINZE DI SALDATURA PER AUTOMOTIVE - PINCES DE SOUDAGE POUR AUTOMOTIVE - PINZAS DE SOLDADURA PARA AUTOMOTIVE - AUTOMOTIVE SCHWEISSZANGEN

802627

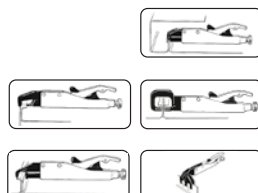

802586



MIG-MAG ACCESSOIRES



PRODUCTS		TECHNOMIG 180, TECHNOMIG 210 DUAL SYNERGIC	TECHNOMIG 215, TECHNOMIG 225	TECHNOMIG 223 TREO	TECHNOMIG 240, 260, ELECTROMIG 300 SYN. ELECTROMIG 230, 330 WAVE	TECHNOMIG 243 WAVE	ELECTROMIG 400 SYNERGIC
ACCESSORIES							
Torches - Torce - Torches - Sopletes - Brenner - Tochás		MT15 3 m □ 742180 4 m □ 742181	MT15 3 m □ 742180 4 m □ 742181 5 m □ 742182	MT15 3 m □ 742180 (RED) 3 m □ 742944 (BLUE) 4 m □ 742181 5 m □ 742182	MT25 3 m □ 742183 4 m □ 742184 5 m □ 742185	MT15 3 m □ 742180 (RED) 3 m □ 742944 (BLUE) MT25 ALU 3 m □ 742708 (GRAY)	MT36 3 m □ 742186 4 m □ 742187 5 m □ 742188
Contact Tips - Tubetti di contatto - Tubes contact - Tubitos de contacto - Kontaktröhrchen - Bicos pñio soldadura	 Steel	0,6 □ 722415 (-) 0,8 □ 722416 (-) 0,1 □ T.210 □ 722705	0,6 □ 722415 (-) 0,8 □ 722416 (-) 0,1 □ 722705	0,6 □ 722415 (-) 0,8 □ 722680 0,1 □ 722681 0,1,2 □ 722682 NO E.230	0,6 □ 722415 (-) 0,8 □ 722416 (-) 0,1 □ 722705	0,6 □ 722415 (-) 0,8 □ 722680 0,1 □ 722681 0,1,2 □ 722682 0,16 □ 722797	0,6 □ 722415 (-) 0,8 □ 722680 0,1 □ 722681 0,1,2 □ 722682 0,16 □ 722797
Contact Tips - Tubetti di contatto - Tubes contact - Tubitos de contacto - Kontaktröhrchen - Bicos pñio soldadura	 Al	0,8 □ 722556 (-) 0,1 □ 722552 (-)	0,8 □ 722556 (-) 0,1 □ 722552 (-) 0,1,2 □ 722553	0,8 □ 722556 (-) 0,1 □ 722552 (-) 0,1,2 □ 722553 NO E.230	0,8 □ 722556 (-) 0,1 □ 722552 (-) 0,1,2 □ 722553	0,8 □ 722556 (-) 0,1 □ 722552 (-) 0,1,2 □ 722553	0,8 □ 742466 0,1 □ 742467 0,1,2 □ 742468
Contact Tips - Tubetti di contatto - Tubes contact - Tubitos de contatto - Kontaktröhrchen - Bicos pñio soldadura	 Flux	0,8 □ 722556 (-) 0,1 □ 722552 (-) 0,1,2 □ 722553	0,8 □ 722556 (-) 0,1 □ 722552 (-) 0,1,2 □ 722553	0,8 □ 722556 (-)* 0,1 □ 722552 (-)* 0,1,2 □ 722553*	-	-	0,1 □ 722552 (-) 0,1,2 □ 722553
Conical Nozzles - Ugelli conici - Becs coniques - Inyectores conicos- konische Gasdüsen - Bocais conicos		□ 722423 (-)	□ 722423 (-)	□ 722685	□ MT 15 □ 722423 (-) □ MT 25 □ 722685	□ 722792	
Thin Headed Nozzles - Ugelli a testa fine - Becs à tête fine - Inyectores cabeza fina - verengte Düsen - Bocais ponta fina		□ 722151	□ 722151	□ 722686	□ MT 15 □ 722151 □ MT 25 □ 722686	□ 722793	
Cylindrical Nozzles - Ugelli cilindrici - Becs cylindriques - Inyectores cilindricos - zylindrische Düsen - Bocais cilindricos		□ 722149 (-)	□ 722149 (-)	□ 722684	□ MT 15 □ 722149 (-) □ MT 25 □ 722684	-	
Riveting Nozzles - Ugelli puntatura chiodi - Becs pointage clous - Inyectores punteado clavos - Nägelpunktendüsen - Bocais para pontos		□ 722672	□ 722672	-	□ 722672	-	
Spot-welding Nozzles - Ugelli puntatura - Becs pointage - Inyectores punteado - Punktschweissdüsen - Bocais para pontos		□ 722150	□ 722150	□ 722687	□ MT 15 □ 722150 □ MT 25 □ 722687	-	
Liners	 Fe 3 m ▶	0,6÷0,8 □ 722437 0,1÷1,2 □ 722689	0,6÷0,8 □ 722437 0,1÷1,2 □ 722689	0,6÷0,8 □ 722437 0,1÷1,2 □ 722689	□ MT 15 0,6÷0,8 □ 722437 □ MT 15 0,1÷1,2 □ 722689	0,6÷0,8 □ 722437 0,1÷1,2 □ 722689	
	 Fe 5 m ▶	-	0,6÷0,8 □ 722712 0,1÷1,2 □ 722766	0,6÷0,8 □ 722712 0,1÷1,2 □ 722766	-	0,6÷0,8 □ 722712 0,1÷1,2 □ 722766	
	 Al 4 m ▶	0,1÷1,2 □ 722516 / 0,1÷1,2 □ TECHNOMIG 240, ELECTROMIG 230 □ 742164			□ MT 25 0,1÷1,2 □ 722516	0,1÷1,2 □ 742812	
Torch Swan Necks - Lance - Lances - Encorvados - Brennerhals - Lanças		□ 722305 WITH GAS DIFFUSOR/ CONTACT TIP HOLDER			□ 722696	□ MT 15 □ 722305 □ MT 25 □ 722696	□ 722788
Springs - Molle - Resorts - Muelles - Feder - Molas		□ 722319 (-)	□ 722319 (-)	□ 722319 (-)	□ 722690	□ MT 15 □ 722319 (-) □ MT 25 □ 722690	-
Gas diffusers - Diffusori gas - Diffuseurs gaz - Difusores gas- Gasdiffusoren - Difusores		-	-	-	□ 722688	□ MT 25 □ 722688	□ 722791
Contact Tip Holders - Supporti tubetto - Suports tubes - Sostén tubitos - Kontaktröhrchentraget - Suportes de tubos		-	-	-	-	-	□ 722789
Feed Rolls - Rullini - Galets - Roldanas - Vorschubrollen - Roletes	 Fe	0,6÷0,8/0,9 □ T.210 □ 722019 0,6÷0,9 □ T.180 □ 722529 0,1 □ T.210 □ 722629	0,6÷0,8 □ 742575 0,1÷1,2 □ 742054	2 RULLI 0,6÷0,8 □ 742575 4 RULLI 0,6÷0,8 □ 742576 0,1÷1,2 □ 742366	□ 230, 240, 260 0,6÷0,8 □ 742575 0,1÷1,2 □ 742054 □ E.300, 330 0,6÷0,8 □ 742576 0,1÷1,2 □ 742366	0,6÷0,8 □ MT 15 □ 742575 0,1÷1,2 □ MT 15 □ 742054	0,6÷0,8 □ 742576 0,8÷1 □ 722227 0,1÷1,2 □ 742366
	 Al	0,1 □ 722629	0,8÷1 □ 742090	4 RULLI 0,8÷1 □ 742304	□ 230, 240, 260 0,8÷1 □ 742090 □ E.300, 330 0,8÷1 □ 742304 0,1÷1,2 □ 722167	0,1÷1,2 □ MT 25 □ 722167	0,8÷1 □ 742304 0,1÷1,2 □ 722167
	 Flux	0,6÷0,9 □ 722529 0,9÷1,2 □ 722626	0,1÷1,2 □ 722130	4 RULLI 0,1÷1,2 □ 742729	□ E.230, 240, 260 0,1÷1,2 □ 722130 □ E.300, 330 0,1÷1,2 □ 742729	0,1÷1,2 □ MT 15 □ 722130	0,1÷1,2 □ 742729
Consumables box - Box consumabili - Boite consommables - Caja consumables - Verbrauchsmaterialbox - Box Consumíveis		MIG READY BOX C □ 804149 CONSUMABLES □ 804137	MIG READY BOX F □ T.215 □ 804168 CONSUMABLES □ 804137	CONSUMABLES □ 804137	CONSUMABLES □ 804152	CONSUMABLES □ MT 15 □ 804137 □ MT 25 □ 804152	-

PLASMA CUTTING



	NOZZLES	LONG NOZZLES	GOUGING NOZZLES	ELECTRODE	LONG ELECTRODE	SHIELD	PROLONGED SHIELD	GOUGING SHIELD	TORCH SAFETY CAPS	INSULATING DIFFUSORS	OR RINGS	MAGNETIC GUIDES	CIRCULAR CUTTING UNITS	BOXES
TECHNOLOGY PLASMA 41 XT	20A - 804418 40A - 802423 5pcs	802429 5pcs	-	802420 5pcs	802428 5pcs	-	-	-	802425 2pcs	802422 5pcs	-	802143	804169	804415
TECHNOLOGY PLASMA 60 XT	20A - 804418 40A - 802423 60A - 804157 5pcs	802429 5pcs	-	802420 5pcs	802428 5pcs	-	-	-	802425 2pcs	80242 5pcs	-	802143	804169	804417
TECHNOLOGY PLASMA 54 XT KOMPRESSOR	40A - 802423 20A - 804418 5pcs	-	-	802420 5pcs	-	-	-	-	802485 2pcs	802422 5pcs	-	802143	804169	804416
SUPERIOR PLASMA 70	20-50A 804045 70A - 804047 5pcs	20-50A 804046 70A - 804048 5pcs	45A 804062 5pcs	804042 5pcs	804043 5pcs	804050 2pcs	804051 2pcs	45A 804061 3pcs	20A-70A 804049	20A-70A 804044 2pcs	804052 10pcs	-	804059	804108

INDUCTOR 3000

VERTICAL

10V **M8/M10** - 2pcs
801413
14V **M12/M14** - 2pcs
801414
18V **M16/M18** - 2pcs
801604

kit 2 Twister wires 801419

HORIZONTAL

10H **M8/M10** - 2pcs
801416
14H **M12/M14** - 2pcs
801417
18H **M16/M18** - 2pcs
801605

SMART INDUCTOR 5000

CONSUMABLES FOR HEAT TWISTER:

VERTICAL

10V **M8/M10** - 2pcs
801413
14V **M12/M14** - 2pcs
801414
18V **M16/M18** 2pcs
801415

HORIZONTAL

10H **M8/M10** - 2pcs
801416
14H **M12/M14** - 2pcs
801417
18H **M16/M18** 2pcs
801418

kit 2 Twister wires
801419

DIGITAL CAR SPOTTER



801043

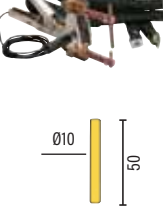

L=50 mm - 690012

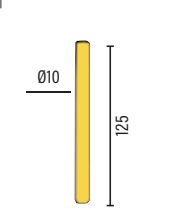

L=125 mm - 690028

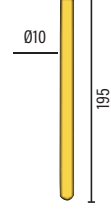

L=195 mm - 690007

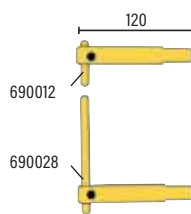

XD1 - standard

L=120 mm - 803015

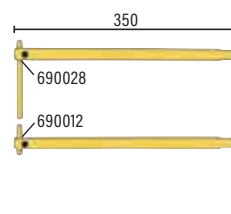

XD2

L=350 mm - 803017

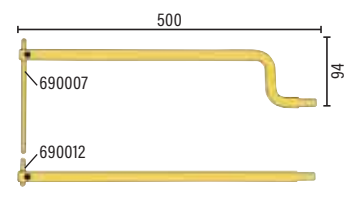

XD3

L=500 mm - 803024

DIGITAL SPOTTER 7000, 9000 (AQUA) - MODULAR 20/TI - DIGITAL MODULAR

ARM PAIRS WITH ELECTRODES - COPPIE BRACCI CON ELETTRODI - DEUX BRAS AVEC ÉLECTRODES - PAR BRAZOS CON ELECTRODOS - ARMPAAR MIT ELEKTRODEN - PAR BRAÇOS PARA PINÇAS COM ELÉTRÓDOS



Digital Spotter 7000, 9000
801048

Digital Spotter 9000 AQUA
801086

- Modular 20/TI
- Digital Modular 230-400

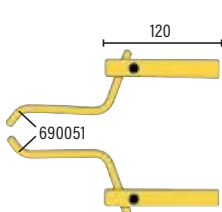

XA4

CLAMP ELECTRODES
L=120 mm - 803155

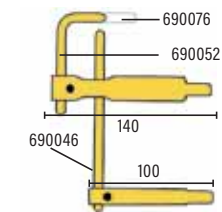

XA5

INTERNAL PROFILES
L=140 mm - 803159

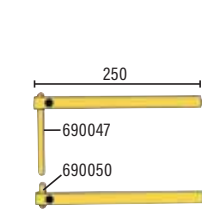

XA6

STRAIGHT ARM PAIR
L=250 mm - 803152

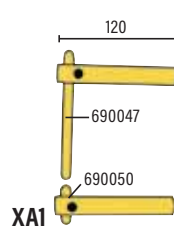

XA1

STRAIGHT ARM PAIR
L=120 mm (standard)
803151

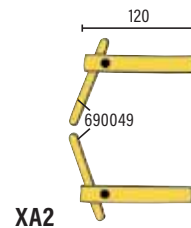

XA2

BENT ARM PAIR
L=120 mm
803150

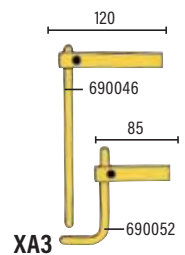

XA3

EXTERNAL PROFILES
L=120 mm
803158

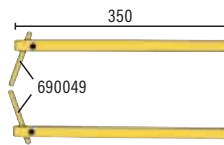

XA7

BENT ARM PAIR
L=350 mm - 803153

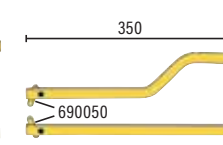

XA8

SHAPED ARM PAIR
L=350 mm - 803154

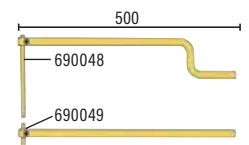

XA9

SHAPED ARM PAIR
L=500 mm - 803156

BASIC ARMS KIT - SERIE BRACCI BASE - KIT BRAS BASE - KIT BRAZOS BASE - GRUNDARMEN KIT - KIT BRAÇOS BASE

803045



90

XA3

XA4

XA6

XA7

XA9

DIGITAL SPOTTER 7000, 9000 (AQUA)



Digital Spotter 7000, 9000
801041

ELECTRODES
L= 28 mm 690055



LEGENDA



V_{PH}	EN Mains voltage IT Tensione di rete FR Tension de secteur ES Tensión de red DE Netzspannung RU Напряжение сети PT Tensão de rede NL Netspanning SV Nätspänning AR جهد الشبكة
V_{DC}	EN Dc available voltage IT Tensione disponibile in DC FR Tension disponible en DC ES Tension disponible in DC DE Dc verfügbare Spannung RU Доступное напряжение в режиме постоянного тока PT Tensão disponível em DC NL Spanning beschikbaar in DC SV Tillgänglig DC-spänning AR الجهد المتاح عند التيار المستمر
A_{60% MAX}	EN Absorbed current IT Corrente assorbita FR Courant absorbé ES Corriente absorbida DE Stromaufnahme RU поглощенный ток PT Corrente absorvida NL Stroomopname SV Strömförbrukning AR التيار الممتص
A_{MAX}	EN Max. current IT Corrente massima FR Courant max. ES Corriente máx. DE Max. Strom RU Максимальный ток PT Corrente máxima NL Maximum stroom SV Maximal ström AR أقصى تيار
A_{TWIC} EN 60335-2-29 1 V	EN Rated charge current IT Corrente di carica convenzionale FR Courant conventionnel de charge ES Corriente de carga convencional DE Konventionalsladestrom RU Ток конвенционального заряда PT Corrente de carga convencional NL Stroom van conventioneel laden SV Ström för normal laddning AR تيار الشحن المدعوم
A_{START MAX}	EN Starting peak current IT Corrente di picco in avviamento FR Courant de pic en démarrage ES Corriente máxima de puesta en marcha DE Startspitzenstrom RU Ликовый ток пуска PT Corrente de pico em accionamento NL Piekstroom in start AR Topström vid start AR أقصى حد للتيار عند التشغيل
A_{EN} EN 60335-2-29	EN Rated charge current IT Corrente di carica convenzionale FR Courant conventionnel de charge ES Corriente de carga convencional DE Konventionalsladestrom RU Ток конвенционального заряда PT Corrente de carga convencional NL Stroom van conventioneel laden SV Ström för normal laddning AR تيار الشحن المدعوم
A_{EFF}	EN Charge current IT Corrente di carica efficace FR Courant de charge ES Corriente de carga DE Ladestrom RU Ток эффективного заряда PT Corrente de carga eficaz NL Stroom van efficiënt laden SV Ström för effektiv laddning AR تيار الشحن الفعال
A_{MAX 49°C} EN 60974-1	EN Max. current IT Corrente massima FR Courant max. ES Corriente máx. DE Max. Strom RU Максимальный ток PT Corrente máxima NL Maximum stroom SV Maximal ström AR أقصى تيار
A_{60% 40°C} EN 60974-1	EN Current at 60% IT Corrente al 60% FR Courant au 60% ES Corriente al 60% DE Strom bei 60% RU Ток на 60% PT Corrente a 60% NL Stroom aan 60% SV Ström vid 60% AR %60 التيار عند
A_{MIN}	EN Current range IT Campo regolazione corrente FR Plage de réglage corrente ES Campo de regulación corriente DE Regelbereich RU Диапазон регулирования тока PT Campo regulação corrente NL Veld regeling stroom SV Område för inställning av växelström AR مجال ضبط التيار
A_{OUT}	EN Output current IT Corrente di uscita FR Courant de sortie ES Corriente de salida DE Ausgangstrom RU Ток выхода PT Corrente de saída NL Uitgangsstroom SV Corrente di uscita AR تيار الخروج
P_{60% MAX}	EN Absorbed power IT Potenza assorbita FR Puissance absorbée ES Potencia absorbida DE Leistungsaufnahme RU Поглощенная мощность PT Potência absorvida NL Geabsorbeerd vermogen SV Absorberad effekt AR القدرة
P_{50%}	EN Absorbed power at 50% IT Potenza assorbita al 50% FR Puissance absorbée à 50% ES Potencia absorbida al 50% DE Leistungsaufnahme bei 50% RU Поглощенная мощность на 50% PT Potência absorvida al 50% NL Geabsorbeerd vermogen aan 50% SV Absorberad effekt vid 50% AR القدرة الممتصة عند 50%
P_{MAX}	EN Max. absorbed power IT Potenza assorbita max. FR Puissance max. absorbée ES Potencia absorbida máx. DE Max. Leistungsaufnahme RU Макс. поглощенная мощность PT Potência absorvida máx NL Max. geabsorbeerd vermogen SV Maximal absorberad effekt AR أقصى قدرة ممتصة
P_{GIS}	EN Charge/Start absorbed power IT Potenza assorbita carica/avviamento FR Puissance absorbée de charge et de démarrage ES Potencia absorbida de carga y de puesta en marcha DE Leistungsaufnahme Auflade/Start RU Поглощенная мощность заряда/зачука PT Potência absorvida de carga/acionamento NL Geabsorbeerd vermogen laden/start SV Absorberad effekt Laddnings-/start AR القدرة الممتصة عند الشحن / التشغيل
P	EN Power IT Potenza FR Puissance ES Potencia DE Leistung RU мощность PT Potência NL Vermogen SV Effekt AR القدرة
P_{DC}	EN DC available power IT Potenza disponibile in DC FR Puissance disponible en DC ES Potencia disponible en DC DE Dc verfügbare Leistung RU Доступная мощность в режиме постоянного тока PT Potência disponível em DC NL Vermogen beschikbaar in DC SV Tillgänglig DC-effekt AR القدرة المتاحة عند التيار المستمر
P_{MAX}	EN Min. motor-generator power IT Potenza min. generatore FR Puissance min. moteur/générateur ES Potencia min. motor/generador DE Min. Generatoraggregate leistung RU Минимальная мощность генератора PT Potência min. gerador NL Min. vermogen generator SV Generators minimeffekt AR الحد الأدنى من القدرة المتاحة للمولد
P_{MAX OUT}	EN Maximum output power IT Potenza massima in uscita FR Puissance maximale en sortie ES Potencia máxima en salida DE Höchstleistung am Ausgang RU Максимальная выходная мощность PT Potência max saída NL Maximum vermogen in uitgang SV Maximal utgångseffekt AR الحد الأقصى لخرج فرق وحرق
C	EN Capacity IT Capacità FR Capacité ES Capacidad DE Kapazität RU Объем IT Capacidade NL Capaciteit SV Kapacitet AR القدرة
C_{MIN/MAX}	EN Rated reference capacity IT Capacità nominale di riferimento FR Capacité nominale de référence ES Capacidad nominal de referencia DE Einheitseinstellung RU Объем резервуара PT Capacidade nominal de referência NL Nominale referentiecapaciteit SV Nominell referenskapacitet AR السعة الاسمية التي يتم الرجوع اليها
F_{OUT}	EN Output frequency IT Frequenza di uscita FR Fréquence de sortie ES Frecuencia de salida DE Ausgangsfrequenz RU Частота выхода PT Frequência de saída NL Uitgangsfrequentie SV Utfrekvens AR تردد الخروج
JFL	EN Invert er frequency IT Frequenza inverter FR Fréquence inverter ES Frecuencia inverter DE Inverter Frequenz RU Частота инвертера PT Frequência inversor NL Frequentie inverter SV Omriktarens utfrekvens AR تردد المحول
V_{IN}	EN Input voltage IT Tensione in ingresso FR Tension en entrée ES Tensión de entrada DE Eingangsspannung RU Напряжение на входе PT Tensão de entrada NL Ingangsspanning SV Inspänning AR الجيد في الدخول
V₀	EN Max. no load voltage IT Tensione a vuoto max. FR Tension a vide max. ES Tension en vacío max. DE Max. Leerlaufspannung RU Макс. холостое напряжение PT Tensão em vazio max. NL Max. spanning leeg SV Max tomgångsspänning AR قدرة البطارية

V_{OUT}	EN Output voltage IT Tensione di uscita FR Tension de sortie ES Tensión de salida DE Ausgangsspannung RU Напряжение на выходе PT Tensão de saída NL Uitgangsspanning SV Utspänning AR جهد الخروج
START	EN Charge/starter voltage IT Tensione di carica/avviamento FR Tension de charge et de démarrage ES Tensión de carga y de puesta en marcha DE Auflade und Anlasespannung RU Напряжение заряда/зачука PT Tensão de carga/acionamento NL Spanning laden/start SV Laddnings-/startspänning AR جهد الشحن/التشغيل
Ø_{DC MIN/MAX}	EN MMA Electrode diameter IT Diametro elettrodi MMA FR Diamètre électrodes MMA ES Diámetro electrodos MMA DE MMA Elektrodendurchmesser RU Диаметр электрода MMA PT Diámetro electrodos MMA NL Diameter elektroden MMA SV Diameter MMA-elektroder AR قطر المسلك الأيونومي لالة اللحام
ØAL	EN Aluminium welding wire diameter IT Diametro filo di saldatura alluminio FR Diamètre fil de soudage aluminium ES Diámetro hilo de soldadura aluminio DE Aluminium Schweissdraht Durchmesser RU Диаметр проволоки для сварки алюминия PT Diámetro do fio de soldadura do alumínio NL Diameter aluminium lasdraad SV Diameter på svetsstråd aluminium AR قطر المسلك الخاص باللمحام
ØBZ	EN Brazing wire diameter IT Diametro filo per brasatura FR Diamètre fil pour brasage ES Diámetro hilo de cobresoldadura DE Lötlendraht Durchmesser RU Диаметр проволоки для пайки PT Diámetro do fio para brasagem NL Diameter draad voor hardsolderen SV Diameter på svetsstråd för lödning AR قطر المسلك الخاص باللمحام بالحارارة
ØFX	EN Flux welding wire diameter IT Diametro filo saldatura animato FR Diamètre fil de soudage fourré ES Diámetro hilo de soldadura halma DE Füll-Schweißdraht Durchmesser RU Диаметр проволоки для сварки порошковой проволокой PT Diámetro do fio de soldadura com alma NL Diameter gevulde lasdraad SV Diameter på fylld svetsstråd AR قطر المسلك المتحرك
ØSS	EN Stainless steel welding wire diameter IT Diametro filo saldatura inox FR Diamètre fil de soudage inox ES Diámetro hilo de soldadura acero inoxidable DE Edelstahl Schweissdraht Durchmesser RU Диаметр проволоки для сварки нержавеющей стали PT Diámetro do fio de soldadura inox NL Diameter roestvrije lasdraad SV Diameter på svetsstråd inox AR قطر مسلك لحام الاستانلس اسيتل
ØST	EN Steel welding wire diameter IT Diametro filo saldatura acciaio FR Diamètre fil de soudage acier ES Diámetro hilo de soldadura acero DE Stahl Schweissdraht Durchmesser RU Диаметр проволоки для сварки стали PT Diámetro do fio de soldadura aço NL Diameter stalen lasdraad SV Diameter på svetsstråd stål AR قطر مسلك لحام الحديد
EN	EN Mains fuse IT Fusibile di rete FR Fusible au reseau ES Fusible de red DE Netzsicherung RU Предохранитель сети PT Fusível de rede NL Netzekering SV Nätsäkring AR فيوز الشبكة
EN	EN Max electrode force IT Forza massima agli elettrodi FR Force max. électrodes ES Fuerza max electrodos DE Max Elektrodenkraft RU Максимальная сила на электродах PT Forza máxima aos electrodos NL Maximum kracht naar de elektroden SV Maximal kraft på elektroder AR أقصى قوة للأقطاب الكهربائية
EN	EN Arms projection IT Sporgenza bracci FR Dimensions Bras ES Largo de los brazos DE Armausladung RU Выступ плеч PT Projecção braços NL Uitstekend gedeelte armen SV Utsprång armar AR بروز الأذرع
EN	EN Max. spot-welding thickness on two sides IT Spessore massimo puntatura 2 lati FR Épaisseur de pointage max. de 2 côtés ES Espesor máx. de punteado sobre 2 lados DE Max. Punktschweißdicke von 2 Seiten RU Максимальная толщина контактной сварки с 2 сторон PT Espessura máxima soldadura por pontos 2 lados NL Maximum dikte puntlassen 2 kanten SV Maximal tjocklek håftsjetsning 2 sidor AR أقصى سمك لسن اللحام ذو الحدين
EN	EN Max. cutting thickness IT Spessore taglio massimo FR Épaisseur de découpage max. ES Espesor máx. de corte DE Max. Schnittstärke RU Толщина максимальной резки PT Espessura máxima de corte NL Maximum snijdikte SV Maximal skärjtjocklek AR أقصى سمك لسن اللحام ذو الحدين
EN	EN Compressed air capacity IT Portata aria compressa FR Débit air comprimé ES Caudal aire comprimido DE Druckluftdurchsatz RU Поток сжатого воздуха PT Caudal ar comprimido NL Vermogen perslucht SV Kapacitet tryckluft AR سعة الخزان
EN	EN Compressed air pressure IT Pressione aria compressa FR Pression air comprimé ES Presión aire comprimido DE Druckluft RU Давление сжатого воздуха PT Pressão ar comprimido NL Druk perslucht SV Tryck tryckluft AR أقصى ضغط للهواء المضغوط
Es	EN Spot Energy IT Energia di puntatura FR Energie de pointage ES Energia de punteado DE Punktschweißenergie RU Энергия точечной сварки PT Energia de soldadura por pontos NL Energie van puntlassen SV Energi till punktsvetsning AR قوة اللحام بالنس
Ts	EN Spot time IT Tempo di puntatura FR Temps de pointage ES Tiempo de punteado DE Punktschweißzeit RU Время точечной сварки PT Tempo de soldadura por pontos NL Tijd van puntlassen SV Punktstvetstid AR زمن اللحام بالنس
DUTY CYCLE	EN Duty cycle IT Rapporto di intermittenza FR Facteur de marche ES Ciclo de servicio DE Einschaltdauer RU Соотношение прерывистости PT Relação de intermitência NL Verhouding van intermittentie SV Intermittensfaktor AR نسبة التناوب
Ø	EN Spottable stud diameter IT Diametro perni puntatili FR Diametre goujons pour pointage ES Diametro pernos a puntar DE Durchmesser Aufpunktbarer Bolzen RU Диаметр привариваемых штырей PT Diámetro dos pinos para soldadura por pontos NL Diameter stiften die gepuntlast kunnen worden SV Diameter på bultar för punktsvets AR قطر محاور اللحام بالنس
#	EN Number spottable studs IT Numero perni puntatili FR Nombre goujons pour pointage ES Numero de pernos a puntar DE Anzahl Aufpunktbarer Bolzen RU Количество привариваемых штырей PT Número dos pinos para soldadura por pontos NL Aantal stiften die gepuntlast kunnen worden SV Antal bultar för punktsvets AR عدد محاور اللحام بالنس
EN	EN Adjustment positions IT Posizioni di regolazione FR Positions de réglage ES Posiciones de regulación DE Schaltstufen RU Положение регулирования PT Posições de regulação NL Posities van regeling SV Justeringslägen AR أوضاع الضبط
ηφ	EN Efficiency / Power factor IT Rendimento / Fattore di potenza FR Rendement / Facteur de puissance ES Rendimiento / Factor de potencia DE Leistung / Leistungsfaktor RU Отдача / Фактор мощности PT Rendimento/Factor de potência NL Rendement/Factor van vermogen SV Verkningsgrad/effektfaktor AR المردود / عامل القدرة
EN	EN Light/dark delay IT Ritardo scuro/chiaro FR Retard obscur/clair ES Retraso oscuro/claro DE Verzögerung dunkel/hell RU Задержка затемнения/прозрачный PT Atraso escuro/claro NL Vertraging donker/helder SV Fördörning mörk/ljus AR فوتورلا حوض / فوتوغتل ريثاك
me	EN Darkening speed IT Velocità oscuramento FR Vitesse d'obscurissement ES Velocidad oscurecimiento DE Verdunkelungsgeschwindigkeit RU Скорость затемнения PT Velocidade escurecimento NL Snelheid verduistering SV Förmörkningshastighet AR فوتوغتل عرس
DIN	EN Light state IT Stato chiaro FR État clair ES Estado claro DE Heller Zustand RU Прозрачное состояние PT Estado claro NL Heldere staat SV Ljus status AR فوتورلا حوض / فوتوغتل
DIN	EN Dark state IT Stato scuro FR État obscur ES Estado oscuro DE Dunkler Zustand RU Затемненное состояние PT Estado escuro NL Donkere staat SV Mörk status AR فوتوغتل / فوتوغتل

The manufacturer does not accept any responsibility for any typing or printing errors in this catalogue. It also reserves the right to make any alterations or modifications deemed necessary at any time, without altering or interfering with the basic functions of the apparatus.

La Società Produttrice declina ogni responsabilità per le possibili inesattezze contenute nel presente catalogo, imputabili ad errori di stampa o di trascrizione. Si riserva altresì il diritto di apportare, senza preavviso, ai propri prodotti quelle modifiche che ritenesse necessarie ed utili senza pregiudicare le caratteristiche di utilizzo.

TELWIN[®]

SINCE 1963

GO
FURTHER

JOIN THE INNOVATION

